



# LISTINO PREZZI PROVVISORIO

Prix liste provisoire

Price list provisional

n°02-02/15



# STUDIOFFICE

INDICE  
INDEX  
INDEX

**DIVO 7**

**DELUXE 23**

**TRILOGY 47**

**QUADRA 83**

**TAU 111**

**OPEN WORK 131**

**SMART ACCESSORI 141**

SOTTOMANI E PORTA PC - *WORKIN PAD AND CPU HOLDER* - SOUS-MAIN ET PORTE PC  
PANNELLI FRONTALI/LATERALI - *FRONTAL/LATERAL PANELS* - PANNEAU LATERALE/FRONTALE  
ACCESSORI - *ACCESSORIES* - ACCESSOIRES  
PORTA MONITOR E LAMPADE - *SCREEN HOLDER AND LAMPS* - PORTE MONITOR ET LAMPES

**SMART LOUNGE 157**

**SMART CONFERENCE 160**

**CONTENITORI E MOBILI - *CABINETS* - ARMOIRES ET DESSERTES 163**

CASSETTIERE E PORTA CPU - *DRAWERS AND CPU SUPPORTS* - CAISSONS ET CPU PORTEURS  
MOBILI DI SERVIZIO - *SERVICE CABINETS* - MEUBLES DE SERVICE  
CONTENITORI - *CABINETS* - ARMOIRES  
CONTENITORI SCORREVOLI - *CABINETS WITH SLIDING DOORS* - ARMOIRES AVEC PORTES COULISSANTES  
MOBILI MULTIFUNZIONE - *MULTIFUNCTIONAL CABINETS* - MEUBLES MULTI-FONCTION

**CONTENITORI E MOBILI METALLICI- *METAL CABINETS* - ARMOIRES METALLIQUES 193**

<b>01 PLUS</b>	CONTENITORI ANTE BATTENTI E CLASSIFICATORI - <i>CABINETS WITH SWING DOORS AND FILING</i> - ARMOIRES AVEC PORTES BATTANTE ET CLASSEURS MOBILE
<b>02</b>	CONTENITORI ANTE BATTENTI E SCORREVOLI- <i>METAL CABINETS WITH SWING AND SLIDING DOORS</i> - ARMOIRES METALLIQUES AVEC PORTES BATTANTE ET COULISSANTES
<b>03</b>	CASSETTIERE E CLASSIFICATORI SU RUOTE - <i>MOBILE DRAWER AND FILING</i> - CAISSONS ET CLASSEURS SUR ROULETTES



# FINITURE

Finishes - finitions

# STUDIOFFICE

## STRUTTURE SCRIVANIE - DESKS STRUCTURES - STRUCTURES DE BUREAUX

01	<b>BI</b> Bianco White Blanc	02	<b>AL</b> Alluminio Aluminium Aluminium	03	<b>GA</b> Grigio antracite Anthracite grey Gris anthracite	04	<b>NR</b> Nero lucido Gloss black Noir brillant	05	<b>CR</b> Cromato Chrome Chrome
----	---------------------------------------	----	--	----	---	----	--	----	--

## NOBILITATI Sp.18/25 mm. - MELAMINE Th.18/25 mm - MELAMINE Sp.18/25 mm.

06	<b>BI</b> Bianco White Blanc	07	<b>GAV</b> Grigio Avorio Ivory grey Gris ivoire	08	<b>GTO</b> Grigio tortora Dove grey Gris torturelle	09	<b>NR</b> NERO Black Noir	10	<b>RSB</b> Rovere chiaro Light Oak Chêne clair	11	<b>RM</b> Rovere moka Moka Oak Chêne moka	12	<b>OL</b> Olmo Elm Orme	13	<b>NCA</b> Noce canaletto Canaletto Walnut Noyer canaletto	14	<b>AL</b> Alluminio Aluminium Aluminium
15	<b>RS</b> Rosso Red Rouge	16	<b>GL</b> Giallo Yellow Jaune	17	<b>AZ</b> Azzurro Light blue Bleu	18	<b>VD</b> Verde Green Vert										

## VETRO - GLASSES - VERRES

19	<b>VN</b> Vetro nero Black glass Verre noir	20	<b>VB</b> Vetro bianco White glass Verre blanc	21	<b>VC</b> Vetro cioccolato Chocolate glass Verre chocolat	22	<b>VR</b> Vetro rosso Red glass Verre rouge	23	<b>VS</b> Vetro satinato Satinated glass Verre satiné
----	--	----	---	----	--	----	--	----	--

## TESSUTI - FABRICS - TISSUS

25	<b>GR(629)</b> Grigio Grey Gris	26	<b>AV(532)</b> Avorio Grey Ivoire	31	<b>VD(425)</b> Verde Green Vert	33	<b>GL(53)</b> Giallo Yellow Jaune	33	<b>AZ(386)</b> Azzurro Light blue Bleu	36	<b>RS(236)</b> Rosso Red Rouge
----	--	----	--	----	--	----	--	----	---	----	---

## POLICARBONATO - POLYCARBONATE - POLYCARBONATE

37	<b>BI</b> Bianco White Blanc	38	<b>RS</b> Rosso Red Rouge	39	<b>GL</b> Giallo Yellow Jaune	40	<b>BT</b> Bottiglia light green Vert clair
----	---------------------------------------	----	------------------------------------	----	--	----	---

## CONTENITORI METALLICI- METAL CABINETS - MEUBLES EN METAL

41	<b>BI(9010)</b> Bianco White Blanc	42	<b>NR(9005)</b> Nero Black Noir	43	<b>GR(7035)</b> Grigio Grey Gris	44	<b>AL(9006)</b> Alluminio Aluminium Aluminium	45	<b>GTO(7044)</b> Grigio tortora Dove grey Gris torturelle
----	---	----	--	----	---	----	--	----	--



# STUDIOFFICE

## DIVO



### STRUTTURE SCRIVANIE

Il basamento metallico è realizzato con due elementi a sezione rettangolare nella parte superiore e inferiore, la parte verticale è composta da elementi a forma ellittica. Disponibile nelle finiture cromate o verniciate con polveri epossidiche nei colori alluminio, nero lucido e bianco. La parte superiore è composta da un solido aggancio mediante travi metalliche che assicurano la stabilità dell'intera struttura.

### DESKS STRUCTURES

*Metallic base is made out of two rectangular shaped elements on the upper and lower part. The vertical frame is made out of elliptical shaped elements. Basement is available in chromed and epossidic paint aluminium, gloss black, white varnishes. The upper part is characterised by a solid hook through metallic beam which gives stability to the whole structure.*

### STRUCTURES DES BUREAUX

Le piètement métallique se compose de deux éléments rectangulaires dans la partie supérieure et inférieure; la partie verticale est composée d'éléments de forme elliptique. Disponible en finition chromée ou laqué aluminium, noir brillant et blanc. Les plans sont liés aux pieds par des poutres métalliques qui donnent stabilité à la structure entière

01	<b>BI</b> Bianco White Blanc	02	<b>AL</b> Alluminio Aluminium Aluminium	04	<b>NR</b> Nero lucido Gloss black Noir brillant	05	<b>CR</b> Cromato Chrome Chrome
----	---------------------------------------	----	--	----	--	----	--

**\*DIVO può essere completato con cassettiere, mobili di servizio, contenitori ed accessori consultabili nelle rispettive sezioni da pag. 141 a seguire.**

*\*DIVO can be completed with drawers, service cabinets, cabinets and accessories to be found in the respective sections from page 141 on*

*\*DIVO peut être complété avec caissons mobiles, des meubles de service, des armoires et accessoires disponibles dans les sections correspondantes à partir de la page 141 à suivre*

# DIVO

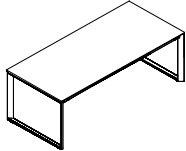
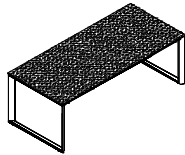
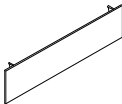
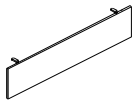
SCRIVANIE DIREZIONALI P.90 EXECUTIVE DESKS D.90 BUREAUX DIRECTION P.90	CODICE CODE CODE	FINITURA PIANI TOP FINISHING FIN. PLANS	FINITURA GAMBE LEG FINISHING FINITION PIEDS	L x P x H W x D x H L x P x H	COLLI PACKS COLIS	VOLUMI VOLUME VOLUME	PESO WEIGHT POIDS	PREZZO PRICE PRIX		
								€		
 <p><b>Scrivania piano legno</b> <i>Desk with wooden top</i> Poste avec plan mélaminé</p>	SOD370	NCA RM RSB OL GAV GTO BI	AL BI NR	180 x 90 x 73	3	0,216	48,7	829,00		
			CR					1.189,00		
	SOD371		AL BI NR	200 x 90 x 73	3	0,224	52,7	854,00		
			CR					1.218,00		
	SOD372		AL BI NR	220 x 90 x 73	3	0,233	56,7	879,00		
			CR					1.250,00		
	 <p><b>Scrivania piano vetro</b> <i>Desk with glass top</i> Poste avec plan en verre</p>		SOD370V	VS	AL BI NR	180 x 90 x 73	3	0,248	69,8	1.552,00
					CR					1.912,00
					VN VB VC VR					AL BI NR
CR		2.174,00								
SOD371V		VS	AL BI NR	200 x 90 x 73	3	0,260	76,1	1.608,00		
			CR					1.971,00		
		VN VB VC VR	AL BI NR					1.917,00		
			CR					2.281,00		
SOD372V		VS	AL BI NR	220 x 90 x 73	3	0,272	82,5	1.686,00		
			CR					2.057,00		
	VN VB VC VR	AL BI NR	1.998,00							
		CR	2.370,00							
 <p><b>Modesty panel per scrivanie legno</b> <i>Modesty panel for wooden desks</i> Voile de fond pour plan mélaminé</p>	S0605	NCA RM	Per SOD370 For SOD370 POUR SOD370	L.168 x H.28,4	2	0,020	7,5	63,00		
	S0606	RSB OL GAV	Per SOD371 For SOD371 POUR SOD371	L.188 x H.28,4	2	0,023	8,3	67,00		
	S0607	GTO BI	Per SOD372 For SOD372 POUR SOD372	L.208 x H.28,4	2	0,025	9,0	70,00		
 <p><b>Modesty panel per scrivanie vetro</b> <i>Modesty panel for glass desks</i> Voile de fond pour plan en verre</p>	S0605V	NCA RM	Per SOD370V For SOD370V POUR SOD370V	L.168 x H.28,4	1	0,020	7,5	63,00		
	S0606V	RSB OL GAV	Per SOD371V For SOD371V POUR SOD371V	L.188 x H.28,4	1	0,023	8,3	67,00		
	S0607V	GTO BI	Per SOD372V For SOD372V POUR SOD372V	L.208 x H.28,4	1	0,025	9,0	70,00		



# DIVO



Da completare sempre con mobili di servizio portanti L.160-180 (PAG.169)

To be completed always with load bearing service cabinet L.160-180 (PAGE 169)

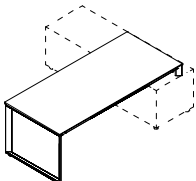
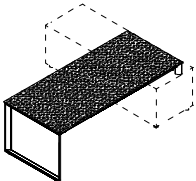
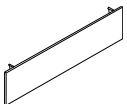
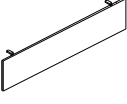
A compléter toujours avec meubles porteurs L.160-180 (PAGE 169)

SCRIVANIE DIREZIONALI PORTANTI P.90 LOAD BEARING EXECUTIVE DESKS D.90 BUREAUX DIRECTION PORTEURS P.90	CODICE CODE CODE	FINITURA PIANI TOP FINISHING FIN. PLANS	FINITURA GAMBE LEG FINISHING FINITION PIEDS	L x P x H W x D x H L x P x H	COLLI PACKS COLIS	VOLUMI VOLUME VOLUME	PESO WEIGHT POIDS	PREZZO PRICE PRIX	
								€	
 <p><b>Scrivania piano legno</b> <i>Desk with wooden top</i> Poste avec plan mélaminé</p>	SOD370P	NCA	AL	180 x 90 x 73	3	0,216	45,8	793,00	
			BI					1.099,00	
	SOD371P	RM	AL	200 x 90 x 73	3	0,224	49,8	818,00	
			BI					1.128,00	
	SOD372P	RSB	AL	220 x 90 x 73	3	0,233	53,8	843,00	
			BI					1.160,00	
	 <p><b>Scrivania piano vetro</b> <i>Desk with glass top</i> Poste avec plan en verre</p>	SOD370PV	VS	AL	180 x 90 x 73	3	0,248	66,9	1.516,00
				BI					1.822,00
		SOD371PV	VN	AL	200 x 90 x 73	3	0,260	73,2	1.778,00
BI				2.084,00					
SOD372PV		VC	AL	220 x 90 x 73	3	0,272	79,6	1.572,00	
			BI					1.881,00	
SOD370PV		VR	AL	200 x 90 x 73	3	0,260	73,2	1.881,00	
			BI					1.881,00	
			NR					2.191,00	
SOD371PV	VR	AL	200 x 90 x 73	3	0,260	73,2	1.572,00		
		BI					1.881,00		
		NR					2.191,00		
SOD372PV	VR	AL	220 x 90 x 73	3	0,272	79,6	1.650,00		
		BI					1.967,00		
		NR					1.962,00		
SOD370PV	VR	AL	220 x 90 x 73	3	0,272	79,6	2.280,00		
		BI					1.962,00		
		NR					2.280,00		
 <p><b>Modesty panel per scrivanie legno</b> <i>Modesty panel for wooden desks</i> Voile de fond pour plan mélaminé</p>	S0603	NCA	Per SOX370 For SOX370 POUR SOX370	L.128 x H.28,4	2	0,016	5,9	56,00	
	S0604	RM	Per SOX371 For SOX371 POUR SOX371	L.148 x H.28,4	2	0,018	6,7	60,00	
	S0605	RSB	Per SOX372 For SOX372 POUR SOX372	L.168 x H.28,4	2	0,020	7,5	63,00	
 <p><b>Modesty panel per scrivanie vetro</b> <i>Modesty panel for glass desks</i> Voile de fond pour plan en verre</p>	S0603V	GAV	Per SOX370V For SOX370V POUR SOX370V	L.128 x H.28,4	1	0,016	5,9	56,00	
	S0604V	OL	Per SOX371V For SOX371V POUR SOX371V	L.148 x H.28,4	1	0,018	6,7	60,00	
	S0605V	GTO	Per SOX372V For SOX372V POUR SOX372V	L.168 x H.28,4	1	0,020	7,5	63,00	

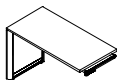



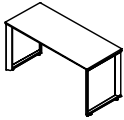
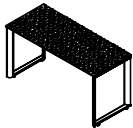

# DIVO

ALLUNGHI LATERALI E FRONTALI LATERAL AND FRONTAL EXTENSIONS EXTENSIONS LATERALES ET FRONTALES	CODICE CODE CODE	FINITURA PIANI TOP FINISHING FIN. PLANS	FINITURA GAMBE LEG FINISHING FINITION PIEDS	L x P x H W x D x H L x P x H	COLLI PACKS COLIS	VOLUMI VOLUME VOLUME	PESO WEIGHT POIDS	PREZZO PRICE PRIX			
								€			
 <p><b>Allungo laterale o frontale per piani legno</b> <i>Lateral or frontal extension for wooden desks</i> Extension laterale et frontale pour poste mélaminé</p>	SOD312	NCA RM RSB OL GAV GTO BI	AL	90 x 60 x 73	4	0,768	19,4	471,00			
			BI					629,00			
	NR		100 x 60 x 73	4	0,771	20,9	477,00				
	CR						637,00				
	SOD313		AL	120 x 60 x 73	4	0,777	23,5	488,00			
			BI					649,00			
	SOD314		NR	140 x 60 x 73	4	0,783	40,9	500,00			
			CR					661,00			
	 <p><b>Allungo laterale o frontale per piani legno/vetro</b> <i>Lateral or frontal extension for wooden/glass desks</i> Extension laterale et frontale pour poste mélaminé/verre</p>		SOD312V	VS	AL	90 x 60 x 73	4	0,780	26,4	792,00	
					BI					951,00	
				NR	905,00						
				CR	1.064,00						
			SOD313V	VN	VS	AL	100 x 60 x 73	4	0,784	28,3	817,00
						BI					977,00
				NR	952,00						
CR		1.112,00									
SOD314V		VB	VS	AL	120 x 60 x 73	4	0,793	32,8	855,00		
				BI					1.015,00		
		NR	999,00								
		CR	1.159,00								
SOD315V		VC	VS	AL	140 x 60 x 73	4	0,801	37,0	901,00		
				BI					1.063,00		
		NR	1.090,00								
	CR	1.252,00									

# DIVO

TAVOLI DATTELO TYPING DESKS TABLES DACTYLO	CODICE CODE CODE	FINITURA PIANI TOP FINISHING FIN. PLANS	FINITURA GAMBE LEG FINISHING FINITION PIEDS	L x P x H W x D x H L x P x H	COLLI PACKS COLIS	VOLUMI VOLUME VOLUME	PESO WEIGHT POIDS	PREZZO PRICE PRIX		
								€		
 <p><b>Tavolo dattilo piano legno</b> Typing desk with wooden top Table dactylo avec plan mélaminé</p>	SOD312D	NCA RM RSB OL GAV GTO BI	AL BI NR	90 x 60 x 73	4	1,492	24,6	764,00		
			CR					1.013,00		
	SOD313D		AL BI NR	100 x 60 x 73	4	1,495	26,1	770,00		
			CR					1.020,00		
	SOD314D		AL BI NR	120 x 60 x 73	4	1,501	28,7	781,00		
			CR					1.032,00		
	SOD315D		AL BI NR CR	140 x 60 x 73	4	1,507	31,3	793,00		
								1.045,00		
	 <p><b>Tavolo dattilo piano vetro</b> Typing desk with glass top Table dactylo avec plan en verre</p>		SOD312DV	VS	AL BI NR	90 x 60 x 73	4	1,504	31,6	1.085,00
					CR					1.335,00
				VN VB VC VR	AL BI NR					1.198,00
					CR					1.447,00
SOD313DV		VS	AL BI NR	100 x 60 x 73	4	1,508	33,5	1.110,00		
			CR					1.360,00		
		VN VB VC VR	AL BI NR					1.245,00		
			CR					1.495,00		
SOD314DV		VS	AL BI NR	120 x 60 x 73	4	1,516	38,0	1.148,00		
			CR					1.399,00		
		VN VB VC VR	AL BI NR					1.292,00		
			CR					1.543,00		
SOD315DV		VS	AL BI NR	140 x 60 x 73	4	1,525	42,2	1.194,00		
			CR					1.446,00		
		VN VB VC VR	AL BI NR					1.383,00		
			CR					1.635,00		

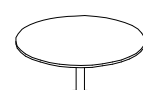
# DIVO

TAVOLI RIUNIONE MEETING TABLES TABLES DE REUNION	CODICE CODE CODE	FINITURA PIANI TOP FINISHING FIN. PLANS	FINITURA GAMBE LEG FINISHING FINITION PIEDS	L x P x H W x D x H L x P x H	COLLI PACKS COLIS	VOLUMI VOLUME VOLUME	PESO WEIGHT POIDS	PREZZO PRICE PRIX			
								€			
 <b>Tavolo circolare diam.90 piano legno (4 posti)</b> <i>Round meeting table D.90 with wooden top (4 seats)</i> Table de réunion ronde D.90 avec plan mélaminé (4 Places)	S0721	NCA RM RSB OL GAV GTO BI	AL	Diam.90 H.75,5	3	0,081	31,4	347,00			
			BI					NR	XL	472,00	
 <b>Tavolo circolare diam.90 piano vetro (4 posti)</b> <i>Round meeting table D.90 with glass top (4 seats)</i> Table de réunion ronde D.90 avec plan en verre (4 Places)	S0721V	VS  VN VB VC VR	AL	Diam.90 H.74,2	3	0,098	39,7	741,00			
			BI					NR	XL	866,00	
			AL					BI	NR	XL	899,00
			VR					XL			1.024,00
 <b>Tavolo riunione 90x90 piano legno (4 posti)</b> <i>Meeting table 90x90 with wooden top (4 seats)</i> Table de réunion 90x90 avec plan mélaminé (4 Places)	S0721.1	NCA RM RSB OL GAV GTO BI	AL	90 x 90 x 75,5	3	0,075	33,4	374,00			
			BI					NR	XL	511,00	
 <b>Tavolo riunione 90x90 piano vetro (4 posti)</b> <i>Meeting table 90x90 with glass top (4 seats)</i> Table de réunion 90x90 avec plan en verre (4 Places)	S0721.V	VS  VN VB VC VR	AL	90 x 90 x 74,2	3	0,092	41,7	768,00			
			BI					NR	XL	905,00	
			AL					BI	NR	XL	926,00
			VR					XL			1.062,00
 <b>Tavolo circolare diam.120 piano legno (4 posti)</b> <i>Round meeting table D.120 with wooden top (4 seats)</i> Table de réunion ronde D.120 avec plan mélaminé (4 Places)	S0722	NCA RM RSB OL GAV GTO BI	AL	Diam.120 H.75,5	3	0,126	56,4	560,00			
			BI					NR	XL	590,00	
 <b>Tavolo circolare diam.120 piano vetro (4 posti)</b> <i>Round meeting table D.120 with glass top (4 seats)</i> Table de réunion ronde D.120 avec plan en verre (4 Places)	S0722V	VS  VN VB VC VR	AL	Diam.120 H.74,2	3	0,154	72,1	1.152,00			
			BI					NR	XL	1.182,00	
			AL					BI	NR	XL	1.467,00
			VR					XL			1.497,00

# DIVO

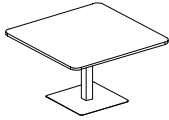
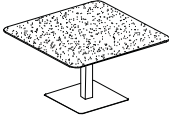
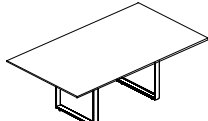
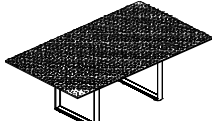
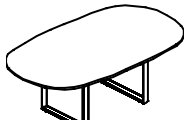
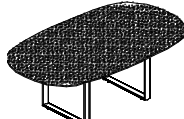
TAVOLI RIUNIONE MEETING TABLES TABLES DE REUNION	CODICE CODE CODE	FINITURA PIANI TOP FINISHING FIN. PLANS	FINITURA GAMBE LEG FINISHING FINITION PIEDS	L x P x H W x D x H L x P x H	COLLI PACKS COLIS	VOLUMI VOLUME VOLUME	PESO WEIGHT POIDS	PREZZO PRICE PRIX
								€
 <p><b>Tavolo riunione 120x120 piano legno (4 posti)</b> <i>Meeting table 120x120 with wooden top (4 seats)</i> Table de réunion 120x120 avec plan mélaminé (4 Places)</p>	S0722.1	NCA RM RSB OL GAV GTO BI	AL BI NR XL	120 x 120 x 75,5	3	0,123	62,4	639,00
		817,00						
 <p><b>Tavolo circolare 120x120 piano vetro (4 posti)</b> <i>Round meeting table 120x120 with glass top (4 seats)</i> Table de réunion ronde 120x120 avec plan en verre (4 Places)</p>	S0722.1V	VS VN VB VC VR	AL BI NR XL	120 x 120 x 74,2	3	0,151	78,1	1.231,00
			1.409,00					
			1.546,00					
			1.724,00					
			1.724,00					
 <p><b>Tavolo riunione L.210 piano legno (6-8 posti)</b> <i>Meeting table W.210 with wooden top (6-8 seats)</i> Table de réunion L.210 avec plan mélaminé (6-8 Places)</p>	S0D705	NCA RM RSB OL GAV GTO BI	AL BI NR CR	210 x 120 x 73	5	0,314	69,0	991,00
			1.421,00					
 <p><b>Tavolo riunione L.210 piano vetro (6-8 posti)</b> <i>Meeting table W.210 with glass top (6-8 seats)</i> Table de réunion L.210 avec plan en verre (6-8 Places)</p>	S0D705V	VS VN VB VC VR	AL BI NR CR	210 x 120 x 73	5	0,361	101,7	1.993,00
			2.423,00					
			2.488,00					
			2.918,00					
			2.918,00					
 <p><b>Tavolo riunione L.210 piano legno (6-8 posti)</b> <i>Meeting table W.210 with wooden top (6-8 seats)</i> Table de réunion L.210 avec plan mélaminé (6-8 Places)</p>	S0D715	NCA RM RSB OL GAV GTO BI	AL BI NR CR	210 x 120 x 73	5	0,314	69,0	1.103,00
			1.533,00					
 <p><b>Tavolo riunione L.210 piano vetro (6-8 posti)</b> <i>Meeting table W.210 with glass top (6-8 seats)</i> Table de réunion L.210 avec plan en verre (6-8 Places)</p>	S0D715V	VS VN VB VC VR	AL BI NR CR	210 x 120 x 73	5	0,361	96,5	2.128,00
			2.558,00					
			2.668,00					
			3.098,00					
			3.098,00					

# DIVO

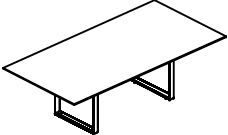
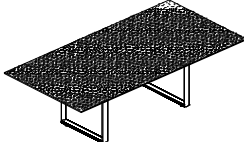
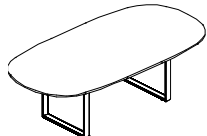
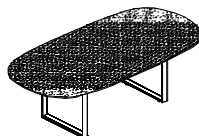
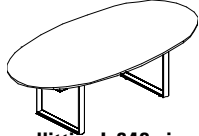
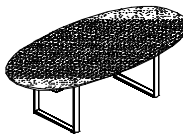
TAVOLI RIUNIONE MEETING TABLES TABLES DE REUNION	CODICE CODE CODE	FINITURA PIAMI TOP FINISHING FIN. PLANS	FINITURA GAMBE LEG FINISHING FINITION PIEDS	L x P x H W x D x H L x P x H	COLLI PACKS COLIS	VOLUMI VOLUME VOLUME	PESO WEIGHT POIDS	PREZZO PRICE PRIX	
								€	
 <b>Tavolo riunione L.240 piano legno (8 posti)</b> <i>Meeting table W.240 with wooden top (8 seats)</i> Table de réunion L.240 avec plan mélaminé (8 Places)	SOD706	NCA RM RSB OL GAV GTO BI	AL	240 x 120 x 73	5	0,331	76,5	1.025,00	
			BI					NR	1.463,00
 <b>Tavolo riunione L.240 piano vetro (8 posti)</b> <i>Meeting table W.240 with glass top (8 seats)</i> Table de réunion L.240 avec plan en verre (8 Places)	SOD706V	VS VN VB VC VR	AL	240 x 120 x 73	5	0,384	114,0	2.112,00	
			BI					NR	2.549,00
			CR					AL	2.742,00
			BI					NR	3.179,00
			CR					CR	3.179,00
 <b>Tavolo riunione L.240 piano legno (8 posti)</b> <i>Meeting table W.240 with wooden top (8 seats)</i> Table de réunion L.240 avec plan mélaminé (8 Places)	SOD716	NCA RM RSB OL GAV GTO BI	AL	240 x 120 x 73	5	0,331	76,5	1.137,00	
			BI					NR	1.575,00
 <b>Tavolo riunione L.240 piano vetro (8 posti)</b> <i>Meeting table W.240 with glass top (8 seats)</i> Table de réunion L.240 avec plan en verre (8 Places)	SOD716V	VS VN VB VC VR	AL	240 x 120 x 73	5	0,384	108,3	2.269,00	
			BI					NR	2.707,00
			CR					AL	2.899,00
			BI					NR	3.337,00
			CR					CR	3.337,00
 <b>Tavolo riunione ellittico L.240 piano legno (8 posti)</b> <i>Elliptical meeting table W.240 with wooden top (8 seats)</i> Table de réunion elliptique L.240 avec plan mélaminé (8 Places)	SOD717	NCA RM RSB OL GAV GTO BI	AL	240 x 120 x 73	5	0,331	76,5	1.137,00	
			BI					NR	1.575,00
 <b>Tavolo riunione ellittico L.240 piano vetro (6-8 posti)</b> <i>Elliptical meeting table W.240 with glass top (6-8 seats)</i> Table de réunion elliptique L.240 avec plan en verre (6-8 Places)	SOD717V	VS VN VB VC VR	AL	240 x 120 x 73	5	0,384	108,3	2.269,00	
			BI					NR	2.707,00
			CR					AL	2.899,00
			BI					NR	3.337,00
			CR					CR	3.337,00

# DIVO

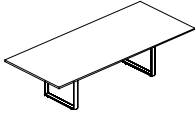
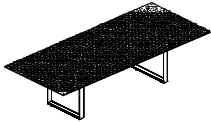
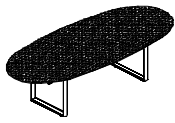
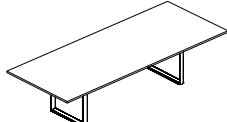
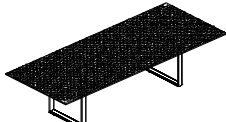
TAVOLI RIUNIONE MEETING TABLES TABLES DE REUNION	CODICE CODE CODE	FINITURA PIANI TOP FINISHING FIN. PLANS	FINITURA GAMBE LEG FINISHING FINITION PIEDS	L x P x H W x D x H L x P x H	COLLI PACKS COLIS	VOLUMI VOLUME VOLUME	PESO WEIGHT POIDS	PREZZO PRICE PRIX
								€
 <p><b>Tavolo riunione L.280 piano legno (8-10 posti)</b> <i>Meeting table W.280 with wooden top (8-10 seats)</i> Table de réunion L.280 avec plan mélaminé (8-10 Places)</p>	<b>SOD708</b>	NCA RM RSB OL GAV GTO BI	AL	280 x 120 x 73	5	0,353	86,2	<b>1.069,00</b>
			CR					<b>1.510,00</b>
 <p><b>Tavolo riunione L.280 piano vetro (8-10 posti)</b> <i>Meeting table W.280 with glass top (8-10 seats)</i> Table de réunion L.280 avec plan en verre (8-10 Places)</p>	<b>SOD708V</b>	VS VN VB VC VR	AL	280 x 120 x 73	5	0,414	129,9	<b>2.388,00</b>
			BI					<b>2.828,00</b>
			NR					<b>3.018,00</b>
			CR					<b>3.458,00</b>
			CR					<b>3.458,00</b>
 <p><b>Tavolo riunione ellittico L.280 piano vetro (10 posti)</b> <i>Elliptical meeting table W.280 with glass top (10 seats)</i> Table de réunion elliptique L.280 avec plan en verre (10 Places)</p>	<b>SOD718V</b>	VS VN VB VC VR	AL	280 x 120 x 73	5	0,414	123,6	<b>2.568,00</b>
			BI					<b>3.008,00</b>
			NR					<b>3.220,00</b>
			CR					<b>3.661,00</b>
			CR					<b>3.661,00</b>
 <p><b>Tavolo riunione L.300 piano legno (10 posti)</b> <i>Meeting table W.300 with wooden top (10 seats)</i> Table de réunion L.300 avec plan mélaminé (10 Places)</p>	<b>SOD709</b>	NCA RM RSB OL GAV GTO BI	AL	300 x 120 x 73	5	0,364	91,6	<b>1.095,00</b>
			CR					<b>1.542,00</b>
 <p><b>Tavolo riunione L.300 piano vetro (10 posti)</b> <i>Meeting table W.300 with glass top (8-10 seats)</i> Table de réunion L.300 avec plan en verre (8-10 Places)</p>	<b>SOD709V</b>	VS VN VB VC VR	AL	300 x 120 x 73	5	0,429	138,4	<b>2.486,00</b>
			BI					<b>2.932,00</b>
			NR					<b>3.206,00</b>
			CR					<b>3.652,00</b>
			CR					<b>3.652,00</b>

# DIVO

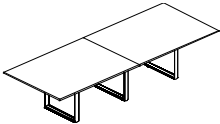
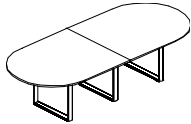
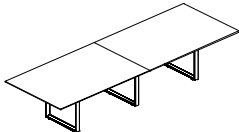
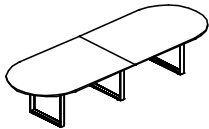
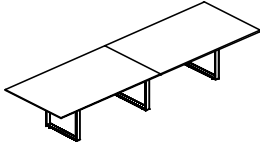
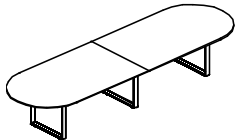
TAVOLI RIUNIONE MEETING TABLES TABLES DE REUNION	CODICE CODE CODE	FINITURA PIANI TOP FINISHING FIN. PLANS	FINITURA GAMBE LEG FINISHING FINITION PIEDS	L x P x H W x D x H L x P x H	COLLI PACKS COLIS	VOLUMI VOLUME VOLUME	PESO WEIGHT POIDS	PREZZO PRICE PRIX
								€
 <p><b>Tavolo riunione L.320 piano legno (10-12 posti)</b> <i>Meeting table W.320 with wooden top (10-12 seats)</i> Table de réunion L.320 avec plan mélaminé (10-12 Places)</p>	SOD730	NCA RM RSB OL GAV GTO BI	AL	320 x 120 x 73	9	0,477	104,1	1.474,00
			BI					NR
 <p><b>Tavolo riunione L.320 piano legno (10-12 posti)</b> <i>Meeting table W.320 with wooden top (10-12 seats)</i> Table de réunion L.320 avec plan mélaminé (10-12 Places)</p>	SOD731	NCA RM RSB OL GAV GTO BI	AL	320 x 120 x 73	9	0,477	104,1	1.615,00
			BI					NR
 <p><b>Tavolo riunione L.360 piano legno (12 posti)</b> <i>Meeting table W.360 with wooden top (12 seats)</i> Table de réunion L.360 avec plan mélaminé (12 Places)</p>	SOD732	NCA RM RSB OL GAV GTO BI	AL	360 x 120 x 73	9	0,499	114,6	1.524,00
			BI					NR
 <p><b>Tavolo riunione L.360 piano legno (12 posti)</b> <i>Meeting table W.360 with wooden top (12 seats)</i> Table de réunion L.360 avec plan mélaminé (12 Places)</p>	SOD733	NCA RM RSB OL GAV GTO BI	AL	360 x 120 x 73	9	0,499	114,6	1.665,00
			BI					NR
 <p><b>Tavolo riunione L.400 piano legno (12-14 posti)</b> <i>Meeting table W.400 with wooden top (12-14 seats)</i> Table de réunion L.400 avec plan mélaminé (12-14 Places)</p>	SOD734	NCA RM RSB OL GAV GTO BI	AL	400 x 120 x 73	9	0,521	124,9	1.574,00
			BI					NR
 <p><b>Tavolo riunione L.400 piano legno (12-14 posti)</b> <i>Meeting table W.400 with wooden top (12-14 seats)</i> Table de réunion L.400 avec plan mélaminé (12-14 Places)</p>	SOD735	NCA RM RSB OL GAV GTO BI	AL	400 x 120 x 73	9	0,521	124,9	1.715,00
			BI					NR





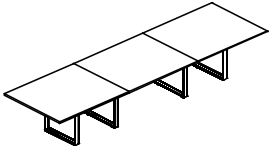
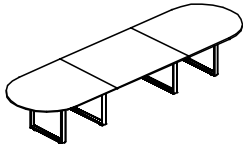
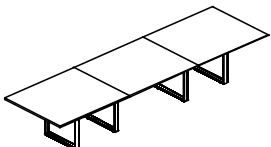
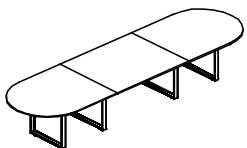
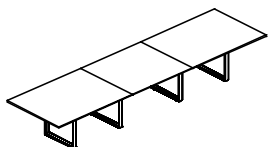
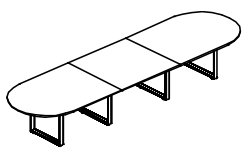

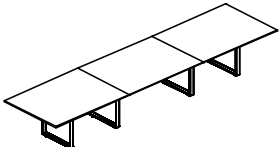
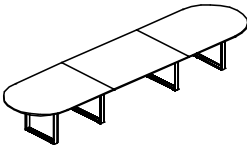

# DIVO

TAVOLI RIUNIONE MEETING TABLES TABLES DE REUNION	CODICE CODE CODE	FINITURA PIANI TOP FINISHING FIN. PLANS	FINITURA GAMBE LEG FINISHING FINITION PIEDS	L x P x H W x D x H L x P x H	COLLI PACKS COLIS	VOLUMI VOLUME VOLUME	PESO WEIGHT POIDS	PREZZO PRICE PRIX
								€
 <p><b>Tavolo riunione L.420 piano legno (14 posti)</b> <i>Meeting table W.420 with wooden top (14 seats)</i> Table de réunion L.420 avec plan mélaminé (14 Places)</p>	<b>SOD736</b>	NCA RM RSB OL GAV GTO BI	AL	420 x 120 x 73	13	0,624	136,8	<b>1.947,00</b>
			CR					<b>2.837,00</b>
 <p><b>Tavolo riunione L.420 piano legno (14 posti)</b> <i>Meeting table W.420 with wooden top (14 seats)</i> Table de réunion L.420 avec plan mélaminé (14 Places)</p>	<b>SOD737</b>	NCA RM RSB OL GAV GTO BI	AL	420 x 120 x 73	13	0,624	136,8	<b>2.088,00</b>
			CR					<b>2.977,00</b>
 <p><b>Tavolo riunione L.440 piano legno (14 posti)</b> <i>Meeting table W.440 with wooden top (14 seats)</i> Table de réunion L.440 avec plan mélaminé (14 Places)</p>	<b>SOD738</b>	NCA RM RSB OL GAV GTO BI	AL	440 x 120 x 73	13	0,635	142,1	<b>1.974,00</b>
			CR					<b>2.869,00</b>
 <p><b>Tavolo riunione L.440 piano legno (14 posti)</b> <i>Meeting table W.440 with wooden top (14 seats)</i> Table de réunion L.440 avec plan mélaminé (14 Places)</p>	<b>SOD739</b>	NCA RM RSB OL GAV GTO BI	AL	440 x 120 x 73	13	0,635	142,1	<b>2.114,00</b>
			CR					<b>3.010,00</b>
 <p><b>Tavolo riunione L.460 piano legno (14-16 posti)</b> <i>Meeting table W.460 with wooden top (14-16 seats)</i> Table de réunion L.460 avec plan mélaminé (14-16 Places)</p>	<b>SOD740</b>	NCA RM RSB OL GAV GTO BI	AL	460 x 120 x 73	13	0,653	147,3	<b>1.998,00</b>
			CR					<b>2.898,00</b>
 <p><b>Tavolo riunione L.460 piano legno (14-16 posti)</b> <i>Meeting table W.460 with wooden top (14-16 seats)</i> Table de réunion L.460 avec plan mélaminé (14-16 Places)</p>	<b>SOD741</b>	NCA RM RSB OL GAV GTO BI	AL	460 x 120 x 73	13	0,653	147,3	<b>2.139,00</b>
			CR					<b>3.039,00</b>



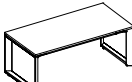

# DIVO

TAVOLI RIUNIONE MEETING TABLES TABLES DE REUNION	CODICE CODE CODE	FINITURA PIANI TOP FINISHING FIN. PLANS	FINITURA GAMBE LEG FINISHING FINITION PIEDS	L x P x H W x D x H L x P x H	COLLI PACKS COLIS	VOLUMI VOLUME VOLUME	PESO WEIGHT POIDS	PREZZO PRICE PRIX
								€
 <p><b>Tavolo riunione L.480 piano legno (16 posti)</b> <i>Meeting table W.480 with wooden top (16 seats)</i> Table de réunion L.480 avec plan mélaminé (16 Places)</p>	SOD742	NCA RM RSB OL GAV GTO BI	AL	480 x 120 x 73	13	0,664	152,6	2.025,00
			CR					2.930,00
 <p><b>Tavolo riunione L.480 piano legno (16 posti)</b> <i>Meeting table W.480 with wooden top (16 seats)</i> Table de réunion L.480 avec plan mélaminé (16 Places)</p>	SOD743	NCA RM RSB OL GAV GTO BI	AL	480 x 120 x 73	13	0,664	152,6	2.166,00
			CR					3.071,00

# DIVO

TAVOLI CAFFÈ COFFEE TABLES TABLES À CAFÉ	CODICE CODE CODE	FINITURA PIANI TOP FINISHING FINITION/PL	FINITURA GAMBE LEG FINISHING FINITION PIEDS	L x P x H W x D x H L x P x H	COLLI PACKS COLIS	VOLUMI VOLUME VOLUME	PESO WEIGHT POIDS	PREZZO PRICE PRIX €
			<b>SOD780</b>	NCA	AL	60 x 60 x 46	3	0,064
<b>Tavolo caffè L.60 piano legno</b> <i>Coffee table W.60 with wooden top</i> Table à café L.60 avec plan mélaminé	RM	BI						
	RSB	NR						
	OL	CR						
	GAV							
GTO								
BI							<b>866,00</b>	
	<b>SOD780V</b>	VS	AL	60 x 60 x 46	3	0,072	24,3	<b>936,00</b>
<b>Tavolo caffè L.60 piano vetro</b> <i>Coffee table W.60 with glass top</i> Table à café L.60 avec plan en verre			BI					
			NR					
		CR						
		VN	AL					
		VB	BI					
		VC	NR					
VR	CR							
							<b>1.143,00</b>	
								<b>1.017,00</b>
								<b>1.224,00</b>
	<b>SOD781</b>	NCA	AL	90 x 60 x 46	3	0,072	23,1	<b>682,00</b>
<b>Tavolo caffè L.90 piano legno</b> <i>Coffee table W.90 with wooden top</i> Table à café L.90 avec plan mélaminé		RM	BI					
		RSB	NR					
		OL	CR					
		GAV						
GTO								
BI							<b>898,00</b>	
	<b>SOD781V</b>	VS	AL	90 x 60 x 46	3	0,085	30,3	<b>1.004,00</b>
<b>Tavolo caffè L.90 piano vetro</b> <i>Coffee table W.90 with glass top</i> Table à café L.90 avec plan en verre			BI					
			NR					
		CR						
		VN	AL					
		VB	BI					
		VC	NR					
VR	CR							
							<b>1.220,00</b>	
								<b>1.116,00</b>
								<b>1.332,00</b>
	<b>SOD782</b>	NCA	AL	120 x 60 x 46	3	0,082	27,0	<b>705,00</b>
<b>Tavolo caffè L.120 piano legno</b> <i>Coffee table W.120 with wooden top</i> Table à café L.120 avec plan mélaminé		RM	BI					
		RSB	NR					
		OL	CR					
		GAV						
GTO								
BI							<b>930,00</b>	
	<b>SOD782V</b>	VS	AL	120 x 60 x 46	3	0,085	30,3	<b>1.071,00</b>
<b>Tavolo caffè L.120 piano vetro</b> <i>Coffee table W.120 with glass top</i> Table à café L.120 avec plan en verre			BI					
			NR					
		CR						
		VN	AL					
		VB	BI					
		VC	NR					
VR	CR							
							<b>1.296,00</b>	
								<b>1.215,00</b>
								<b>1.440,00</b>

# DIVO

TAVOLI CAFFÈ COFFEE TABLES TABLES À CAFÉ	CODICE CODE CODE	FINITURA PIANI TOP FINISHING FIN. PLANS	FINITURA GAMBE LEG FINISHING FINITION PIEDS	L x P x H W x D x H L x P x H	COLLI PACKS COLIS	VOLUMI VOLUME VOLUME	PESO WEIGHT POIDS	PREZZO PRICE PRIX			
								€			
 <p><b>Tavolo caffè circolare piano legno diam.60</b> <i>Round coffee table with wooden top diameter 60</i> Table à café ronde avec plan mélaminé diamètre 60</p>	<b>S0783</b>	NCA	AL	Diam.60 H.52,5	3	0,044	21,3	<b>320,00</b>			
		RM	BI								
		RSB	NR					<b>435,00</b>			
		OL	XL								
		GAV									
		GTO									
		BI									
 <p><b>Tavolo caffè circolare piano vetro diam.60</b> <i>Round coffee table with glass top diameter 60</i> Table à café ronde avec plan en verre diamètre 60</p>	<b>S0783V</b>	VS	AL	Diam.60 H.51,2	3	0,053	24,5	<b>592,00</b>			
			BI								
		NR									
		XL									
		VN	AL								
		VB	BI					<b>660,00</b>			
		VC	NR								
		VR	XL					<b>775,00</b>			
 <p><b>Tavolo caffè 60x60 piano legno</b> <i>Coffee table 60x60 with wooden top</i> Table à café 60x60 avec plan mélaminé</p>	<b>S0783.1</b>	NCA	AL	60 x 60 x 52,5	3	0,052	22,8	<b>324,00</b>			
			RM					BI			
		RSB	NR								
		OL	XL								
		GAV									
		GTO									
		BI						<b>448,00</b>			
 <p><b>Tavolo caffè 60x60 piano vetro</b> <i>Coffee table 60x60 with glass top</i> Table à café 60x60 avec plan en verre</p>	<b>S0783.1V</b>	VS	AL	60 x 60 x 51,2	3	0,061	26,0	<b>596,00</b>			
			BI								
		NR									
		XL									
		VN	AL								
		VB	BI					<b>663,00</b>			
		VC	NR								
		VR	XL					<b>788,00</b>			





# STUDIOFFICE

## DELUXE



### STRUTTURE SCRIVANIE

Il basamento metallico è realizzato con piedi conificati e curvati, dotati di piedini regolabili sulla parte inferiore. Disponibile nelle finiture Cromato o Verniciate con polveri epossidiche nei colori alluminio, nero lucido e bianco. La parte superiore è composta da un solido aggancio mediante travi metalliche che assicura la stabilità dell'intera struttura.

### DESKS STRUCTURES

*Metallic base is made out of conic shaped and curved legs provided with adjustable feet. Basement is available in chromed and epossidic paint aluminium, gloss black, white varnishes. The upper part is characterised by a solid hook through metallic beam which gives stability to the whole structure.*

### STRUCTURES DES BUREAUX

Le piètement métallique est réalisé avec des pieds coniques et courbés, équipé de verins de réglage. Disponible en finition chromée ou laqué aluminium, noir brillant e blanc. Les plans sont liés aux pieds par des poutres métalliques qui donnent stabilité à la structure entière.



01	<b>BI</b> Bianco White Blanc	02	<b>AL</b> Alluminio Aluminium Aluminium	04	<b>NR</b> Nero lucido Gloss black Noir brillant	05	<b>CR</b> Cromato Chrome Chrome
----	---------------------------------------	----	--	----	--	----	--

**\*DELUXE può essere completato con cassettiere, mobili di servizio, contenitori ed accessori consultabili nelle rispettive sezioni da pag. 141 a seguire.**

*\*DELUXE can be completed with drawers, service cabinets, cabinets and accessories to be found in the respective sections from page 141 on*

*\*DELUXE peut être complété avec caissons mobiles, des meubles de service, des armoires et accessoires disponibles dans les sections correspondantes à partir de la page 141 à suivre*

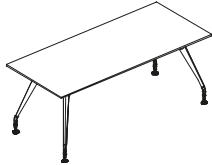
# DELUXE

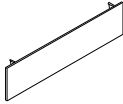
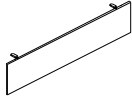
SCRIVANIE DIREZIONALI P.90 EXECUTIVE DESKS P.90 BUREAUX DIRECTION P.90	CODICE CODE CODE	FINITURA PIANI TOP FINISHING FIN. PLANS	FINITURA GAMBE LEG FINISHING FINITION PIEDS	L x P x H W x D x H L x P x H	COLLI PACKS COLIS	VOLUMI VOLUME VOLUME	PESO WEIGHT POIDS	PREZZO PRICE PRIX	
								€	
 <p><b>Scrivania piano legno</b> <i>Desk with wooden top</i> Poste avec plan mélaminé</p>	SOX370	NCA RM RSB OL GAV GTO BI	AL BI NR	180 x 90 x 73	7	0,159	48,4	727,00	
			CR					876,00	
	SOX371		AL BI NR	200 x 90 x 73	7	0,169	52,6	749,00	
			CR					898,00	
	SOX372		AL BI NR	220 x 90 x 73	7	0,178	56,7	769,00	
			CR					917,00	
	 <p><b>Scrivania piano vetro</b> <i>Desk with glass top</i> Poste avec plan en verre</p>	SOX370V	VS	AL BI NR	180 x 90 x 73	7	0,192	69,4	1.450,00
				CR					1.599,00
			VN VB VC VR	AL BI NR					1.712,00
CR				1.861,00					
SOX371V		VS	AL BI NR	200 x 90 x 73	7	0,204	76,0	1.503,00	
			CR					1.652,00	
		VN VB VC VR	AL BI NR					1.812,00	
			CR					1.961,00	
SOX372V		VS	AL BI NR	220 x 90 x 73	7	0,216	82,5	1.575,00	
	CR		1.724,00						
	VN VB VC VR	AL BI NR	1.888,00						
		CR	2.037,00						
 <p><b>Modesty panel per scrivanie legno</b> <i>Modesty panel for wooden desks</i> Voile de fond pour plan mélaminé</p>	SO603	NCA RM	Per SOX370 For SOX370 POUR SOX370	L.128 x H.28,4	2	0,016	5,9	56,00	
	SO604	RSB OL GAV	Per SOX371 For SOX371 POUR SOX371	L.148 x H.28,4	2	0,018	6,7	60,00	
	SO605	GTO BI	Per SOX372 For SOX372 POUR SOX372	L.168 x H.28,4	2	0,020	7,5	63,00	
 <p><b>Modesty panel per scrivanie vetro</b> <i>Modesty panel for glass desks</i> Voile de fond pour plan en verre</p>	SO603V	NCA RM	Per SOX370V For SOX370V POUR SOX370V	L.128 x H.28,4	1	0,016	5,9	56,00	
	SO604V	RSB OL GAV	Per SOX371V For SOX371V POUR SOX371V	L.148 x H.28,4	1	0,018	6,7	60,00	
	SO605V	GTO BI	Per SOX372V For SOX372V POUR SOX372V	L.168 x H.28,4	1	0,020	7,5	63,00	



# DELUXE

Da completare sempre con allunghi (PAG.26-27)

To be completed always with extension (PAGE 26-27)

A compléter toujours avec rallonge (PAGE 26-27)

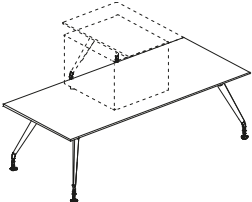
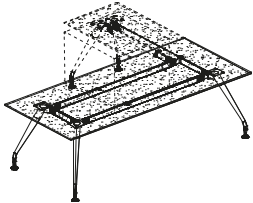
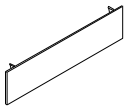
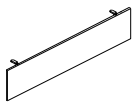
SCRIVANIE DIREZIONALI P.90 PER ALLUNGO EXECUTIVE DESKS P.90 FOR EXTENSION BUREAUX DIRECTION P.90 POUR EXTENSION	CODICE CODE CODE	FINITURA PIANI TOP FINISHING FIN. PLANS	FINITURA GAMBE LEG FINISHING FINITION PIEDS	L x P x H W x D x H L x P x H	COLLI PACKS COLIS	VOLUMI VOLUME VOLUME	PESO WEIGHT POIDS	PREZZO PRICE PRIX €
 <p><b>SX</b></p> <p>Scrivania piano legno per allungo legno Desk with wooden top for wooden extension Poste plan mélaminé pour extension mélaminé</p>	SOX370A DX-SX	NCA	AL	180 x 90 x 73	5	0,119	46,3	574,00
			BI					684,00
			NR					
	SOX371A DX-SX	RMB	AL	200 x 90 x 73	5	0,129	50,5	596,00
			BI					706,00
			NR					
	SOX372A DX-SX	GAV	AL	220 x 90 x 73	5	0,138	54,6	615,00
			BI					726,00
			NR					
 <p><b>SX</b></p> <p>Scrivania piano vetro per allungo vetro Desk with glass top and glass extension Poste plan en verre + extension en verre</p>	SOX370AV DX-SX	VS	AL	180 x 90 x 73	5	0,151	67,3	1.297,00
			BI					1.407,00
			NR					1.559,00
			CR					1.669,00
	SOX371AV DX-SX	VN	AL	200 x 90 x 73	5	0,164	73,9	1.349,00
			BI					1.460,00
			NR					1.659,00
			CR					1.769,00
	SOX372AV DX-SX	VR	AL	220 x 90 x 73	5	0,176	80,4	1.422,00
			BI					1.533,00
			NR					1.735,00
			CR					1.845,00
 <p>Modesty panel per scrivanie legno Modesty panel for wooden desks Voile de fond pour plan mélaminé</p>	S0603	NCA	Per SOX370A For SOX370A POUR SOX370A	L.128 x H.28,4	2	0,016	5,9	56,00
	S0604	RSB	Per SOX371A For SOX371A POUR SOX371A	L.148 x H.28,4	2	0,018	6,7	60,00
	S0605	GAV	Per SOX372A For SOX372A POUR SOX372A	L.168 x H.28,4	2	0,020	7,5	63,00
 <p>Modesty panel per scrivanie vetro Modesty panel for glass desks Voile de fond pour plan en verre</p>	S0603V	NCA	Per SOX370AV For SOX370AV POUR SOX370AV	L.128 x H.28,4	1	0,016	5,9	56,00
	S0604V	RSB	Per SOX371AV For SOX371AV POUR SOX371AV	L.148 x H.28,4	1	0,018	6,7	60,00
	S0605V	GAV	Per SOX372AV For SOX372AV POUR SOX372AV	L.168 x H.28,4	1	0,020	7,5	63,00

# DELUXE

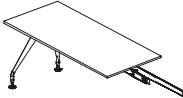
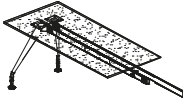
ALLUNGHI LATERALI LATERAL EXTENSION EXTENSION LATERALES		CODICE CODE CODE	FINITURA PIANI TOP FINISHING FIN. PLANS	FINITURA GAMBE LEG FINISHING FINITION PIEDS	L x P x H W x D x H L x P x H	COLLI PACKS COLIS	VOLUMI VOLUME VOLUME	PESO WEIGHT POIDS	PREZZO PRICE PRIX €
 <p><b>SX</b></p> <p><b>Allungo laterale per piani legno</b> <i>Lateral extension for wooden desks</i> Extension laterale pour poste mélaminé</p>	SOX312A DX-SX	NCA RM RSB	AL BI NR	90 x 60 x 73	5	0,069	20,3	360,00	
			CR					435,00	
	SOX313A DX-SX	NCA RM RSB	AL BI NR	100 x 60 x 73	5	0,072	21,4	365,00	
			CR					440,00	
	SOX314A DX-SX	OL GAV GTO BI	AL BI NR	120 x 60 x 73	5	0,078	24,5	382,00	
			CR					456,00	
	SOX315A DX-SX	OL GAV GTO BI	AL BI NR	140 x 60 x 73	5	0,085	27,4	397,00	
			CR					471,00	
	 <p><b>SX</b></p> <p><b>Allungo laterale per piani vetro</b> <i>Lateral extension for glass desks</i> Extension laterale pour poste en verre</p>	SOX312AV DX-SX	VS	AL BI NR	90 x 60 x 73	5	0,082	27,3	624,00
				CR					698,00
VN VB VC VR				AL BI NR					736,00
CR				811,00					
SOX313AV DX-SX		VS	VN VB VC VR	AL BI NR	100 x 60 x 73	5	0,086	29,2	646,00
				CR					721,00
				AL BI NR					781,00
				CR					856,00
SOX314AV DX-SX		VS	VN VB VC VR	AL BI NR	120 x 60 x 73	5	0,094	33,8	689,00
				CR					764,00
				AL BI NR					833,00
				CR					908,00
SOX315AV DX-SX		VS	VN VB VC VR	AL BI NR	140 x 60 x 73	5	0,103	38,3	740,00
				CR					814,00
				AL BI NR					929,00
				CR					1.003,00

# DELUXE

Da completare sempre con mobili di servizio portanti L.64,5-80-120-135 (PAG.168)

To be completed always with load bearing service cabinet W.64,5-80-120-135 (PAGE.168)

A compléter toujours avec meubles porteur L.64,5-80-120-135 (PAGE.168)

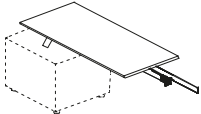
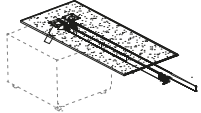
ALLUNGHI LATERALI PORTANTI LOAD BEARING LATERAL EXTENSION EXTENSIONS LATÉRALES PORTEURS		CODICE CODE CODE	FINITURA PIANI TOP FINISHING FIN. PLANS	FINITURA GAMBE LEG FINISHING FINITION PIEDS	L x P x H W x D x H L x P x H	COLLI PACKS COLIS	VOLUMI VOLUME VOLUME	PESO WEIGHT POIDS	PREZZO PRICE PRIX €	
 <p><b>Allungo laterale portante per piani legno</b> Load bearing lateral extension for wooden desks Extension laterale porteur pour poste mélaminé</p>	SX	SOX312P DX-SX		AL	90 x 60 x 73	5	0,037	17,1	313,00	
				BI					347,00	
				NR						
				CR						
					AL	100 x 60 x 73	5	0,040	18,2	318,00
				BI	352,00					
				NR						
				CR						
					AL	120 x 60 x 73	5	0,046	21,3	334,00
				BI	368,00					
				NR						
				CR						
				AL	140 x 60 x 73	5	0,052	24,2	349,00	
			BI	383,00						
			NR							
			CR							
 <p><b>Allungo laterale portante per piani vetro</b> Load bearing lateral extension for glass desks Extension laterale porteur pour poste en verre</p>	SX	SOX312PV DX-SX	VS	AL	90 x 60 x 73	5	0,049	24,1	577,00	
				BI					610,00	
				NR					689,00	
				CR					723,00	
				VN						
				VB						
				VC						
				VR						
					AL	100 x 60 x 73	5	0,053	26,0	599,00
				BI	633,00					
				NR	734,00					
				CR	768,00					
					AL	120 x 60 x 73	5	0,062	30,6	642,00
				BI	676,00					
				NR	786,00					
				CR	820,00					
					AL	140 x 60 x 73	5	0,071	35,1	693,00
			BI	726,00						
			NR	882,00						
			CR	915,00						

# DELUXE

Da completare sempre con mobili di servizio portanti L.64,5-80-120-135-160-180 (PAG.168)

To be completed always with load bearing service cabinet W.64,5-80-120-135-160-180 (PAGE.168)

A compléter toujours avec meubles porteur L.64,5-80-120-135-160-180 (PAGE.168)

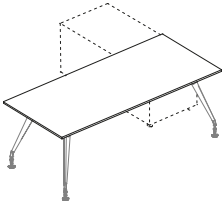
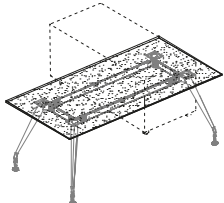
SCRIVANIE DIREZIONALI PORTANTI P.90 LOAD BEARING EXECUTIVE DESKS D.90 BUREAUX DIRECTION PORTEURS P.90	CODICE CODE CODE	FINITURA PIANI TOP FINISHING FIN. PLANS	FINITURA GAMBE LEG FINISHING FINITION PIEDS	L x P x H W x D x H L x P x H	COLLI PACKS COLIS	VOLUMI VOLUME VOLUME	PESO WEIGHT POIDS	PREZZO PRICE PRIX						
								€						
 <p><b>Scrivania piano legno</b> <i>Desk with wooden top</i> Poste avec plan mélaminé</p>	SOX370P	NCA	AL	180 x 90 x 73	7	0,159	46,7	703,00						
			BI					848,00						
			NR											
	SOX371P	RM	AL	200 x 90 x 73	7	0,169	50,9	725,00						
			BI					870,00						
			NR											
	SOX372P	RSB	AL	220 x 90 x 73	7	0,178	55,0	745,00						
			BI					889,00						
			NR											
 <p><b>Scrivania piano vetro</b> <i>Desk with glass top</i> Poste avec plan en verre</p>	SOX370PV	VS	AL	180 x 90 x 73	7	0,191	72,3	1.426,00						
			BI					1.571,00						
			NR					1.688,00						
			CR					1.833,00						
	SOX371PV	VN	VB	AL	200 x 90 x 73	7	0,204	78,9	1.479,00					
				BI					1.624,00					
				NR					1.789,00					
				CR					1.933,00					
	SOX372PV	VC	VR	AL	220 x 90 x 73	7	0,216	85,4	1.552,00					
				BI					1.696,00					
NR				1.864,00										
CR				2.009,00										
SO603	NCA	RM	Per SOX370P For SOX370P POUR SOX370P	L.128 x H.28,4	2	0,016	5,9	56,00						
			SO604					RSB	Per SOX371P For SOX371P POUR SOX371P	L.148 x H.28,4	2	0,018	6,7	60,00
			SO605						GTO					Per SOX372P For SOX372P POUR SOX372P
SO603V	NCA	RM	Per SOX370PV For SOX370PV POUR SOX370PV	L.128 x H.28,4	1	0,016	5,9	56,00						
			SO604V					RSB	Per SOX371PV For SOX371PV POUR SOX371PV	L.148 x H.28,4	1	0,018	6,7	60,00
			SO605V						GTO					Per SOX372PV For SOX372PV POUR SOX372PV
			BI											

# DELUXE

Da completare sempre con mobili di servizio portanti L.160-180 (PAG.169)

To be completed always with load bearing service cabinet L.160-180 (PAGE.169)

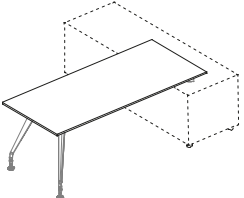
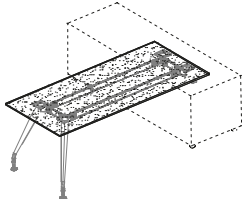
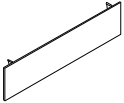
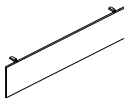

A compléter toujours avec meubles porteur L.160-180 (PAGE.169)

SCRIVANIE DIREZIONALI PORTANTI P.90 LOAD BEARING EXECUTIVE DESKS D.90 BUREAUX DIRECTION PORTEURS P.90	CODICE CODE CODE	FINITURA PIANI TOP FINISHING FIN. PLANS	FINITURA GAMBE LEG FINISHING FINITION PIEDS	L x P x H W x D x H L x P x H	COLLI PACKS COLIS	VOLUMI VOLUME VOLUME	PESO WEIGHT POIDS	PREZZO PRICE PRIX €	
 <p><b>Scrivania piano legno</b> <i>Desk with wooden top</i> Poste avec plan mélaminé</p>	SOX370PD	NCA	AL	180 x 90 x 73	7	0,127	45,2	680,00	
			BI					788,00	
	SOX371PD	RMB	AL	200 x 90 x 73	7	0,137	49,4	702,00	
			BI					810,00	
	SOX372PD	GTO	AL	220 x 90 x 73	7	0,146	53,5	721,00	
			BI					830,00	
	<p><b>SX</b></p>  <p><b>Scrivania piano vetro</b> <i>Desk with glass top</i> Poste avec plan en verre</p>	SOX370PDV DX-SX	VS	AL	180 x 90 x 73	7	0,159	66,2	1.403,00
				BI					1.511,00
				NR					1.665,00
CR				1.773,00					
SOX372PDV DX-SX		VS	VN	AL	200 x 90 x 73	7	0,172	72,8	1.456,00
				BI					1.564,00
				NR					1.765,00
				CR					1.873,00
SOX372PDV DX-SX		VS	VN	AL	220 x 90 x 73	7	0,184	79,3	1.528,00
				BI					1.636,00
				NR					1.841,00
				CR					1.949,00
 <p><b>Modesty panel per scrivanie legno</b> <i>Modesty panel for wooden desks</i> Voile de fond pour plan mélaminé</p>	S0602	NCA	Per SOX370PD For SOX370PD POUR SOX370PD	L.108 x H.28,4	2	0,014	5,1	53,00	
	S0603	RSB	Per SOX371PD For SOX371PD POUR SOX371PD	L.128 x H.28,4	2	0,016	5,9	56,00	
	S0604	GTO	Per SOX372PD For SOX372PD POUR SOX372PD	L.148 x H.28,4	2	0,018	6,7	60,00	
 <p><b>Modesty panel per scrivanie vetro</b> <i>Modesty panel for glass desks</i> Voile de fond pour plan en verre</p>	S0602V	NCA	Per SOX370PDV For SOX370PDV POUR SOX370PDV	L.108 x H.28,4	2	0,014	5,1	53,00	
	S0603V	RSB	Per SOX371PDV For SOX371PDV POUR SOX371PDV	L.128 x H.28,4	2	0,016	5,9	56,00	
	S0604V	GTO	Per SOX372PDV For SOX372PDV POUR SOX372PDV	L.148 x H.28,4	2	0,018	6,7	60,00	

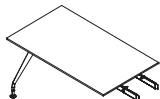
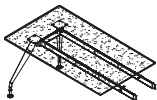
# DELUXE

ALLUNGHI FRONTALI FRONTAL EXTENSION EXTENSIONS FRONTALE	CODICE CODE CODE	FINITURA PIANI TOP FINISHING FIN. PLANS	FINITURA GAMBE LEG FINISHING FINITION PIEDS	L x P x H W x D x H L x P x H	COLLI PACKS COLIS	VOLUMI VOLUME VOLUME	PESO WEIGHT POIDS	PREZZO PRICE PRIX		
								€		
 <p><b>Allungo frontale per piani legno</b> <i>Frontal extension for wooden desks</i> Extension frontale pour poste mélaminé</p>	SOX348F	NCA RM RSB OL GAV GTO BI	AL BI NR	120 x 80 x 73	7	0,090	29,3	425,00		
			CR					499,00		
	SOX349F		AL BI NR	140 x 80 x 73	7	0,097	32,9	443,00		
			CR					518,00		
	SOX350F		AL BI NR	160 x 80 x 73	7	0,106	36,8	464,00		
			CR					538,00		
	 <p><b>Allungo frontale per piani vetro</b> <i>Frontal extension for glass desks</i> Extension frontale pour poste en verre</p>		SOX348FV	VS	AL BI NR	120 x 80 x 73	7	0,110	41,8	813,00
					CR					887,00
					VN VB VC VR					AL
BI		1.015,00								
NR		1.015,00								
CR		1.089,00								
SOX349FV		VS	AL BI NR	140 x 80 x 73	7	0,121	47,5	864,00		
			CR					938,00		
			VN VB VC VR					AL	1.089,00	
								BI	1.089,00	
								NR	1.089,00	
CR		1.163,00								
SOX350FV		VS	AL BI NR	160 x 80 x 73	7	0,132	53,4	916,00		
			CR					991,00		
			VN VB VC VR					AL	1.186,00	
	BI							1.186,00		
	NR							1.186,00		
CR	1.261,00									

# DELUXE

TAVOLI DATILO TYPING DESKS TABLES DACTYLO	CODICE CODE CODE	FINITURA PIANI TOP FINISHING FIN. PLANS	FINITURA GAMBE LEG FINISHING FINITION PIEDS	L x P x H W x D x H L x P x H	COLLI PACKS COLIS	VOLUMI VOLUME VOLUME	PESO WEIGHT POIDS	PREZZO PRICE PRIX		
								€		
 <p><b>Tavolo dattilo piano legno</b> <i>Wooden typing desk</i> Table dactylo mélaminé</p>	SOX312D	NCA RM RSB OL GAV GTO BI	AL BI NR	90 x 60 x 73	5	0,106	23,7	584,00		
			CR					732,00		
	SOX313D		AL BI NR	100 x 60 x 73	5	0,109	25,0	589,00		
			CR					738,00		
	SOX314D		AL BI NR	120 x 60 x 73	5	0,115	28,1	601,00		
			CR					750,00		
	SOX315D		AL BI NR	140 x 60 x 73	5	0,121	31,1	617,00		
			CR					766,00		
	 <p><b>Tavolo dattilo piano vetro</b> <i>Glass typing desk</i> Table dactylo en verre</p>		SOX312DV	VS	AL BI NR	90 x 60 x 73	5	0,118	30,7	906,00
					CR					1.054,00
VN VB VC VR		AL BI NR		1.018,00						
		CR		1.167,00						
SOX313DV		VS	AL BI NR	100 x 60 x 73	5	0,122	32,6	929,00		
			CR					1.078,00		
		VN VB VC VR	AL BI NR					1.064,00		
			CR					1.213,00		
SOX314DV		VS	AL BI NR	120 x 60 x 73	5	0,131	37,4	967,00		
			CR					1.116,00		
		VN VB VC VR	AL BI NR					1.111,00		
			CR					1.260,00		
SOX315DV		VS	AL BI NR	140 x 60 x 73	5	0,132	38,1	1.019,00		
			CR					1.168,00		
		VN VB VC VR	AL BI NR					1.208,00		
			CR					1.357,00		

# DELUXE

Da completare sempre con mobili di servizio portanti L.64,5-80-120-135-160-180 (PAG.168)

To be completed always with load bearing service cabinet L.64,5-80-120-135-160-180 (PAGE.168)

A compléter toujours avec meubles porteur L.64,5-80-120-135-160-180 (PAGE.168)

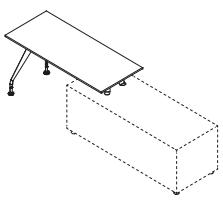
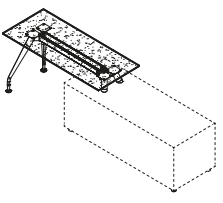
TAVOLI DATILO PORTANTI LOAD BEARING TYPING DESKS TABLES DACTYLO PORTEURS	CODICE CODE CODE	FINITURA PIANI TOP FINISHING FIN. PLANS	FINITURA GAMBE LEG FINISHING FINITION PIEDS	L x P x H W x D x H L x P x H	COLLI PACKS COLIS	VOLUMI VOLUME VOLUME	PESO WEIGHT POIDS	PREZZO PRICE PRIX	
								€	
 <p><b>Tavolo dattilo portante piano legno</b> <i>Load bearing wooden typing desk</i> Table dactylo porteur mélaminé</p>	SOX312DP		AL	90 x 60 x 73	5	0,073	20,5	536,00	
			BI					645,00	
		CR							
	SOX313DP	NCA	RM	AL	100 x 60 x 73	5	0,076	21,8	542,00
				BI					650,00
		RSB		CR					
	SOX314DP	OL	GAV	AL	120 x 60 x 73	5	0,083	24,9	554,00
				BI					662,00
	GTO	BI	CR						
									NR
SOX315DP			AL	140 x 60 x 73	5	0,089	27,9	570,00	
			BI					678,00	
			CR						
									NR
 <p><b>Tavolo dattilo portante piano vetro</b> <i>Load bearing glass typing desk</i> Table dactylo porteur en verre</p>	SOX312DPV	VS	AL	90 x 60 x 73	5	0,086	27,5	858,00	
			BI					966,00	
			NR					971,00	
			CR					1.079,00	
	SOX313DPV	VS	VN	AL	100 x 60 x 73	5	0,090	29,4	882,00
				BI					990,00
				NR					1.017,00
				CR					1.125,00
	SOX314DPV	VS	VN	AL	120 x 60 x 73	5	0,099	34,2	920,00
				BI					1.028,00
				NR					1.064,00
				CR					1.172,00
	SOX315DPV	VS	VN	AL	140 x 60 x 73	5	0,107	38,8	972,00
				BI					1.080,00
				NR					1.161,00
				CR					1.269,00



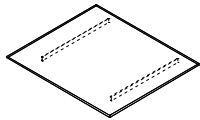
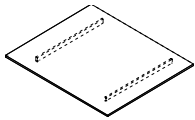
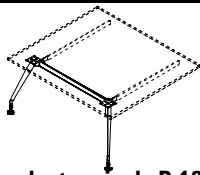
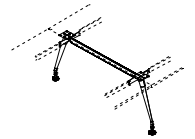
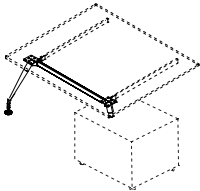

# DELUXE

ELEMENTI PER POSTAZIONI BENCH E TAVOLI RIUNIONE P.160 ITEMS FOR BENCH SYSTEM AND MEETING TABLE D.160 ELEMENT POUR SYSTÈME BENCH ET TABLES DE REUNION P.160	CODICE CODE CODE	FINITURA PIANI TOP FINISHING FIN. PLANS	FINITURA GAMBE LEG FINISHING FINITION PIEDS	L x P x SP. W x D x TH L x P x E.	COLLI PACKS COLIS	VOLUMI VOLUME VOLUME	PESO WEIGHT POIDS	PREZZO PRICE PRIX €
 <p><b>Piano terminale con travi P.160</b> <i>Terminal desktop with cross-beam D.160</i> Plan terminal avec poutres P.160</p>	SOX730T	NCA RM RSB OL GAV GTO BI		120 x 160 x 2,5	3	0,092	39,4	198,00
	SOX731T			140 x 160 x 2,5	3	0,107	46,2	230,00
	SOX732T			160 x 160 x 2,5	3	0,123	52,8	261,00
 <p><b>Piano intermedio con travi P.160</b> <i>Intermediate desktop with cross-beam D.160</i> Plan intermédiaire avec poutres P.160</p>	SOX730C	NCA RM RSB OL GAV GTO BI		120 x 160 x 2,5	3	0,093	40,1	204,00
	SOX731C			140 x 160 x 2,5	3	0,108	46,8	236,00
	SOX732C			160 x 160 x 2,5	3	0,123	53,6	269,00
 <p><b>Gamba terminale P.160</b> <i>Terminal leg D. 160</i> Pied terminal P.160</p>	SOX735T		AL BI NR	P.160 x H.70,5	2	0,041	7,9	279,00
		CR	353,00					
 <p><b>Gamba centrale P.160</b> <i>Central leg D.160</i> Pied central P.160</p>	SOX735C		AL BI NR	P.160 x H.70,5	2	0,041	8,7	315,00
		CR	394,00					
 <p><b>Gamba terminale mozza P.160</b> <i>Cut terminal leg D 160</i> Pied terminal coupé P.160</p>	SOX736T		AL BI NR	P.160 x H.70,5	2	0,041	6,2	255,00
		CR	325,00					

# DELUXE

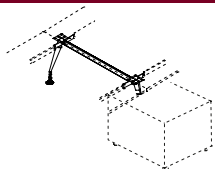
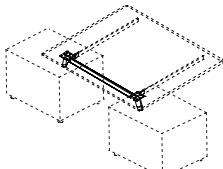
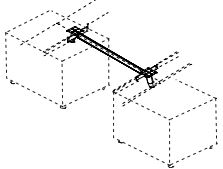
ELEMENTI PER POSTAZIONI BENCH E TAVOLI RIUNIONE P.160 ITEMS FOR BENCH SYSTEM AND MEETING TABLE D.160 ELEMENT POUR SYSTÈME BENCH ET TABLES DE REUNION P.160	CODICE CODE CODE	FINITURA PIANI TOP FINISHING FIN. PLANS	FINITURA GAMBE LEG FINISHING FINITION PIEDS	L x P x H W x D x H L x P x H	COLLI PACKS COLIS	VOLUMI VOLUME VOLUME	PESO WEIGHT POIDS	PREZZO PRICE PRIX €
 <p><b>Gamba centrale mozza P.160</b> <i>Central cut leg D.160</i> Pied central coupé P.160</p>	SOX736C		AL	P.160 x H.70,5	2	0,041	6,8	291,00
			BI					366,00
 <p><b>Gamba terminale doppia mozza P.160</b> <i>Double cut terminal leg D.160</i> Pied terminal double coupé P.160</p>	SOX737T		NR	P.160 x H.70,5	2	0,009	4,7	231,00
			CR					265,00
 <p><b>Gamba centrale doppia mozza P.160</b> <i>Double cut central leg D.160</i> Pied central double coupé P.160</p>	SOX737C		AL	P.160 x H.70,5	2	0,009	4,7	267,00
			BI					301,00
NR			CR					

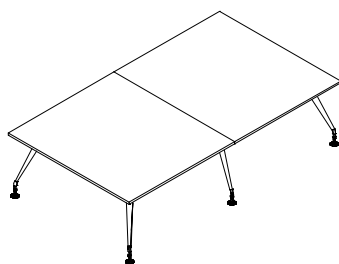
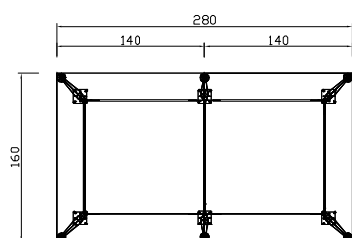

# DELUXE

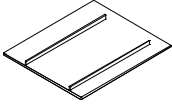
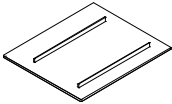
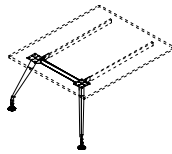
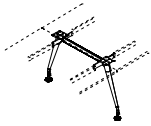
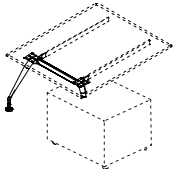
ELEMENTI PER POSTAZIONI BENCH E TAVOLI RIUNIONE P.120 ITEMS FOR BENCH SYSTEM AND MEETING TABLE D.120 ELEMENT POUR SYSTÈME BENCH ET TABLES DE REUNION P.120	CODICE CODE CODE	FINITURA PIANI TOP FINISHING FIN. PLANS	FINITURA GAMBE LEG FINISHING FINITION PIEDS	L x P x SP. W x D x TH L x P x E.	COLLI PACKS COLIS	VOLUMI VOLUME VOLUME	PESO WEIGHT POIDS	PREZZO PRICE PRIX €
 <p><b>Piano terminale con travi P.120</b> <i>Terminal desktop with cross-beam D.120</i> Plan terminal avec poutres P.120</p>	SOX740T	NCA RM RSB OL GAV GTO BI		120 x 120 x 2,5	3	0,070	30,3	161,00
	SOX741T			140 x 120 x 2,5	3	0,082	35,5	185,00
	SOX742T			160 x 120 x 2,5	3	0,093	40,7	210,00
 <p><b>Piano intermedio con travi P.120</b> <i>Intermediate desktop with cross-beam D.120</i> Plan intermédiaire avec poutres P.120</p>	SOX740C	NCA RM RSB OL GAV GTO BI		120 x 120 x 2,5	3	0,071	31,0	167,00
	SOX741C			140 x 120 x 2,5	3	0,082	36,1	191,00
	SOX742C			160 x 120 x 2,5	3	0,094	41,5	218,00
 <p><b>Gamba terminale P.120</b> <i>Terminal leg D.120</i> Pied terminal P.120</p>	SOX745T		AL BI NR	P.120 x H.70,5	2	0,041	7,2	272,00
			CR					347,00
 <p><b>Gamba centrale P.120</b> <i>Central leg D.120</i> Pied central P.120</p>	SOX745C		AL BI NR	P.120 x H.70,5	2	0,041	8,0	308,00
			CR					387,00
 <p><b>Gamba terminale mozza P.120</b> <i>Cut terminal leg D.120</i> Pied terminal coupé P.120</p>	SOX746T		AL BI NR	P.120 x H.70,5	2	0,041	5,5	248,00
			CR					319,00

# DELUXE

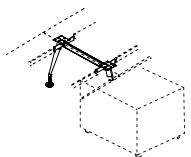
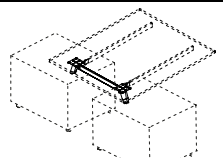
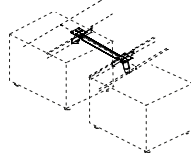
ELEMENTI PER POSTAZIONI BENCH E TAVOLI RIUNIONE P.120 ITEMS FOR BENCH SYSTEM AND MEETING TABLE D.120 ELEMENT POUR SYSTÈME BENCH ET TABLES DE REUNION P.120	CODICE CODE CODE	FINITURA PIANI TOP FINISHING FIN. PLANS	FINITURA GAMBE LEG FINISHING FINITION PIEDS	L x P x H W x D x H L x P x H	COLLI PACKS COLIS	VOLUMI VOLUME VOLUME	PESO WEIGHT POIDS	PREZZO PRICE PRIX
								€
 <p><b>Gamba centrale mozza P.120</b> <i>Central cut leg D.120</i> Pied central coupé P.120</p>	SOX746C		AL	P.120 x H.70,5	2	0,041	5,5	284,00
			BI					359,00
 <p><b>Gamba terminale doppia mozza P.120</b> <i>Double cut terminal leg D.120</i> Pied terminal double coupé P.120</p>	SOX747T		NR	P.120 x H.70,5	2	0,008	4,0	225,00
			CR					259,00
 <p><b>Gamba centrale doppia mozza P.120</b> <i>Double cut central leg D.120</i> Pied central double coupé P.120</p>	SOX747C		AL	P.120 x H.70,5	2	0,008	4,0	261,00
			BI					295,00
			NR					
			CR					



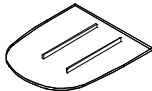
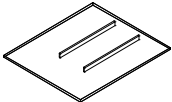
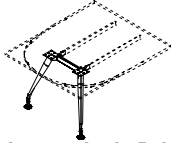
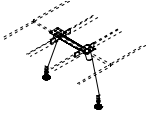



# DELUXE

ELEMENTI PER TAVOLI RIUNIONE COMPONIBILI P.120 ITEMS FOR MODULAR MEETING TABLE P.120 ELEMENT POUR TABLES DE REUNION MODULAIRES P.120	CODICE CODE CODE	FINITURA PIANI TOP FINISHING FIN. PLANS	FINITURA GAMBE LEG FINISHING FINITION PIEDS	L x P x SP. W x D x TH L x P x E.	COLLI PACKS COLIS	VOLUMI VOLUME VOLUME	PESO WEIGHT POIDS	PREZZO PRICE PRIX
								€
 <p><b>Piano terminale con travi P.120</b> <i>Terminal desktop with cross-beam D.120</i> Plan terminal avec poutres P.120</p>	SOX750T	NCA RM RSB OL GAV GTO BI		120 x 120 x 2,5	3	0,070	30,3	231,00
	SOX751T			140 x 120 x 2,5	3	0,082	35,5	256,00
	SOX752T			160 x 120 x 2,5	3	0,093	40,7	281,00
 <p><b>Piano intermedio con travi P.120</b> <i>Intermediate desktop with cross-beam D.120</i> Plan intermédiaire avec poutres P.120</p>	SOX750C	NCA RM RSB OL GAV GTO BI		120 x 120 x 2,5	3	0,071	31,0	167,00
	SOX751C			140 x 120 x 2,5	3	0,082	36,1	191,00
	SOX752C			160 x 120 x 2,5	3	0,094	41,5	218,00
 <p><b>Gamba terminale P.120</b> <i>Terminal leg D.120</i> Pied terminal P.120</p>	SOX755T		AL BI NR	P.120 x H.70,5	2	0,040	6,7	271,00
			CR					345,00
 <p><b>Gamba terminale P.120</b> <i>Terminal leg D.120</i> Pied terminal P.120</p>	SOX755C		AL BI NR	P.120 x H.70,5	2	0,040	7,5	307,00
			CR					386,00

**DELUXE**





**COMPOSIZIONI**

# DELUXE

TAVOLI RIUNIONE MEETING TABLES TABLES DE REUNION	CODICE CODE CODE	FINITURA PIANI TOP FINISHING FIN. PLANS	FINITURA GAMBE LEG FINISHING FINITION PIEDS	L x P x H W x D x H L x P x H	COLLI PACKS COLIS	VOLUMI VOLUME VOLUME	PESO WEIGHT POIDS	PREZZO PRICE PRIX	
								€	
 <b>Tavolo circolare diam.90 piano legno (4 posti)</b> <i>Round meeting table D.90 with wooden top (4 seats)</i> Table de réunion ronde D.90 avec plan mélaminé (4 Places)	S0721	NCA RM RSB OL GAV GTO BI	AL	Diam.90 H.75,5	3	0,081	31,4	347,00	
			BI					NR	472,00
 <b>Tavolo circolare diam.90 piano vetro (4 posti)</b> <i>Round meeting table D.90 with glass top (4 seats)</i> Table de réunion ronde D.90 avec plan en verre (4 Places)	S0721V	VS VN VB VC VR	AL	Diam.90 H.74,2	3	0,098	39,7	741,00	
			BI					NR	866,00
			XL					AL	899,00
			BI					NR	1.024,00
			VR					XL	1.024,00
 <b>Tavolo riunione 90x90 piano legno (4 posti)</b> <i>Meeting table 90x90 with wooden top (4 seats)</i> Table de réunion 90x90 avec plan mélaminé (4 Places)	S0721.1	NCA RM RSB OL GAV GTO BI	AL	90 x 90 x 75,5	3	0,075	33,4	374,00	
			BI					NR	511,00
 <b>Tavolo riunione 90x90 piano vetro (4 posti)</b> <i>Meeting table 90x90 with glass top (4 seats)</i> Table de réunion 90x90 avec plan en verre (4 Places)	S0721.V	VS VN VB VC VR	AL	90 x 90 x 74,2	3	0,092	41,7	768,00	
			BI					NR	905,00
			XL					AL	926,00
			BI					NR	1.062,00
			VR					XL	1.062,00
 <b>Tavolo circolare diam.90 piano legno (4 posti)</b> <i>Round meeting table D.90 with wooden top (4 seats)</i> Table de réunion ronde D.90 avec plan mélaminé (4 Places)	SOX721	NCA RM RSB OL GAV GTO BI	AL	Diam.90 H.73	3	0,117	27,6	683,00	
			BI					NR	844,00
 <b>Tavolo circolare diam.90 piano vetro (4 posti)</b> <i>Round meeting table D.90 with glass top (4 seats)</i> Table de réunion ronde D.90 avec plan en verre (4 Places)	SOX721V	VS VN VB VC VR	AL	Diam.90 H.73	3	0,134	35,9	1.109,00	
			BI					NR	1.269,00
			CR					AL	1.279,00
			BI					NR	1.279,00
			VR					CR	1.439,00

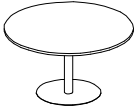

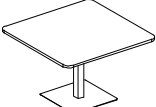
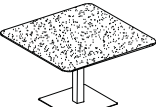
# DELUXE

TAVOLI RIUNIONE MEETING TABLES TABLES DE REUNION	CODICE CODE CODE	FINITURA PIAMI TOP FINISHING FIN. PLANS	FINITURA GAMBE LEG FINISHING FINITION PIEDS	L x P x H W x D x H L x P x H	COLLI PACKS COLIS	VOLUMI VOLUME VOLUME	PESO WEIGHT POIDS	PREZZO PRICE PRIX
								€
 <p><b>Tavolo circolare diam.120 piano legno (4 posti)</b> <i>Round meeting table D.120 with wooden top (4 seats)</i> Table de réunion ronde D.120 avec plan mélaminé (4 Places)</p>	S0722	NCA RM RSB OL GAV GTO BI	AL BI NR XL	Diam.120 H.75,5	3	0,126	56,4	560,00
		590,00						
 <p><b>Tavolo circolare diam.120 piano vetro (4 posti)</b> <i>Round meeting table D.120 with glass top (4 seats)</i> Table de réunion ronde D.120 avec plan en verre (4 Places)</p>	S0722V	VS VN VB VC VR	AL BI NR XL	Diam.120 H.74,2	3	0,154	72,1	1.152,00
			1.182,00					
			1.467,00					
			1.497,00					
			1.497,00					
 <p><b>Tavolo riunione 120x120 piano legno (4 posti)</b> <i>Meeting table 120x120 with wooden top (4 seats)</i> Table de réunion 120x120 avec plan mélaminé (4 Places)</p>	S0722.1	NCA RM RSB OL GAV GTO BI	AL BI NR XL	120 x 120 x 75,5	3	0,123	62,4	639,00
			817,00					
 <p><b>Tavolo circolare 120x120 piano vetro (4 posti)</b> <i>Round meeting table 120x120 with glass top (4 seats)</i> Table de réunion ronde 120x120 avec plan en verre (4 Places)</p>	S0722.1V	VS VN VB VC VR	AL BI NR XL	120 x 120 x 74,2	3	0,151	78,1	1.231,00
			1.409,00					
			1.546,00					
			1.724,00					
			1.724,00					
 <p><b>Tavolo riunione diam.120 piano legno (4 posti)</b> <i>Round meeting table D.120 with wooden top (4 seats)</i> Table de réunion ronde D.120 avec plan mélaminé (4 Places)</p>	SOX722	NCA RM RSB OL GAV GTO BI	AL BI NR CR	Diam.120 H.73	7	0,148	42,0	816,00
			976,00					
 <p><b>Tavolo riunione diam.120 piano vetro (4 posti)</b> <i>Round meeting table D.120 with glass top (4 seats)</i> Table de réunion ronde D.120 avec plan en verre (4 Places)</p>	SOX722V	VS VN VB VC VR	AL BI NR CR	Diam.120 H.73	7	0,177	57,7	1.455,00
			1.616,00					
			1.795,00					
			1.956,00					
			1.956,00					

# DELUXE

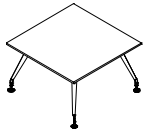
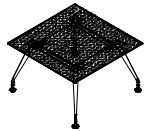
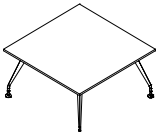
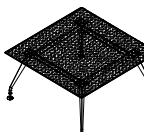
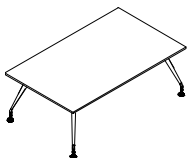
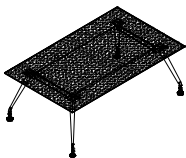
TAVOLI RIUNIONE MEETING TABLES TABLES DE REUNION	CODICE CODE CODE	FINITURA PIAMI TOP FINISHING FIN. PLANS	FINITURA GAMBE LEG FINISHING FINITION PIEDS	L x P x H W x D x H L x P x H	COLLI PACKS COLIS	VOLUMI VOLUME VOLUME	PESO WEIGHT POIDS	PREZZO PRICE PRIX	
								€	
 <p><b>Tavolo riunione 120x120 piano legno (4 posti)</b> <i>Meeting table 120x120 with wooden top (4 seats)</i> Table de réunion 120x120 avec plan mélaminé (4 Places)</p>	SOX700	NCA RM RSB OL GAV GTO BI	AL	120 x 120 x 73	7	0,150	44,0	753,00	
			BI					NR	914,00
 <p><b>Tavolo riunione 120x120 piano vetro (4 posti)</b> <i>Meeting table 120x120 with glass top (4 seats)</i> Table de réunion 120x120 avec plan en verre (4 Places)</p>	SOX700V	VS VN VB VC VR	AL	120 x 120 x 73	7	0,179	62,7	1.413,00	
			BI					NR	1.573,00
			CR					AL	1.680,00
			BI					NR	1.841,00
			CR					CR	
 <p><b>Tavolo riunione L.140x140 piano legno (4-8 posti)</b> <i>Meeting table W.140x140 with wooden top (4-8 seats)</i> Table de réunion L.140x140 avec plan mélaminé (4-8 Places)</p>	SOX700.1	NCA RM RSB OL GAV GTO BI	AL	140 x 140 x 73	7	0,176	55,2	812,00	
			BI					NR	973,00
 <p><b>Tavolo riunione L.140x140 piano vetro (4-8 posti)</b> <i>Meeting table W.140x140 with glass top (4-8 seats)</i> Table de réunion L.140x140 avec plan en verre (4-8 Places)</p>	SOX701.V	VS VN VB VC VR	AL	140 x 140 x 73	7	0,180	80,7	1.671,00	
			BI					NR	1.831,00
			CR					AL	2.035,00
			BI					NR	2.196,00
			CR					CR	
 <p><b>Tavolo riunione L.210x120 piano legno (6-8 posti)</b> <i>Meeting table W.210x120 with wooden top (6-8 seats)</i> Table de réunion L.210x120 avec plan mélaminé (6-8 Places)</p>	SOX705	NCA RM RSB OL GAV GTO BI	AL	210 x 120 x 73	7	0,204	68,7	887,00	
			BI					NR	1.047,00
 <p><b>Tavolo riunione L.210x120 piano vetro (6-8 posti)</b> <i>Meeting table W.210x120 with glass top (6-8 seats)</i> Table de réunion L.210x120 avec plan en verre (6-8 Places)</p>	SOX705V	VS VN VB VC VR	AL	210 x 120 x 73	7	0,251	101,4	1.843,00	
			BI					NR	2.004,00
			CR					AL	2.378,00
			BI					NR	2.539,00
			CR					CR	



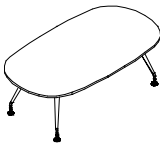
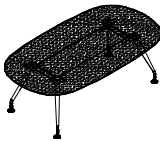
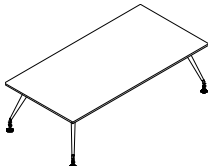
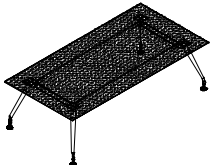
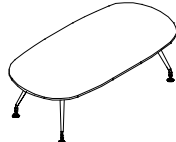
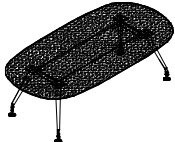

# DELUXE

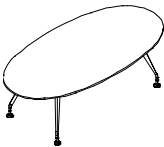
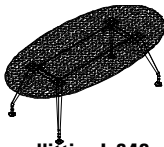
TAVOLI RIUNIONE MEETING TABLES TABLES DE REUNION	CODICE CODE CODE	FINITURA PIANI TOP FINISHING FIN. PLANS	FINITURA GAMBE LEG FINISHING FINITION PIEDS	L x P x H W x D x H L x P x H	COLLI PACKS COLIS	VOLUMI VOLUME VOLUME	PESO WEIGHT POIDS	PREZZO PRICE PRIX
								€
 <p><b>Tavolo riunione L.210x120 piano legno (6-8 posti)</b> <i>Meeting table W.210x120 with wooden top (6-8 seats)</i> Table de réunion L.210x120 avec plan mélaminé (6-8 Places)</p>	SOX715	NCA RM RSB OL GAV GTO BI	AL	210 x 120 x 73	7	0,201	65,5	983,00
			BI NR CR					1.144,00
 <p><b>Tavolo riunione L.210x120 piano vetro (6-8 posti)</b> <i>Meeting table W.210x120 with glass top (6-8 seats)</i> Table de réunion L.210x120 avec plan en verre (6-8 Places)</p>	SOX715V	VS VN VB VC VR	AL BI NR CR	210 x 120 x 73	7	0,248	93,0	1.965,00
			AL BI NR CR					2.125,00
			AL BI NR CR					2.548,00
			AL BI NR CR					2.708,00
 <p><b>Tavolo riunione L.240x120 piano legno (8 posti)</b> <i>Meeting table W.240x120 with wooden top (8 seats)</i> Table de réunion L.240x120 avec plan mélaminé (8 Places)</p>	SOX706	NCA RM RSB OL GAV GTO BI	AL BI NR CR	240 x 120 x 73	7	0,221	76,4	924,00
			AL BI NR CR					1.085,00
 <p><b>Tavolo riunione L.240x120 piano vetro (8 posti)</b> <i>Meeting table W.240x120 with glass top (8 seats)</i> Table de réunion L.240x120 avec plan en verre (8 Places)</p>	SOX706V	VS VN VB VC VR	AL BI NR CR	240 x 120 x 73	7	0,274	113,9	1.971,00
			AL BI NR CR					2.132,00
			AL BI NR CR					2.652,00
			AL BI NR CR					2.812,00
 <p><b>Tavolo riunione L.240 piano legno (8 posti)</b> <i>Meeting table W.240 with wooden top (8 seats)</i> Table de réunion L.240 avec plan mélaminé (8 Places)</p>	SOX716	NCA RM RSB OL GAV GTO BI	AL BI NR CR	240 x 120 x 73	7	0,218	73,1	1.022,00
			AL BI NR CR					1.183,00
 <p><b>Tavolo riunione L.240 piano vetro (8 posti)</b> <i>Meeting table W.240 with glass top (8 seats)</i> Table de réunion L.240 avec plan en verre (8 Places)</p>	SOX716V	VS VN VB VC VR	AL BI NR CR	240 x 120 x 73	7	0,271	104,9	2.119,00
			AL BI NR CR					2.279,00
			AL BI NR CR					2.799,00
			AL BI NR CR					2.960,00

# DELUXE

TAVOLI RIUNIONE MEETING TABLES TABLES DE REUNION	CODICE CODE CODE	FINITURA PIANI TOP FINISHING FIN. PLANS	FINITURA GAMBE LEG FINISHING FINITION PIEDS	L x P x H W x D x H L x P x H	COLLI PACKS COLIS	VOLUMI VOLUME VOLUME	PESO WEIGHT POIDS	PREZZO PRICE PRIX
								€
 <p><b>Tavolo riunione ellittico L.240 piano legno (8 posti)</b>  <i>Elliptical meeting table W.240 with wooden top (8 seats)</i>            Table de réunion elliptique L.240 avec plan mélaminé (8 Places)</p>	SOX717	NCA	AL	240 x 120 x 73	7	0,217	72,3	1.014,00
		RM	BI					
		RSB	NR					1.174,00
		OL	CR					
		GAV						
		GTO						
		BI						
 <p><b>Tavolo riunione ellittico L.240 piano vetro (8 posti)</b>  <i>Elliptical meeting table W.240 with glass top (8 seats)</i>            Table de réunion elliptique L.240 avec plan en verre (8 Places)</p>	SOX717V	VS	AL	240 x 120 x 73	7	0,270	104,1	2.110,00
			BI					
		NR	CR					2.271,00
		VN	AL					
		VB	BI					
VC	NR						2.791,00	
		VR	CR					2.951,00

## DELUXE

TAVOLI CAFFÈ COFFEE TABLES TABLES À CAFÈ	CODICE CODE CODE	FINITURA PIANI TOP FINISHING FIN. PLANS	FINITURA GAMBE LEG FINISHING FINITION PIEDS	L x P x H W x D x H L x P x H	COLLI PACKS COLIS	VOLUMI VOLUME VOLUME	PESO WEIGHT POIDS	PREZZO PRICE PRIX	
								€	
 <p><b>Tavolo caffè circolare piano legno diam.60</b> <i>Round coffee table with wooden top diameter 60</i> Table à café ronde avec plan mélaminé diamètre 60</p>	<b>S0783</b>	NCA RM RSB OL GAV GTO BI	AL	Diam.60 H.52,5	3	0,044	21,3	320,00	
			BI					NR	435,00
 <p><b>Tavolo caffè circolare piano vetro diam.60</b> <i>Round coffee table with glass top diameter 60</i> Table à café ronde avec plan en verre diamètre 60</p>	<b>S0783V</b>	VS VN VB VC VR	AL	Diam.60 H.51,2	3	0,053	24,5	592,00	
			BI					NR	707,00
			XL					AL	660,00
			BI					NR	775,00
			VR					XL	
 <p><b>Tavolo caffè 60x60 piano legno</b> <i>Coffee table 60x60 with wooden top</i> Table à café 60x60 avec plan mélaminé</p>	<b>S0783.1</b>	NCA RM RSB OL GAV GTO BI	AL	60 x 60 x 52,5	3	0,052	22,8	324,00	
			BI					NR	448,00
 <p><b>Tavolo caffè 60x60 piano vetro</b> <i>Coffee table 60x60 with glass top</i> Table à café 60x60 avec plan en verre</p>	<b>S0783.1V</b>	VS VN VB VC VR	AL	60 x 60 x 51,2	3	0,061	26,0	596,00	
			BI					NR	721,00
			XL					AL	663,00
			BI					NR	788,00
			VR					XL	



# STUDIOFFICE

## TRILOGY

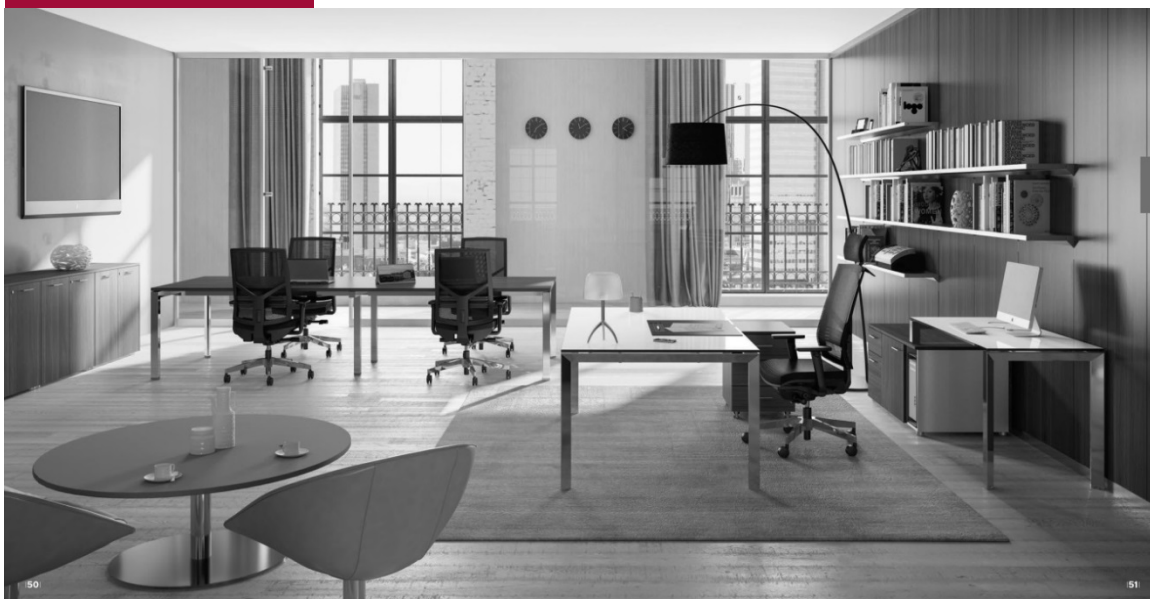

### STRUTTURE SCRIVANIE

Gambe metalliche sezione diamante: disponibili nelle profondità L.60/80/125/165 cm, installabili solo agli estremi della composizione, sono realizzate in tubolare metallico trafilato a sezione trapezoidale (diamante), verniciate a polveri epossidiche nei colori: alluminio, nero lucido bianco o cromato. Sono dotate di piedino livellatore. Nella parte trasversale superiore sono predisposte agganci per il fissaggio della trave portante. Le strutture a ponte "CENTRALI" sono realizzate in tubolare metallico trafilato a sezione quadrata verniciate a polveri epossidiche nei colori alluminio, bianco oppure cromato, dotate di piedino livellatore. Nella parte trasversale superiore sono predisposte agganci per il fissaggio della trave portante. Opzionale, è disponibile il sistema "SLIDING" che permette di far scorrere il piano in orizzontale sulla struttura metallica in modo da accedere e ispezionare facilmente la parte inferiore nella quale viene posizionata la vaschetta per raccogliere i cavi in eccedenza.

### DESKS STRUCTURES

*Diamond metallic terminal structures are available in depth L.60 / 80 / 125 / 165 cm and can be installed at the end of composition only. Structures are made of steel triangular (diamond) section, varnished with epossidic paint in aluminium, gloss black and white colours or chromed with levelling feet. In the basement upper section there are hooks for load bearing beam fixing. CENTRAL metal bridge structures are made of steel square section, varnished with epossidic paint in white and silver colours or chromed, with levelling feet. In the basement upper section there are hooks for fixing the load bearing beam. Central structure is available in two versions: open or closed through steel panelling with 1 fixed side and one which can be inspectionable for wire management. Load bearing beams are made of rectangular section steel, varnished with silver epossidic paints. It is also available the "SLIDING" version that allows the horizontal desktop to slide on the metallic structure so that the lower part can be inspectionable for the placement of exceeding wire management box.*

### STRUCTURES DES BUREAUX

Pied métal à section diamant: disponible dans les profondeurs L.60 ou 80/125/165 cm, pieds à pont TERMINAUX, à installer uniquement dans les extrémités de la composition, sont faits de métal tubulaire dessinées à section trapézoïdale (Diamant), vernis de résine époxy aluminium, noir brillant, blanc ou chromé. Ils sont équipés de pieds réglables. Dans la pièce transversale supérieure sont disposés des crochets de fixation de la poutre de support. Les structures à pont "CENTRALES" sont faites de tubes de métal extrudé avec une section carrée peinte avec poudre époxy couleurs: chromé, aluminium, blanc et équipées de pieds réglables. Dans la partie transversale supérieure sont disposés des crochets de fixation de poutre de support. La structure "CENTRALE" est disponible en deux versions: ouverte ou fermée par des panneaux en acier avec un côté fixe et une face accessible pour la gestion des câbles. Les poutres porteuses sont en acier tubulaire à section rectangulaire extrudée, vernis de résine époxy, couleur aluminium. En option, il y a le système coulissant qui vous permet de faire défiler horizontalement le plan sur la structure métallique afin d'accéder facilement et inspecter la partie inférieure dans laquelle il ya la poche pour les câblages en excès.

01	<b>BI</b> Bianco White Blanc	02	<b>AL</b> Alluminio Aluminium Aluminium	04	<b>NR</b> Nero lucido Gloss black Noir brillant	05	<b>CR</b> Cromato Chrome Chrome
----	---------------------------------------	----	--	----	--	----	--

\*TRILOGY può essere completato con cassettiere, mobili di servizio, contenitori ed accessori consultabili nelle rispettive sezioni da pag. 141 a seguire.

\*TRILOGY can be completed with drawers, service cabinets, cabinets and accessories to be found in the respective sections from page 141 on

\*TRILOGY peut être complété avec caissons mobiles, des meubles de service, des armoires et accessoires disponibles dans les sections correspondantes à partir de la page 141 à suivre



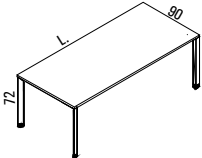
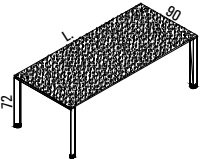
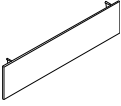
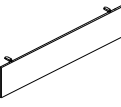

# TRILOGY

SCRIVANIE DIREZIONALI EXECUTIVE DESKS BUREAUX DIRECTION	CODICE CODE CODE	FINITURA PIANI TOP FINISHING FIN. PLANS	FIN. GAMBE LEG FINISHING FINITION PIEDS	L x P x H W x D x H L x P x H	COLLI PACKS COLIS	VOLUMI VOLUME VOLUME	PESO WEIGHT POIDS	PREZZO PRICE PRIX
								€
 <p><b>Scrivania piano legno</b> Desk with wooden top Poste avec plan mélaminé</p>	<b>SOR370</b>	NCA	AL	180 x 90 x 73	4	0,190	48,5	528,00
			BI					858,00
			NR					
	<b>SOR371</b>	RM	AL	200 x 90 x 73	4	0,199	52,8	548,00
			BI					878,00
			NR					
	<b>SOR372</b>	OL	AL	220 x 90 x 73	4	0,208	56,9	571,00
			BI					901,00
			NR					
 <p><b>Scrivania piano vetro</b> Desk with glass top Poste avec plan en verre</p>	<b>SOR370V</b>	VS	AL	180 x 90 x 73	4	0,222	69,5	1.134,00
			BI					1.463,00
			NR					1.375,00
			CR					1.704,00
	<b>SOR371V</b>	VN	AL	200 x 90 x 73	4	0,234	76,2	1.185,00
			BI					1.514,00
			NR					1.485,00
			CR					1.814,00
	<b>SOR372V</b>	VR	AL	220 x 90 x 73	4	0,247	82,7	1.261,00
			BI					1.590,00
			NR					1.574,00
			CR					1.903,00
 <p><b>Modesty panel per scrivanie legno</b> Modesty panel for wooden desks Voile de fond pour plan mélaminé</p>	<b>S0605</b>	NCA	Per SOR370 For SOR370 POUR SOR370	L.168 x H.28,4	2	0,020	7,5	63,00
	<b>S0606</b>	RSB	Per SOR371 For SOR371 POUR SOR371	L.188 x H.28,4	2	0,023	8,3	67,00
	<b>S0607</b>	OL	Per SOT372 For SOT372 POUR SOT372	L.208 x H.28,4	2	0,025	9,0	70,00
 <p><b>Modesty panel per scrivanie vetro</b> Modesty panel for glass desks Voile de fond pour plan en verre</p>	<b>S0605V</b>	GTO	Per SOR370V For SOR370V POUR SOR370V	L.168 x H.28,4	1	0,020	7,5	63,00
	<b>S0606V</b>	RM	Per SOR371V For SOR371V POUR SOR371V	L.188 x H.28,4	1	0,023	8,3	67,00
	<b>S0607V</b>	RSB	Per SOR372V For SOR372V POUR SOR372V	L.208 x H.28,4	1	0,025	9,0	70,00

# TRILOGY

Da completare sempre con mobili di servizio portanti L.64,5-80-120-135-160-180 (PAG. 168)

To be completed always with load bearing service cabinet L.64,5-80-120-135-160-180 (PAGE. 168)

A compléter toujours avec meubles porteur L.64,5-80-120-135-160-180 (PAGE. 168)

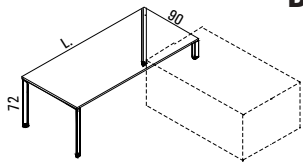
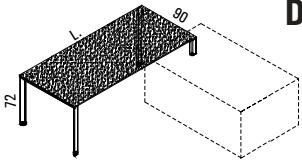
SCRIVANIE DIREZIONALI PORTANTI LOAD BEARING EXECUTIVE DESKS BUREAUX DIRECTION PORTEURS	CODICE CODE CODE	FINITURA PIANI TOP FINISHING FIN. PLANS	FIN. GAMBE LEG FINISHING FINITION PIEDS	L x P x H W x D x H L x P x H	COLLI PACKS COLIS	VOLUMI VOLUME VOLUME	PESO WEIGHT POIDS	PREZZO PRICE PRIX			
								€			
 <p><b>DX</b></p> <p><b>Scrivania piano legno</b> Desk with wooden top Poste avec plan mélaminé</p>	SOR370P DX-SX	NCA	AL	180 x 90 x 73	4	0,190	47,4	587,00			
			BI					898,00			
			NR								
	SOR371P DX-SX	RM	AL	200 x 90 x 73	4	0,199	51,7	607,00			
			BI					919,00			
			NR								
	SOR372P DX-SX	OL	AL	220 x 90 x 73	4	0,208	55,8	630,00			
			BI					941,00			
			NR								
 <p><b>DX</b></p> <p><b>Scrivania piano vetro</b> Desk with glass top Poste avec plan en verre</p>	SOR370PV DX-SX	VS	AL	180 x 90 x 73	4	0,222	68,4	1.192,00			
			BI					1.504,00			
			NR					1.433,00			
			CR					1.745,00			
	SOR371PV DX-SX	VN	VB	AL	180 x 90 x 73	4	0,234	75,1	1.243,00		
				BI					1.555,00		
				NR					1.543,00		
				CR					1.855,00		
	SOR372PV DX-SX	VC	VR	AL	220 x 90 x 73	4	0,247	81,6	1.319,00		
				BI					1.631,00		
				NR					1.632,00		
				CR					1.944,00		
S0605	NCA	RM	Per SOR370P For SOR370P POUR SOR370P	L.168 x H.28,4	2	0,020	7,5	63,00			
			S0606	RSB	OL	Per SOR371P For SOR371P POUR SOR371P	L.188 x H.28,4	2	0,023	8,3	67,00
S0605V	NCA	RM	Per SOR370PV For SOR370PV POUR SOR370PV	L.168 x H.28,4	1	0,020	7,5	63,00			
			S0606V	RSB	OL	Per SOR371PV For SOR371PV POUR SOR371PV	L.188 x H.28,4	1	0,023	8,3	67,00

# TRILOGY



Da completare sempre con mobili di servizio portanti L. 160-180 (PAG.169)

To be completed always with load bearing service cabinet L.160-180 (PAGE.169)

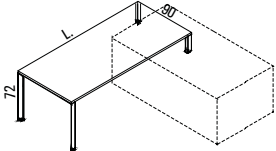
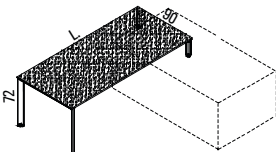
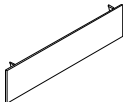
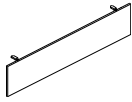
A compléter toujours avec meubles porteur L.160-180 (PAGE.169)

SCRIVANIE DIREZIONALI PORTANTI LOAD BEARING EXECUTIVE DESKS BUREAUX DIRECTION PORTEURS	CODICE CODE CODE	FINITURA PIANI TOP FINISHING FIN. PLANS	FIN. GAMBE LEG FINISHING FINITION PIEDS	L x P x H W x D x H L x P x H	COLLI PACKS COLIS	VOLUMI VOLUME VOLUME	PESO WEIGHT POIDS	PREZZO PRICE PRIX	
								€	
 <p>Scrivania piano legno Desk with wooden top Poste avec plan mélaminé</p>	SOR370PD	NCA	AL	180 x 90 x 73	5	0,212	46,1	571,00	
			BI					804,00	
	SOR371PD	RMB	AL	200 x 90 x 73	5	0,221	50,5	591,00	
			BI					824,00	
	SOR372PD	GTO	AL	220 x 90 x 73	5	0,230	54,6	614,00	
			BI					847,00	
	 <p>Scrivania piano vetro Desk with glass top Poste avec plan en verre</p>	SOR370PDV DX-SX	VS	AL	180 x 90 x 73	5	0,244	67,2	1.177,00
				BI					1.410,00
				NR					1.417,00
CR				1.650,00					
SOR371PDV DX-SX		VS	AL	180 x 90 x 73	5	0,256	73,9	1.228,00	
			BI					1.461,00	
			NR					1.527,00	
			CR					1.760,00	
SOR372PDV DX-SX		VS	AL	220 x 90 x 73	5	0,268	80,3	1.304,00	
			BI					1.537,00	
			NR					1.616,00	
			CR					1.849,00	
 <p>Modesty panel per scrivanie legno Modesty panel for wooden desks Voile de fond pour plan mélaminé</p>	S0603	NCA	Per SOR370PD For SOR370PD POUR SOR370PD	L.128 x H.28,4	2	0,016	5,9	56,00	
	S0604	RSB	Per SOR371PD For SOR371PD POUR SOR371PD	L.148 x H.28,4	2	0,018	6,7	60,00	
	S0605V	GTO	Per SOR372PD For SOR372PD POUR SOR372PD	L.168 x H.28,4	2	0,020	7,5	63,00	
 <p>Modesty panel per scrivanie vetro Modesty panel for glass desks Voile de fond pour plan en verre</p>	S0603V	NCA	Per SOR370PDV For SOR370PDV POUR SOR370PDV	L.128 x H.28,4	1	0,016	5,9	56,00	
	S0604V	RSB	Per SOR371PDV For SOR371PDV POUR SOR371PDV	L.148 x H.28,4	1	0,018	6,7	60,00	
	S0605V	GTO	Per SOR372PDV For SOR372PDV POUR SOR372PDV	L.168 x H.28,4	1	0,020	7,5	63,00	

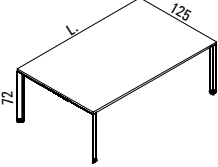
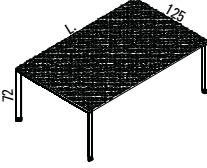
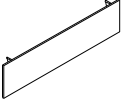
# TRILOGY

SCRIVANIE DIREZIONALI EXECUTIVE DESKS BUREAUX DIRECTION	CODICE CODE CODE	FINITURA PIANI TOP FINISHING FIN. PLANS	FIN. GAMBE LEG FINISHING FINITION PIEDS	L x P x H W x D x H L x P x H	COLLI PACKS COLIS	VOLUMI VOLUME VOLUME	PESO WEIGHT POIDS	PREZZO PRICE PRIX	
								€	
 <p><b>Scrivania piano legno</b> Desk with wooden top Poste avec plan mélaminé</p>	SOR390	NCA	AL	180 x 125 x 72	7	0,165	64,3	692,00	
			BI					1.109,00	
	SOR391	RMB	AL	200 x 125 x 72	7	0,177	70,0	717,00	
			BI					1.135,00	
	SOR392	GTO	AL	220 x 125 x 72	7	0,189	75,4	746,00	
			BI					1.163,00	
	 <p><b>Scrivania piano vetro</b> Desk with glass top Poste avec plan en verre</p>	SOR390V	VS	AL	180 x 125 x 72	7	0,207	93,5	1.436,00
				BI					1.854,00
				NR					1.801,00
CR				2.218,00					
SOR391V		VS	VS	AL	200 x 125 x 72	7	0,223	102,4	1.519,00
				BI					1.936,00
		NR	1.922,00						
		CR	2.339,00						
SOR392V		VS	VS	AL	220 x 125 x 72	7	0,240	111,1	1.604,00
				BI					2.021,00
	NR	2.047,00							
	CR	2.464,00							
 <p><b>Modesty panel per scrivanie legno</b> Modesty panel for wooden desks Voile de fond pour plan mélaminé</p>	S0605	NCA	Per SOX390 For SOX390 POUR SOX390	L.168 x H.28,4	2	0,020	7,5	63,00	
	S0606	RSB	Per SOX391 For SOX391 POUR SOX391	L.188 x H.28,4	2	0,023	8,3	67,00	
	S0607	GTO	Per SOX392 For SOX392 POUR SOX392	L.208 x H.28,4	2	0,025	9,0	70,00	
 <p><b>Modesty panel per scrivanie vetro</b> Modesty panel for glass desks Voile de fond pour plan en verre</p>	S0605V	NCA	Per SOX390V For SOX390V POUR SOX390V	L.168 x H.28,4	1	0,020	7,5	63,00	
	S0606V	RSB	Per SOX391V For SOX391V POUR SOX391V	L.188 x H.28,4	1	0,023	8,3	67,00	
	S0607V	GTO	Per SOX392V For SOX392V POUR SOX392V	L.208 x H.28,4	1	0,025	9,0	70,00	

# TRILOGY

Da completare sempre con mobili di servizio portanti L.64,5-80-120-135-160-180 (PAG.168)

To be completed always with load bearing service cabinet L.64,5-80-120-135-160-180 (PAGE.168)

A compléter toujours avec meubles porteur L.64,5-80-120-135-160-180 (PAGE.168)

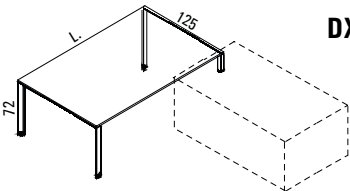
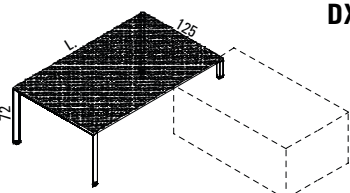
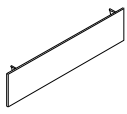
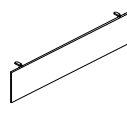
SCRIVANIE DIREZIONALI PORTANTI LOAD BEARING EXECUTIVE DESKS BUREAUX DIRECTION PORTEURS	CODICE CODE CODE	FINITURA PIANI TOP FINISHING FIN. PLANS	FIN. GAMBE LEG FINISHING FINITION PIEDS	L x P x H W x D x H L x P x H	COLLI PACKS COLIS	VOLUMI VOLUME VOLUME	PESO WEIGHT POIDS	PREZZO PRICE PRIX	
								€	
 <p><b>DX</b></p> <p><b>Scrivania piano legno</b> <i>Desk with wooden top</i> Poste avec plan mélaminé</p>	SOR390P DX-SX	NCA	AL	180 x 125 x 72	7	0,157	60,5	804,00	
			BI					1.221,00	
	SOR391P DX-SX	RMB	AL	200 x 125 x 72	7	0,169	66,2	830,00	
			BI					1.246,00	
	SOR392P DX-SX	GTO	AL	220 x 125 x 72	7	0,181	71,6	858,00	
			BI					1.275,00	
	 <p><b>DX</b></p> <p><b>Scrivania piano vetro</b> <i>Desk with glass top</i> Poste avec plan en verre</p>	SOR390PV DX-SX	VS	AL	180 x 125 x 72	7	0,199	89,7	1.549,00
				BI					1.965,00
				NR					1.913,00
CR				2.330,00					
SOR391PV DX-SX		VS	VN	AL	200 x 125 x 72	7	0,215	98,6	1.631,00
				BI					2.048,00
				NR					2.034,00
				CR					2.451,00
SOR392PV DX-SX		VS	VN	AL	220 x 125 x 72	7	0,232	107,3	1.716,00
				BI					2.133,00
	NR			2.160,00					
	CR			2.576,00					
 <p><b>Modesty panel per scrivanie legno</b> <i>Modesty panel for wooden desks</i> Voile de fond pour plan mélaminé</p>	S0605	NCA	Per SOX390P For SOX390P POUR SOX390P	L.168 x H.28,4	2	0,020	7,5	63,00	
	S0606	RSB	Per SOX391P For SOX391P POUR SOX391P	L.188 x H.28,4	2	0,023	8,3	67,00	
	S0607	GTO	Per SOX392P For SOX392P POUR SOX392P	L.208 x H.28,4	2	0,025	9,0	70,00	
 <p><b>Modesty panel per scrivanie vetro</b> <i>Modesty panel for glass desks</i> Voile de fond pour plan en verre</p>	S0605V	NCA	Per SOX390V For SOX390V POUR SOX390V	L.168 x H.28,4	1	0,020	7,5	63,00	
	S0606V	RSB	Per SOX391PV For SOX391PV POUR SOX391PV	L.188 x H.28,4	1	0,023	8,3	67,00	
	S0607V	GTO	Per SOX392PV For SOX392PV POUR SOX392PV	L.208 x H.28,4	1	0,025	9,0	70,00	

# TRILOGY

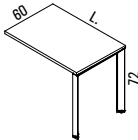
ALLUNGHI LATERALI E FRONTALI LATERAL AND FRONTAL EXTENSION EXTENSIONS LATERALES ET FRONTALE	CODICE CODE CODE	FINITURA PIANI TOP FINISHING FIN. PLANS	FIN. GAMBE LEG FINISHING FINITION PIEDS	L x P x H W x D x H L x P x H	COLLI PACKS COLIS	VOLUMI VOLUME VOLUME	PESO WEIGHT POIDS	PREZZO PRICE PRIX
								€
 <p><b>Allungo laterale o frontale per piani legno</b> <i>Lateral or frontal extension for wooden desks</i> Extension laterale et frontale pour poste mélaminé</p>	SOR311A	NCA RM RSB	AL BI NR	80 x 60 x 72	2	0,097	15,8	206,00
			CR					359,00
			OL GAV GTO					AL BI NR
	BI	CR	363,00					
	SOR314A	BI	AL BI NR	120 x 60 x 72	2	0,108	20,3	225,00
			CR					378,00
			SOR311AV					VS
	CR	837,00						
	VN VB VC VR	AL BI NR CR		612,00				
CR	927,00							
SOR312AV	VS	AL BI NR		90 x 60 x 72	3	0,112	28,6	
		CR	859,00					
		VN VB VC VR	AL BI NR CR					657,00
		CR	972,00					
		SOR314AV	VS					AL BI NR
CR	921,00							
VN VB VC VR	AL BI NR CR			750,00				
CR	1.065,00							

# TRILOGY

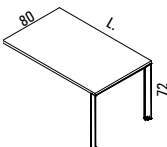
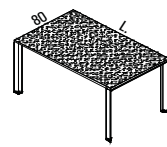
ALLUNGHI FRONTALI FRONTAL EXTENSION EXTENSIONS FRONTALE	CODICE CODE CODE	FINITURA PIANI TOP FINISHING FIN. PLANS	FIN. GAMBE LEG FINISHING FINITION PIEDS	L x P x H W x D x H L x P x H	COLLI PACKS COLIS	VOLUMI VOLUME VOLUME	PESO WEIGHT POIDS	PREZZO PRICE PRIX	
								€	
 <p><b>Allungo frontale per piani legno</b> <i>Frontal extension for wooden desks</i> Extension frontale pour poste mélaminé</p>	SOR348F	NCA	AL	120 x 80 x 72	2	0,132	21,0	229,00	
			BI					400,00	
	SOR349F	RMSB	AL	140 x 80 x 72	2	0,137	23,3	239,00	
			BI					410,00	
	SOR350F	GTO	AL	160 x 80 x 72	2	0,143	25,6	248,00	
			BI					419,00	
	 <p><b>Allungo frontale per piani legno/vetro</b> <i>Frontal extension for woden/glass desks</i> Extension frontale pour poste mélaminé/verre</p>	SOR348FV	VS	AL	120 x 80 x 72	3	0,164	44,0	715,00
				BI					1.068,00
				NR					918,00
CR				1.271,00					
SOR349FV		VN	VS	AL	140 x 80 x 73	3	0,175	49,4	763,00
				BI					1.116,00
				NR					988,00
				CR					1.341,00
SOD350FV		VR	VS	AL	160 x 80 x 73	3	0,185	54,5	808,00
				BI					1.161,00
				NR					1.078,00
				CR					1.431,00

# TRILOGY

Da completare sempre con mobili di servizio portanti L.64,5-80-120-135-160-180 (PAG.168)

To be completed always with load bearing service cabinet L.64,5-80-120-135-160-180 (PAGE.168)

A compléter toujours avec meubles porteur L.64,5-80-120-135-160-180 (PAGE.168)

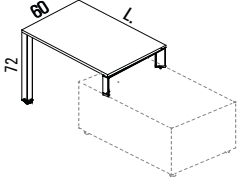
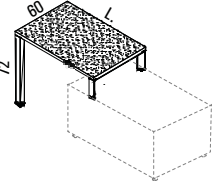
TAVOLI DATILO PORTANTI LOAD BEARING TYPING DESKS TABLES DACTYLO PORTEURS	CODICE CODE CODE	FINITURA PIANI TOP FINISHING FIN. PLANS	FIN. GAMBE LEG FINISHING FINITION PIEDS	L x P x H W x D x H L x P x H	COLLI PACKS COLIS	VOLUMI VOLUME VOLUME	PESO WEIGHT POIDS	PREZZO PRICE PRIX
								€
 <p><b>Tavolo dattilo portante piano legno</b> Load bearing wooden typing desk Table dactylo porteur mélaminé</p>	SOR311D	NCA RM RSB	AL	80 x 60 x 72	4	0,113	19,5	414,00
			BI					716,00
			NR					
	SOR312D	OL GAV GTO	AL	90 x 60 x 72	4	0,117	21,4	425,00
			BI					727,00
			NR					
	SOR314D	BI	AL	120 x 60 x 72	4	0,126	25,1	442,00
			BI					744,00
			NR					
 <p><b>Tavolo dattilo portante piano vetro</b> Load bearing glass typing desk Table dactylo porteur en verre</p>	SOR311DV	VS	AL	80 x 60 x 72	4	0,125	25,8	601,00
			BI					903,00
			NR					
			CR					
	SOR312DV	VN VB VC VR	AL	90 x 60 x 72	4	0,129	28,4	691,00
			BI					993,00
			NR					
			CR					
	SOR314DV	VS	AL	120 x 60 x 72	4	0,141	34,4	630,00
			BI					932,00
			NR					742,00
			CR					1.045,00
SOR314DV	VN VB VC VR	AL	120 x 60 x 72	4	0,141	34,4	691,00	
		BI					994,00	
		NR					835,00	
		CR					1.138,00	

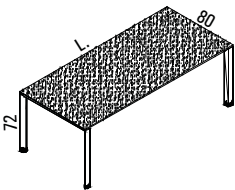
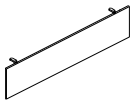
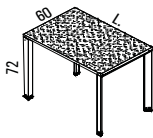

# TRILOGY

SCRIVANIE DIREZIONALI EXECUTIVE DESKS BUREAUX DIRECTION	CODICE CODE CODE	FINITURA PIANI TOP FINISHING FIN. PLANS	FIN. GAMBE LEG FINISHING FINITION PIEDS	L x P x H W x D x H L x P x H	COLLI PACKS COLIS	VOLUMI VOLUME VOLUME	PESO WEIGHT POIDS	PREZZO	
								PRICE PRIX €	
 <p><b>Scrivania piano vetro</b> <i>Desk with glass top</i> Poste avec plan en verre</p>	SOR305V	VS	AL	180 x 80 x 73	3	0,196	60,4	927,00	
			BI					1.280,00	
		NR	1.152,00						
		CR	1.505,00						
	SOR306V	VS	AL	200 x 80 x 73	3	0,207	66,0	975,00	
			BI					1.328,00	
		NR	1.223,00						
		CR	1.576,00						
	SOR306V	VN	AL	200 x 80 x 73	3	0,207	66,0	1.223,00	
			BI					1.576,00	
		NR	1.223,00						
		CR	1.576,00						
 <p><b>Modesty panel per scrivanie vetro</b> <i>Modesty panel for glass desks</i> Voile de fond pour plan en verre</p>	S0605V	NCA	Per SOR305V For SOR305V POUR SOR305V	L.168 x H.28,4	1	0,020	7,5	63,00	
	S0606V	RSB	Per SOR306V For SOR306V POUR SOR306V	L.188 x H.28,4	1	0,023	8,3	67,00	
		OL							
		GAV							
		GTO							
		BI							
 <p><b>Allungo laterale o frontale per piani vetro</b> <i>Lateral or frontal extension for glass desks</i> Extension laterale et frontale pour poste en verre</p>	SOR311AV	VS	AL	80 x 60 x 72	3	0,108	26,7	522,00	
			BI					837,00	
		NR	612,00						
		CR	927,00						
	SOR312AV	VS	AL	90 x 60 x 72	3	0,112	28,6	545,00	
			BI					859,00	
		NR	657,00						
		CR	972,00						
	SOR312AV	VN	AL	90 x 60 x 72	3	0,112	28,6	657,00	
			BI					972,00	
		NR	657,00						
		CR	972,00						
	SOR314V	VS	AL	120 x 60 x 72	3	0,125	34,7	606,00	
			BI					921,00	
		NR	750,00						
		CR	1.065,00						
SOR314V	VN	AL	120 x 60 x 72	3	0,125	34,7	750,00		
		BI					1.065,00		
	NR	750,00							
	CR	1.065,00							

# TRILOGY

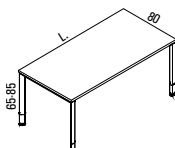
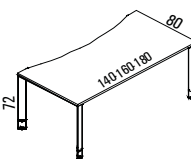
SCRIVANIE OPERATIVE REGOLABILI OPERATIVE ADJUSTABLE DESKS BUREAUX OPÉRATIONNELS RÉGLABLES	CODICE CODE CODE	FINITURA PIANI TOP FINISHING FIN. PLANS	FIN. GAMBE LEG FINISHING FINITION PIEDS	L x P x H W x D x H L x P x H	COLLI PACKS COLIS	VOLUMI VOLUME VOLUME	PESO WEIGHT POIDS	PREZZO PRICE PRIX
								€
 <p><b>H.65/85</b></p> <p>Scrivania con gambe <b>REGOLABILI</b>, profondità <b>cm.80</b> Desk with <b>ADJUSTABLE</b> legs, depth <b>cm.80</b> <i>Poste pieds <b>REGLABLES</b> profondeur <b>cm.80</b></i></p>	<b>SOR300R</b>	<b>NCA RM RSB OL GAV GTO BI</b>	<b>AL</b>	80 x 80 x 65/85	3	0,129	25,3	<b>480,00</b>
	<b>BI</b>							
	<b>NR</b>							
	<b>SOR302R</b>		<b>AL</b>	120 x 80 x 65/85	3	0,144	32,1	<b>512,00</b>
	<b>BI</b>							
	<b>NR</b>							
	<b>SOR303R</b>		<b>AL</b>	140 x 80 x 65/85	3	0,152	35,4	<b>528,00</b>
	<b>BI</b>							
	<b>NR</b>							
	<b>SOR304R</b>		<b>AL</b>	160 x 80 x 65/85	3	0,160	38,9	<b>544,00</b>
	<b>BI</b>							
	<b>NR</b>							
<b>SOR305R</b>	<b>AL</b>	180 x 80 x 65/85	3	0,167	42,3	<b>559,00</b>		
<b>BI</b>								
<b>NR</b>								
<b>SOR306R</b>	<b>AL</b>	200 x 80 x 65/85	3	0,175	45,8	<b>575,00</b>		
<b>BI</b>								
<b>NR</b>								
 <p><b>H.65/85</b></p> <p>Scrivania sagomata con gambe <b>REGOLABILI</b>, profondità <b>cm.80</b> Shaped desk with <b>ADJUSTABLE</b> legs, depth <b>cm.80</b> <i>Poste plan double vague pieds <b>REGLABLES</b> profondeur <b>cm.80</b></i></p>	<b>SOR320R</b>	<b>NCA RM RSB OL GAV GTO BI</b>	<b>AL</b>	140 x 80 x 65/85	3	0,152	35,4	<b>579,00</b>
	<b>BI</b>							
	<b>NR</b>							
	<b>SOR321R</b>		<b>AL</b>	160 x 80 x 65/85	3	0,160	38,9	<b>595,00</b>
	<b>BI</b>							
	<b>NR</b>							
	<b>SOR322R</b>		<b>AL</b>	180 x 80 x 65/85	3	0,167	42,3	<b>610,00</b>
	<b>BI</b>							
	<b>NR</b>							

# TRILOGY

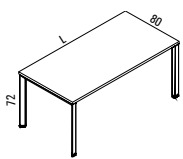
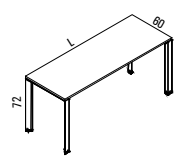
SCRIVANIE OPERATIVE OPERATIVE DESKS BUREAUX OPÉRATIONNELS	CODICE CODE CODE	FINITURA PIANI TOP FINISHING FIN. PLANS	FIN. GAMBE LEG FINISHING FINITION PIEDS	L x P x H W x D x H L x P x H	COLLI PACKS COLIS	VOLUMI VOLUME VOLUME	PESO WEIGHT POIDS	PREZZO PRICE PRIX
								€
 <p><b>Scrivania profondità cm.80</b> Desk depth cm.80 Poste profondeur cm.80</p>	SOR300	NCA RM RSB OL GAV GTO BI	AL	80 x 80 x 72	3	0,129	24,7	354,00
			BI					
			NR					
	SOR302		AL	120 x 80 x 72	3	0,144	31,5	386,00
			BI					
			NR					
	SOR303		AL	140 x 80 x 72	3	0,152	34,8	402,00
			BI					
			NR					
	SOR304		AL	160 x 80 x 72	3	0,160	38,3	418,00
			BI					
			NR					
SOR305	AL	180 x 80 x 72	3	0,167	41,7	433,00		
	BI							
	NR							
SOR306	AL	200 x 80 x 72	3	0,175	45,2	449,00		
	BI							
	NR							
 <p><b>Scrivania profondità cm.60</b> Desk depth cm.60 Poste profondeur cm.60</p>	SOR311	AL	80 x 60 x 72	3	0,097	20,4	335,00	
		BI						
		NR						
	SOR313	AL	100 x 60 x 72	3	0,103	23,1	348,00	
		BI						
		NR						
	SOR314	AL	120 x 60 x 72	3	0,109	25,7	360,00	
		BI						
		NR						
	SOR315	AL	140 x 60 x 72	3	0,115	28,3	373,00	
		BI						
		NR						
SOR316	AL	160 x 60 x 72	3	0,121	30,9	386,00		
	BI							
	NR							
SOR317	AL	180 x 60 x 72	3	0,143	40,4	398,00		
	BI							
	NR							
SOR318	AL	200 x 60 x 72	3	0,151	43,9	411,00		
	BI							
	NR							

# TRILOGY

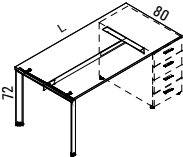
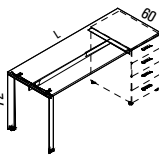
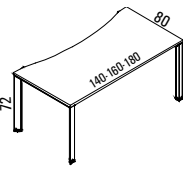
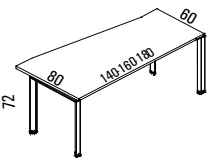
SCRIVANIE OPERATIVE OPERATIVE DESKS BUREAUX OPÉRATIONNELS	CODICE CODE CODE	FINITURA PIANI TOP FINISHING FIN. PLANS	FIN. GAMBE LEG FINISHING FINITION PIEDS	L x P x H W x D x H L x P x H	COLLI PACKS COLIS	VOLUMI VOLUME VOLUME	PESO WEIGHT POIDS	PREZZO PRICE PRIX
								€
 <p><b>DX</b></p> <p><b>Scrivania portante profondità cm.80</b> Load bearing desk depth cm.80 <i>Poste porteur profondeur cm.80</i></p>	<b>SOR303S DX-SX</b>	<b>NCA RM OL RSB GAV GTO BI</b>	<b>AL</b>	140 x 80 x 72	4	0,182	31,0	<b>306,00</b>
	<b>SOR304S DX-SX</b>		<b>BI</b>					
	<b>SOR305S DX-SX</b>		<b>NR</b>					
	<b>SOR306S DX-SX</b>		<b>AL</b>	160 x 80 x 72	4	0,190	34,4	<b>321,00</b>
<b>SOR306S DX-SX</b>	<b>BI</b>							
<b>SOR306S DX-SX</b>	<b>NR</b>							
 <p><b>DX</b></p> <p><b>Scrivania portante profondità cm.60</b> Load bearing desk depth cm.60 <i>Poste porteur profondeur cm.60</i></p>	<b>SOR315S DX-SX</b>	<b>NCA RM RSB OL GAV GTO BI</b>	<b>AL</b>	140 x 60 x 72	4	0,145	25,0	<b>279,00</b>
	<b>SOR316S DX-SX</b>		<b>BI</b>					
	<b>SOR317S DX-SX</b>		<b>NR</b>					
	<b>SOR318S DX-SX</b>		<b>AL</b>	160 x 60 x 72	4	0,151	27,6	<b>292,00</b>
<b>SOR318S DX-SX</b>	<b>BI</b>							
<b>SOR318S DX-SX</b>	<b>NR</b>							
 <p><b>Scrivania sagomata profondità cm.80</b> Shaped desk depth cm.80 <i>Poste double vague profondeur cm.80</i></p>	<b>SOR320</b>	<b>NCA RM RSB OL GAV GTO BI</b>	<b>AL</b>	140 x 80 x 72	3	0,152	34,8	<b>453,00</b>
	<b>SOR321</b>		<b>BI</b>					
	<b>SOR322</b>		<b>NR</b>	160 x 80 x 72	3	0,160	38,3	<b>469,00</b>
<b>SOR322</b>	<b>BI</b>							
 <p><b>DX</b></p> <p><b>Scrivania sagomata profondità cm.60/80</b> Shaped desk depth cm.60/80 <i>Poste vague profondeur cm.60/80</i></p>	<b>SOR325 DX-SX</b>	<b>NCA RM RSB OL GAV GTO BI</b>	<b>AL</b>	140 x 60/80 x 72	3	0,128	33,6	<b>446,00</b>
	<b>SOR326 DX-SX</b>		<b>BI</b>					
	<b>SOR327 DX-SX</b>		<b>NR</b>	160 x 60/80 x 72	3	0,136	37,0	<b>463,00</b>
<b>SOR327 DX-SX</b>	<b>BI</b>							
<b>SOR327 DX-SX</b>	<b>NR</b>	180 x 60/80 x 72	3	0,143	40,4	<b>478,00</b>		
<b>SOR327 DX-SX</b>	<b>BI</b>							

# TRILOGY

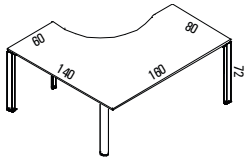
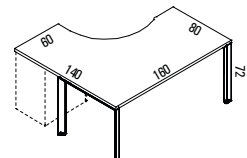
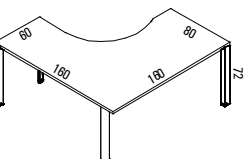
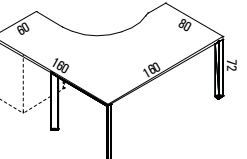
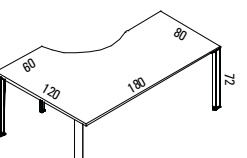
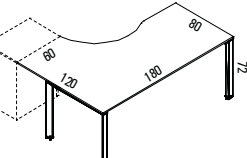
<b>SCRIVANIE OPERATIVE</b> <b>OPERATIVE DESKS</b> <b>BUREAUX OPÉRATIONNELS</b>	<b>CODICE</b> <b>CODE</b> <b>CODE</b>	<b>FINITURA</b> <b>PIANI</b> <b>TOP FINISHING</b> <b>FIN. PLANS</b>	<b>FIN. GAMBE</b> <b>LEG FINISHING</b> <b>FINITION PIEDS</b>	<b>L x P x H</b> <b>W x D x H</b> <b>L x P x H</b>	<b>COLLI</b> <b>PACKS</b> <b>COLIS</b>	<b>VOLUMI</b> <b>VOLUME</b> <b>VOLUME</b>	<b>PESO</b> <b>WEIGHT</b> <b>POIDS</b>	<b>PREZZO</b> <b>PRICE</b> <b>PRIX</b> <b>€</b>
 <p><b>Scrivania angolare</b> Workstation <i>Poste plan compact</i></p>	<b>SOR330</b> <b>DX-SX</b>	<b>NCA</b> <b>RM</b> <b>RSB</b> <b>OL</b> <b>GAV</b> <b>GTO</b> <b>BI</b>	<b>AL</b>  <b>BI</b>  <b>NR</b>	160 x 140 x 72	6	0,293	61,3	<b>643,00</b>
 <p><b>Scrivania angolare per cassettera portante</b> Workstation for load bearing drawer pedestal <i>Poste plan compact pour hauteur bureau</i></p>	<b>SOR330P</b> <b>DX-SX</b>	<b>NCA</b> <b>RM</b> <b>RSB</b> <b>OL</b> <b>GAV</b> <b>GTO</b> <b>BI</b>	<b>AL</b>  <b>BI</b>  <b>NR</b>	160 x 140 x 72	3	0,203	56,5	<b>558,00</b>
 <p><b>Scrivania angolare</b> Workstation <i>Poste plan compact</i></p>	<b>SOR331</b> <b>DX-SX</b>	<b>NCA</b> <b>RM</b> <b>RSB</b> <b>OL</b> <b>GAV</b> <b>GTO</b> <b>BI</b>	<b>AL</b>  <b>BI</b>  <b>NR</b>	160 x 160 x 72	6	0,308	68,0	<b>675,00</b>
 <p><b>Scrivania angolare per cassettera portante</b> Workstation for load bearing drawer pedestal <i>Poste plan compact pour hauteur bureau</i></p>	<b>SOR331P</b> <b>DX-SX</b>	<b>NCA</b> <b>RM</b> <b>RSB</b> <b>OL</b> <b>GAV</b> <b>GTO</b> <b>BI</b>	<b>AL</b>  <b>BI</b>  <b>NR</b>	160 x 160 x 72	3	0,218	62,6	<b>583,00</b>
 <p><b>Scrivania angolare</b> Workstation <i>Poste plan compact</i></p>	<b>SOR332</b> <b>DX-SX</b>	<b>NCA</b> <b>RM</b> <b>RSB</b> <b>OL</b> <b>GAV</b> <b>GTO</b> <b>BI</b>	<b>AL</b>  <b>BI</b>  <b>NR</b>	180 x 120 x 72	6	0,290	60,0	<b>640,00</b>
 <p><b>Scrivania angolare per cassettera portante</b> Workstation for load bearing drawer pedestal <i>Poste plan compact pour hauteur bureau</i></p>	<b>SOR332P</b> <b>DX-SX</b>	<b>NCA</b> <b>RM</b> <b>RSB</b> <b>OL</b> <b>GAV</b> <b>GTO</b> <b>BI</b>	<b>AL</b>  <b>BI</b>  <b>NR</b>	180 x 120 x 72	3	0,200	55,3	<b>554,00</b>

# TRILOGY

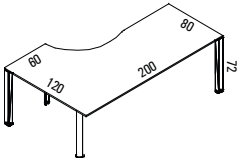
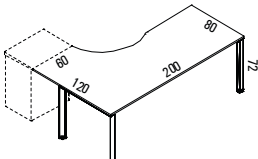
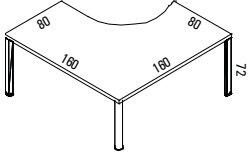
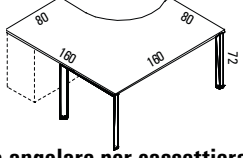
SCRIVANIE OPERATIVE OPERATIVE DESKS BUREAUX OPÉRATIONNELS	CODICE CODE CODE	FINITURA PIANI TOP FINISHING FIN. PLANS	FIN. GAMBE LEG FINISHING FINITION PIEDS	L x P x H W x D x H L x P x H	COLLI PACKS COLIS	VOLUMI VOLUME VOLUME	PESO WEIGHT POIDS	PREZZO PRICE PRIX
								€
 <p><b>DX</b></p> <p><b>Scrivania angolare</b> Workstation <i>Poste plan compact</i></p>	<b>SOR334 DX-SX</b>	NCA	AL	200 x 120 x 72	6	0,301	65,0	<b>663,00</b>
RM								
RSB								
OL								
GAV	BI	GTO	NR					
GTO								
BI								
BI								
 <p><b>DX</b></p> <p><b>Scrivania angolare per cassetiera portante</b> Workstation for load bearing drawer pedestal <i>Poste plan compact pour hauteur bureau</i></p>	<b>SOR334P DX-SX</b>	NCA	AL	200 x 120 x 72	3	0,211	60,4	<b>576,00</b>
RM								
RSB								
OL								
GAV	BI	GTO	NR					
GTO								
BI								
BI								
 <p><b>DX</b></p> <p><b>Scrivania angolare</b> Workstation <i>Poste plan compact</i></p>	<b>SOR333 DX-SX</b>	NCA	AL	160 x 160 x 72	5	0,236	67,6	<b>669,00</b>
RM								
RSB								
OL								
GAV	BI	GTO	NR					
GTO								
BI								
BI								
 <p><b>DX</b></p> <p><b>Scrivania angolare per cassetiera portante</b> Workstation for load bearing drawer pedestal <i>Poste plan compact pour hauteur bureau</i></p>	<b>SOR333P DX-SX</b>	NCA	AL	160 x 160 x 72	3	0,218	62,6	<b>583,00</b>
RM								
RSB								
OL								
GAV	BI	GTO	NR					
GTO								
BI								
BI								

# TRILOGY

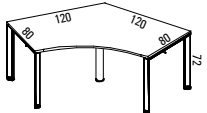
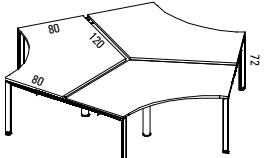
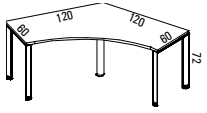
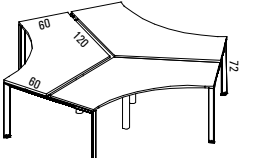

<b>SCRIVANIE OPERATIVE</b> <b>OPERATIVE DESKS</b> <b>BUREAUX OPÉRATIONNELS</b>	<b>CODICE</b> <b>CODE</b> <b>CODE</b>	<b>FINITURA</b> <b>PIANI</b> <b>TOP FINISHING</b> <b>FIN. PLANS</b>	<b>FIN. GAMBE</b> <b>LEG FINISHING</b> <b>FINITION PIEDS</b>	<b>L x P x H</b> <b>W x D x H</b> <b>L x P x H</b>	<b>COLLI</b> <b>PACKS</b> <b>COLIS</b>	<b>VOLUMI</b> <b>VOLUME</b> <b>VOLUME</b>	<b>PESO</b> <b>WEIGHT</b> <b>POIDS</b>	<b>PREZZO</b> <b>PRICE</b> <b>PRIX</b> <b>€</b>
 <p><b>Scrivania angolare 120° P.80</b>  <b>Workstation 120° D.80</b>  <b>Poste plan compact symétrique 120° P.80</b></p>	<b>SOR335</b>	<b>NCA</b> <b>RM</b> <b>RSB</b> <b>OL</b> <b>GAV</b> <b>GTO</b> <b>BI</b>	<b>AL</b> <b>BI</b> <b>NR</b>	208 x 130 x 72	5	0,242	63,4	<b>672,00</b>
 <p><b>N°3 scrivanie angolari 120° P.80/165</b>  <b>N°3 workstation 120° D.80/165</b>  <b>N°3 postes plans compacts symétriques 120° P.80/165</b></p>	<b>SOR335.1</b>	<b>NCA</b> <b>RM</b> <b>RSB</b> <b>OL</b> <b>GAV</b> <b>GTO</b> <b>BI</b>	<b>AL</b> <b>BI</b> <b>NR</b>	293 x 254 x 72	18	0,537	181,8	<b>1.856,00</b>
 <p><b>Scrivania angolare 120° P.60</b>  <b>Workstation 120° D.60</b>  <b>Poste plan compact symétrique 120° P.60</b></p>	<b>SOR336</b>	<b>NCA</b> <b>RM</b> <b>RSB</b> <b>OL</b> <b>GAV</b> <b>GTO</b> <b>BI</b>	<b>AL</b> <b>BI</b> <b>NR</b>	208 x 112 x 72	5	0,203	68,3	<b>640,00</b>
 <p><b>N°3 scrivanie angolari 120° P.60/125</b>  <b>N°3 workstation 120° D.60/125</b>  <b>N°3 postes plans compacts symétriques 120° P.60/125</b></p>	<b>SOR336.1</b>	<b>NCA</b> <b>RM</b> <b>RSB</b> <b>OL</b> <b>GAV</b> <b>GTO</b> <b>BI</b>	<b>AL</b> <b>BI</b> <b>NR</b>	273 x 237 x 72	18	0,474	198,1	<b>1.752,00</b>

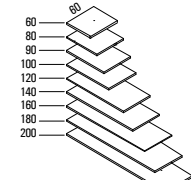
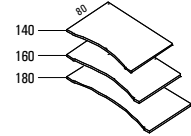
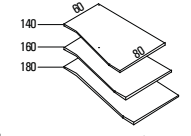
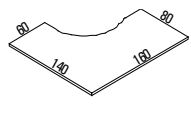
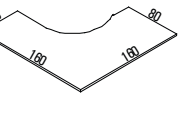
# TRILOGY

PIANI DI LAVORO OPERATIVE DESKS BUREAUX OPÉRATIONNELS	CODICE CODE CODE	FINITURA PIANI TOP FINISHING FIN. PLANS	L x P x SP. W x D x TH. L x P x EP.	COLLI PACKS COLIS	VOLUMI VOLUME VOLUME	PESO WEIGHT POIDS	PREZZO PRICE PRIX €
 <p><b>Piani di lavoro prof. cm.80</b> Desktop depth cm.80 <i>Plan de travail cm.80</i></p>	<b>S0300</b>	<b>NCA</b>	80 x 80 x 2,5	1	0,030	12,2	<b>51,00</b>
	<b>S0301</b>	<b>RM</b>	100 x 80 x 2,5	1	0,038	15,2	<b>64,00</b>
	<b>S0302</b>	<b>RSB</b>	120 x 80 x 2,5	1	0,045	18,2	<b>76,00</b>
	<b>S0303</b>	<b>OL</b>	140 x 80 x 2,5	1	0,052	21,3	<b>89,00</b>
	<b>S0304</b>	<b>GAV</b>	160 x 80 x 2,5	1	0,060	24,3	<b>101,00</b>
	<b>S0305</b>	<b>GTO</b>	180 x 80 x 2,5	1	0,067	27,4	<b>114,00</b>
	<b>S0306</b>	<b>BI</b>	200 x 80 x 2,5	1	0,075	30,4	<b>127,00</b>
 <p><b>Piani di lavoro prof. cm.60</b> Desktop depth cm.80 <i>Plan de travail profondeur cm.80</i></p>	<b>S0310</b>		60 x 60 x 2,5	1	0,017	6,8	<b>29,00</b>
	<b>S0311</b>	<b>NCA</b>	80 x 60 x 2,5	1	0,023	9,1	<b>38,00</b>
	<b>S0312</b>	<b>RM</b>	90 x 60 x 2,5	1	0,026	10,3	<b>43,00</b>
	<b>S0313</b>	<b>RSB</b>	100 x 60 x 2,5	1	0,028	11,4	<b>48,00</b>
	<b>S0314</b>	<b>OL</b>	120 x 60 x 2,5	1	0,034	13,7	<b>57,00</b>
	<b>S0315</b>	<b>GAV</b>	140 x 60 x 2,5	1	0,040	16,0	<b>67,00</b>
	<b>S0316</b>	<b>GTO</b>	160 x 60 x 2,5	1	0,045	18,2	<b>76,00</b>
	<b>S0317</b>	<b>BI</b>	180 x 60 x 2,5	1	0,051	20,5	<b>86,00</b>
	<b>S0318</b>		200 x 60 x 2,5	1	0,056	22,8	<b>95,00</b>
	 <p><b>Piano di lavoro sagomato prof. cm.80</b> Shaped desktop depth cm.80 <i>Plan de travail vague profondeur cm.80</i></p>	<b>S0320</b>	<b>NCA</b>	140 x 80 x 2,5	1	0,052	21,3
<b>S0321</b>		<b>RM</b> <b>RSB</b> <b>OL</b> <b>GAV</b>	160 x 80 x 2,5	1	0,060	24,3	<b>153,00</b>
<b>S0322</b>		<b>GTO</b> <b>BI</b>	180 x 80 x 2,5	1	0,067	27,4	<b>165,00</b>
 <p><b>Piano di lavoro sagomato prof. cm.60/80</b> Shaped desktop depth cm.60/80 <i>Plan de travail vague profondeur cm.60/80</i></p>	<b>S0325</b>	<b>NCA</b>	140 x 60/80x2,5	1	0,052	21,3	<b>140,00</b>
	<b>S0326</b>	<b>RM</b> <b>RSB</b> <b>OL</b> <b>GAV</b>	160 x 60/80x2,5	1	0,060	24,3	<b>153,00</b>
	<b>S0327</b>	<b>GTO</b> <b>BI</b>	180 x 60/80x2,5	1	0,067	27,4	<b>165,00</b>
 <p><b>Piano di lavoro angolare L.160 P.140</b> Worktop W.160 D.140 <i>Plan compact L.160 P.140</i></p>	<b>S0330</b> <b>DX-SX</b>	<b>NCA</b> <b>RM</b> <b>RSB</b> <b>OL</b> <b>GAV</b> <b>GTO</b> <b>BI</b>	160 x 140 x 2,5	1	0,104	42,6	<b>241,00</b>
 <p><b>Piano di lavoro angolare L.160 P.160</b> Worktop W.160 D.160 <i>Plan compact L.160 P.160</i></p>	<b>S0331</b> <b>DX-SX</b>	<b>NCA</b> <b>RM</b> <b>RSB</b> <b>OL</b> <b>GAV</b> <b>GTO</b> <b>BI</b>	160 x 160 x 2,5	1	0,118	48,6	<b>266,00</b>

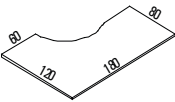

# TRILOGY

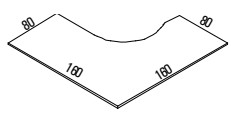
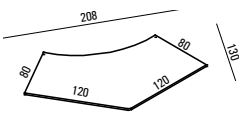
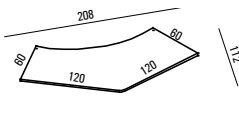
PIANI DI LAVORO OPERATIVE DESKS BUREAUX OPÉRATIONNELS	CODICE CODE CODE	FINITURA PIANI TOP FINISHING FIN. PLANS	L x P x SP. W x D x TH. L x P x EP.	COLLI PACKS COLIS	VOLUMI VOLUME VOLUME	PESO WEIGHT POIDS	PREZZO PRICE PRIX
							€
 <p><b>DX</b></p> <p><b>Piano di lavoro angolare L.180 P.120</b> Worktop W.180 D.120 <i>Plan compact L.180 P.120</i></p>	<b>S0332 DX-SX</b>	NCA RM RSB OL GAV GTO BI	180 x 120 x 2,5	1	0,100	41,0	<b>235,00</b>
 <p><b>DX</b></p> <p><b>Piano di lavoro angolare L.200 P.120</b> Worktop W.200 D.120 <i>Plan compact L.200 P.120</i></p>	<b>S0334 DX-SX</b>	NCA RM RSB OL GAV GTO BI	200 x 120 x 2,5	1	0,111	45,6	<b>254,00</b>
 <p><b>DX</b></p> <p><b>Piano di lavoro angolare L.160 P.160</b> Worktop W.160 D.160 <i>Plan compact L.160 P.160</i></p>	<b>S0333 DX-SX</b>	NCA RM RSB OL GAV GTO BI	160 x 160 x 2,5	1	0,118	48,6	<b>266,00</b>
 <p><b>DX-SX</b></p> <p><b>Piano di lavoro angolare 120° P.80</b> Worktop 120° D.80 <i>Plan compact symétrique 120° P.80</i></p>	<b>S0335 DX-SX</b>	NCA RM RSB OL GAV GTO BI	208 x 130 x 2,5	1	0,125	45,4	<b>279,00</b>
 <p><b>DX-SX</b></p> <p><b>Piano di lavoro angolare 120° P.60</b> Worktop 120° D.60 <i>Plan compact symétrique 120° P.60</i></p>	<b>S0336 DX-SX</b>	NCA RM RSB OL GAV GTO BI	208 x 112 x 2,5	1	0,111	51,6	<b>253,00</b>

# TRILOGY

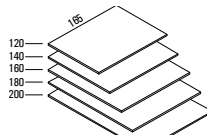
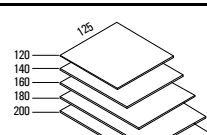
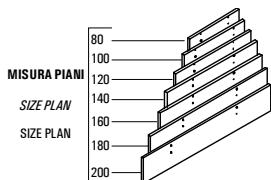
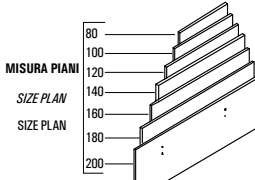
PIANI DI LAVORO POSTAZIONI BENCH E TAVOLI RIUNIONE OPERATIVE DESKS FOR BENCH AND MEETING TABLES BUREAUX OPÉRATIONNELS ET TABLES DE RÉUNION	CODICE CODE CODE	FINITURA PIANI TOP FINISHING FIN. PLANS	L x P x SP. W x D x TH. L x P x EP.	COLLI PACKS COLIS	VOLUMI VOLUME VOLUME	PESO WEIGHT POIDS	PREZZO PRICE PRIX €
 <p><b>Piani di lavoro prof. cm.165</b> Desktop depth cm.165 <i>Plan de travail cm.165</i></p>		<b>NCA</b>					
	<b>S0751</b>	<b>RM</b>	120 x 165 x 2,5	1	0,092	27,8	<b>157,00</b>
	<b>S0752</b>	<b>RSB</b>	140 x 165 x 2,5	1	0,107	32,4	<b>183,00</b>
	<b>S0753</b>	<b>OL</b>	160 x 165 x 2,5	1	0,122	37,0	<b>209,00</b>
	<b>S0754</b>	<b>GAV</b>	180 x 165 x 2,5	1	0,137	41,6	<b>235,00</b>
	<b>S0755</b>	<b>GTO</b>	200 x 165 x 2,5	1	0,152	46,3	<b>261,00</b>
		<b>BI</b>					
 <p><b>Piani di lavoro prof. cm.125</b> Desktop depth cm.125 <i>Plan de travail profondeur cm.125</i></p>		<b>NCA</b>					
	<b>S0761</b>	<b>RM</b>	120 x 125 x 2,5	1	0,070	28,5	<b>119,00</b>
	<b>S0762</b>	<b>RSB</b>	140 x 125 x 2,5	1	0,081	33,3	<b>139,00</b>
	<b>S0763</b>	<b>OL</b>	160 x 125 x 2,5	1	0,093	38,1	<b>159,00</b>
	<b>S0764</b>	<b>GAV</b>	180 x 125 x 2,5	1	0,104	42,8	<b>178,00</b>
	<b>S0765</b>	<b>GTO</b>	200 x 125 x 2,5	1	0,115	47,6	<b>198,00</b>
		<b>BI</b>					
 <p><b>Modesty panel</b> Modesty panel <i>Voile de fond</i></p>	<b>S0600</b>	<b>NCA</b>	68 x 28,4 x 1,8	2	0,009	3,5	<b>46,00</b>
	<b>S0601</b>	<b>RM</b>	88 x 28,4 x 1,8	2	0,011	4,3	<b>49,00</b>
	<b>S0602</b>	<b>RSB</b>	108 x 28,4 x 1,8	2	0,014	5,1	<b>53,00</b>
	<b>S0603</b>	<b>OL</b>	128 x 28,4 x 1,8	2	0,016	5,9	<b>56,00</b>
	<b>S0604</b>	<b>GAV</b>	148 x 28,4 x 1,8	2	0,018	6,7	<b>60,00</b>
	<b>S0605</b>	<b>GTO</b>	168 x 28,4 x 1,8	2	0,020	7,5	<b>63,00</b>
	<b>S0606</b>	<b>BI</b>	188 x 28,4 x 1,8	2	0,023	8,3	<b>67,00</b>
 <p><b>Pannello frontale per scrivanie e tavoli riunione</b> Frontal panel for desks and meeting tables <i>Voile de fond pour postes ou table de réunion</i></p>	<b>S0600.1</b>	<b>NCA</b>	80 x 74 x 1,8	2	0,025	9,0	<b>70,00</b>
	<b>S0601.1</b>	<b>RM</b>	100 x 74 x 1,8	2	0,030	11,1	<b>79,00</b>
	<b>S0602.1</b>	<b>RSB</b>	120 x 74 x 1,8	2	0,036	13,1	<b>88,00</b>
	<b>S0603.1</b>	<b>OL</b>	140 x 74 x 1,8	2	0,042	15,2	<b>97,00</b>
	<b>S0604.1</b>	<b>GAV</b>	160 x 74 x 1,8	2	0,048	17,3	<b>106,00</b>
	<b>S0605.1</b>	<b>GTO</b>	180 x 74 x 1,8	2	0,053	19,3	<b>115,00</b>
	<b>S0606.1</b>	<b>BI</b>	200 x 74 x 1,8	2	0,059	21,4	<b>124,00</b>

# TRILOGY

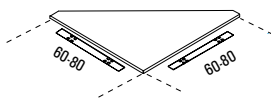
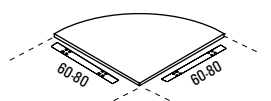
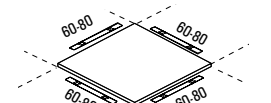
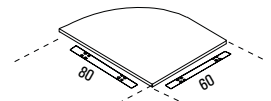
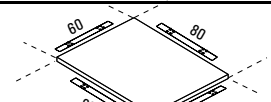
ANGOLI DI COLLEGAMENTO LINKING CORNERS ANGLES DE LIAISON	CODICE CODE CODE	FINITURA PIANI TOP FINISHING FIN. PLANS	L x P x SP. W x D x TH. L x P x EP.	COLLI PACKS COLIS	VOLUMI VOLUME VOLUME	PESO WEIGHT POIDS	PREZZO PRICE PRIX €
 <p><b>Angolo di collegamento 2 vie a 90°</b> 2-way 90° linking angle <i>Angle de liaison à 2 voies</i></p>	<b>S0515</b>	NCA RM RSB OL	80 x 80 x 2,5	1	0,030	13,2	<b>76,00</b>
	<b>S0516</b>	GAV GTO BI	60 x 60 x 2,5	1	0,017	7,8	<b>46,00</b>
 <p><b>Angolo di collegamento 2 vie a 90°</b> 2-way 90° linking angle <i>Angle de liaison à 2 voies</i></p>	<b>S0520</b>	NCA RM RSB OL	80 x 80 x 2,5	1	0,030	13,2	<b>111,00</b>
	<b>S0522</b>	GAV GTO BI	60 x 60 x 2,5	1	0,017	7,8	<b>78,00</b>
 <p><b>Angolo di collegamento 2/3/4 vie</b> 2-3-4 way linking angle <i>Angle de liaison à 2/3/4 voies</i></p>	<b>S0521</b>	NCA RM RSB OL	80 x 80 x 2,5	1	0,030	14,2	<b>85,00</b>
	<b>S0523</b>	GAV GTO BI	60 x 60 x 2,5	1	0,017	8,8	<b>63,00</b>
 <p><b>DX</b></p> <p><b>Angolo di collegamento 2 vie a 90°</b> 2-way 90° linking angle <i>Angle de liaison à 2 voies</i></p>	<b>S0524 DX-SX</b>	NCA RM RSB OL GAV GTO BI	80 x 60 x 2,5	1	0,023	10,1	<b>97,00</b>
 <p><b>Angolo di collegamento 2/3/4 vie</b> 2-3-4 way linking angle <i>Angle de liaison à 2/3/4 voies</i></p>	<b>S0525</b>	NCA RM RSB OL GAV GTO BI	80 x 60 x 2,5	1	0,023	11,1	<b>73,00</b>

# TRILOGY

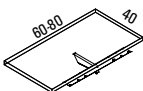
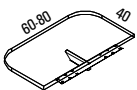
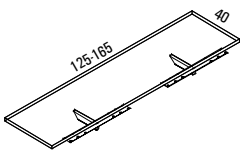
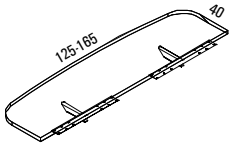
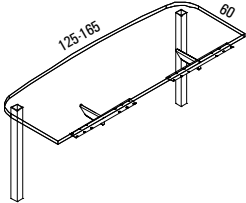
TERMINALI E PENISOLE TERMINALS AND EDGES EXTENSIONS ET CONVIVIALITES	CODICE CODE CODE	FINITURA PIANI TOP FINISHING FIN. PLANS	FIN. GAMBE LEG FINISHING FINITION PIEDS	L x P x SP. W x D x TH. L x P x EP.	COLLI PACKS COLIS	VOLUMI VOLUME VOLUME	PESO WEIGHT POIDS	PREZZO PRICE PRIX
								€
 <b>Terminale</b> Terminal <i>Extension</i>	<b>S0540</b>	NCA RM RSB OL		60 x 40 x 2,5	2	0,012	5,4	<b>48,00</b>
	<b>S0541</b>	GAV GTO BI		80 x 40 x 2,5	2	0,015	7,0	<b>55,00</b>
 <b>Terminale</b> Terminal <i>Extension</i>	<b>S0540.1</b>	NCA RM RSB OL		60 x 40 x 2,5	2	0,012	5,4	<b>83,00</b>
	<b>S0541.1</b>	GAV GTO BI		80 x 40 x 2,5	2	0,015	7,0	<b>90,00</b>
 <b>Terminale</b> Terminal <i>Extension</i>	<b>S0542</b>	NCA RM RSB OL		125,2 x 40 x 2,5	3	0,024	11,3	<b>97,00</b>
	<b>S0544</b>	GAV GTO BI		165,2 x 40 x 2,5	3	0,031	13,9	<b>111,00</b>
 <b>Terminale</b> Terminal <i>Extension</i>	<b>S0542.1</b>	NCA RM RSB OL		125,2 x 40 x 2,5	3	0,024	11,3	<b>154,00</b>
	<b>S0544.1</b>	GAV GTO BI		165,2 x 40 x 2,5	3	0,031	14,3	<b>168,00</b>
 <b>Terminale</b> Terminal <i>Extension</i>	<b>SOR547</b>	NCA RM RSB OL	AL BI NR	125,2 x 60 x 72	5	0,069	20,7	<b>257,00</b>
		GAV GTO BI	CR					<b>355,00</b>
	<b>SOR548</b>	NCA RM RSB OL	AL BI NR	165,2 x 60 x 72	5	0,080	25,3	<b>278,00</b>
		GAV GTO BI	CR					<b>376,00</b>

# TRILOGY

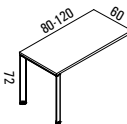
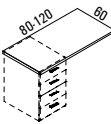
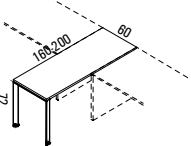
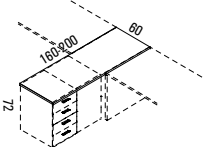
ALLUNGHI LATERALI LATERAL EXTENSIONS EXTENSIONS LATERALES	CODICE CODE CODE	FINITURA PIANI TOP FINISHING FIN. PLANS	FIN. GAMBE LEG FINISHING FINITION PIEDS	L x P x H W x D x H L x P x H	COLLI PACKS COLIS	VOLUMI VOLUME VOLUME	PESO WEIGHT POIDS	PREZZO PRICE PRIX
								€
 <p><b>Allungo laterale</b> Lateral extension <i>Extension laterale</i></p>	<b>SOR410</b>	NCA RM RSB OL	AL BI NR	80 x 60 x 72	2	0,097	15,8	<b>206,00</b>
	<b>SOR411</b>	GAV GTO BI	AL BI NR	120 x 60 x 72	2	0,108	20,3	<b>225,00</b>
 <p><b>Allungo laterale per cassettiere portanti</b> Lateral extension for load bearing drawer pedestals <i>Extension laterale pour caissons hauteur bureau</i></p>	<b>S0410</b>	NCA RM RSB OL		80 x 60 x 72	1	0,023	9,6	<b>47,00</b>
	<b>S0411</b>	GAV GTO BI		120 x 60 x 72	1	0,034	14,2	<b>66,00</b>
ALLUNGHI INTERMEDI CENTRAL EXTENSIONS EXTENSIONS CENTRALE	CODICE CODE CODE	FINITURA PIANI TOP FINISHING FIN. PLANS	FIN. GAMBE LEG FINISHING FINITION PIEDS	L x P x H W x D x H L x P x H	COLLI PACKS COLIS	VOLUMI VOLUME VOLUME	PESO WEIGHT POIDS	PREZZO PRICE PRIX
 <p><b>Allungo intermedio</b> Central extension <i>Extension centrale</i></p>	<b>SOR420</b>	NCA RM RSB OL	AL BI NR	160 x 60 x 72	2	0,119	25,4	<b>252,00</b>
	<b>SOR421</b>	GAV GTO BI	AL BI NR	200 x 60 x 72	2	0,130	29,9	<b>271,00</b>
 <p><b>Allungo intermedio per cassettiere portanti</b> Central extension for load bearing drawer pedestals <i>Extension centrale pour caissons hauteur bureau</i></p>	<b>S0420</b>	NCA RM RSB OL		160 x 60 x 72	1	0,045	19,2	<b>93,00</b>
	<b>S0421</b>	GAV GTO BI		200 x 60 x 72	1	0,056	23,8	<b>112,00</b>

# TRILOGY

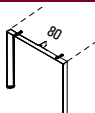
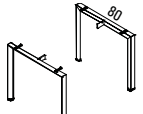
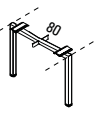
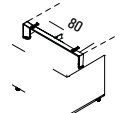
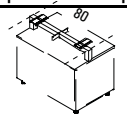
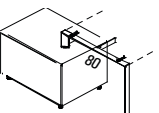
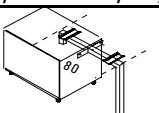
GAMBE METALLICHE P.80 METAL LEGS DEPTH 80 PIETEMENTS METALLIQUES P.80	CODICE CODE CODE	FIN. GAMBE LEG FINISHING FINITION PIEDS	L x H. W x H. L x P x H.	COLLI PACKS COLIS	VOLUMI VOLUME VOLUME	PESO WEIGHT POIDS	PREZZO
							PRICE PRIX €
 <p><b>Gamba metallica finale piani Prof.80</b> Final metal leg for desktops depth 80 <i>Pied métallique pour plans prof. 80</i></p>	SOR001F	AL	80 x 69,5	1	0,097	6,5	149,00
		BI					320,00
 <p><b>Coppia gambe metalliche finali per piani P.80</b> Two final metal legs for desktops depth 80 <i>Jeu de pieds métalliques pour plans prof. 80</i></p>	SOR002F	AL	80 x 69,5	1	0,097	11,5	284,00
		BI					637,00
 <p><b>Gamba metallica centrale "QUADRATA" per 2 piani P.80</b> Central "SQUARE" metal leg for 2 desktops depth 80 <i>Pied métallique centrale "CARRE" pour 2 plans prof. 80</i></p>	SOQ003C	NR	80 x 69,5	1	0,042	6,5	102,00
		BI					266,00
 <p><b>Gamba metallica portante finale per piani prof. 80</b> Load bearing final metal leg for desktops depth 80 <i>Pied métallique porteur finale pour plans prof. 80</i></p>	SOR004F	NR	80 x 69,5	1	0,016	3,6	212,00
		BI					362,00
 <p><b>Gamba metallica portante centrale "QUADRATA" per 2 piani P.80</b> Load bearing central "SQUARE" metal leg for 2 desktops depth 80 <i>Pied métallique "CARRE" centrale pour 2 plans prof.80</i></p>	SOQ004C	NR	80 x 69,5	1	0,016	3,8	150,00
		BI					279,00
 <p><b>Gamba metallica portante finale per piani prof. 80</b> Load bearing final metal leg for desktops depth 80 <i>Pied métallique porteur finale pour plans prof. 80</i></p>	SOR005F DX-SX	NR	80 x 69,5	1	0,026	4,7	185,00
		BI					336,00
 <p><b>Gamba metallica portante centrale "QUADRATA" per 2 piani prof.80</b> Central "SQUARE" metal leg for 2 desktops depth 80 <i>Pied métallique "CARRE" centrale pour 2 plans prof. 80</i></p>	SOQ005C DX-SX	NR	80 x 69,5	1	0,042	5,3	127,00
		BI					252,00

# TRILOGY

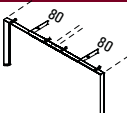
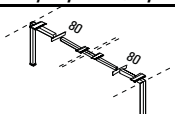
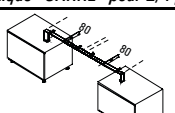
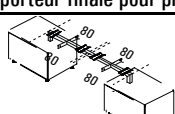
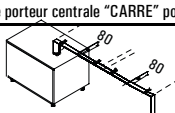
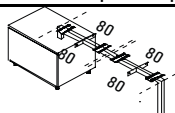
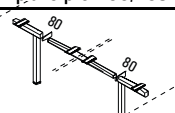
<b>GAMBE METALLICHE P.165</b> <b>METAL LEGS DEPTH 165</b> <b>PIETEMENTS METALLIQUES P.165</b>	<b>CODICE</b> <b>CODE</b> <b>CODE</b>		<b>FIN. GAMBE</b> <b>LEG FINISHING</b> <b>FINITION PIEDS</b>	<b>L x H.</b> <b>W x H.</b> <b>L x P x H.</b>	<b>COLLI</b> <b>PACKS</b> <b>COLIS</b>	<b>VOLUMI</b> <b>VOLUME</b> <b>VOLUME</b>	<b>PESO</b> <b>WEIGHT</b> <b>POIDS</b>	<b>PREZZO</b> <b>PRICE</b> <b>PRIX</b> <b>€</b>
 <p><b>Gamba metallica doppia finale 1/2 piani Prof.80/165</b> <b>Final double metal leg for 1/2 desktops depth 80/165</b> <b>Pied double métallique pour 1/2 plans prof. 80/165</b></p>	<b>SOR006F</b>		<b>AL</b> <b>BI</b> <b>NR</b>	165 x 69,5	2	0,033	8,7	230,00
			<b>CR</b>					456,00
 <p><b>Gamba metallica doppia centrale "QUADRATA" 2/4 piani Prof.80/165</b> <b>Central "SQUARE" double metal leg for desktops depth 80/165</b> <b>Pied double métallique "CARRE" pour 2/4 plans prof. 80/165</b></p>	<b>SQ0006C</b>		<b>AL</b> <b>BI</b> <b>NR</b>	166 x 69,5	2	0,049	9,6	154,00
			<b>CR</b>					401,00
 <p><b>Gamba metallica doppia portante finale per 2 piani prof. 80/165</b> <b>Load bearing final metal leg for desktops depth 80/165</b> <b>Pied métallique porteur finale pour plans prof. 80/165</b></p>	<b>SOR007F</b>		<b>AL</b> <b>BI</b> <b>NR</b>	167 x 69,5	2	0,023	6,4	284,00
			<b>CR</b>					507,00
 <p><b>Gamba metallica portante doppia centrale "QUADRATA" per 2/4 piani prof.80/165</b> <b>Double load bearing central "SQUARE" metal leg for 2/4 plans depth 80/165</b> <b>Pied métallique double porteur centrale "CARRE" pour 2/4 plans prof.80/165</b></p>	<b>SQ0007C</b>		<b>AL</b> <b>BI</b> <b>NR</b>	168 x 69,5	2	0,023	6,9	202,00
			<b>CR</b>					414,00
 <p><b>Gamba metallica portante finale per 1/2piani prof. 80/165</b> <b>Load bearing final metal leg for 1/2 desktops depth 80/165</b> <b>Pied métallique porteur finale pour 1/2 plans prof. 80/165</b></p>	<b>SOR008F</b> <b>DX-SX</b>		<b>AL</b> <b>BI</b> <b>NR</b>	169 x 69,5	2	0,033	7,6	257,00
			<b>CR</b>					482,00
 <p><b>Gamba metallica portante doppia centrale "QUADRATA" per 2/4 piani P.80/165</b> <b>Load bearing central "SQUARE" double metal leg for 2/4 desktops depth 80/165</b> <b>Pied métallique porteur double finale "CARRE" pour 2/4 plans prof. 80/165</b></p>	<b>SQ0008C</b>		<b>AL</b> <b>BI</b> <b>NR</b>	165 x 69,5	2	0,049	8,4	178,00
			<b>CR</b>					387,00
 <p><b>Gamba metallica rientrata doppia finale/centrale "QUADRATA" per 2/4 piani prof.80/165</b> <b>Double inner final/central "SQUARE" metal leg for 2/4 plans depth 80/165</b> <b>Pied métallique double rentré finale/centrale "CARRE" pour 2/4 plans prof.80/165</b></p>	<b>SQ0009C</b>		<b>AL</b> <b>BI</b> <b>NR</b>	145 x 69,5	2	0,041	9,1	149,00
			<b>CR</b>					391,00

# TRILOGY

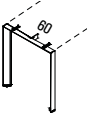
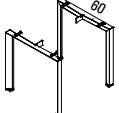
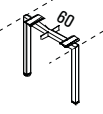
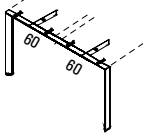
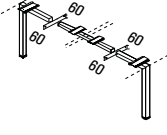
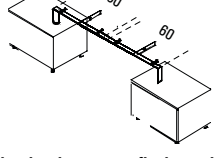
<b>GAMBE METALLICHE P.60-125</b> <i>METAL LEGS DEPTH 60-125</i> <b>PIETEMENTS METALLIQUES P.60-125</b>	<b>CODICE</b> <i>CODE</i> <b>CODE</b>		<b>FIN. GAMBE</b> <i>LEG FINISHING</i> <b>FINITION PIEDS</b>	<b>L x H.</b> <i>W x H.</i> <b>L x P x H.</b>	<b>COLLI</b> <i>PACKS</i> <b>COLIS</b>	<b>VOLUMI</b> <i>VOLUME</i> <b>VOLUME</b>	<b>PESO</b> <i>WEIGHT</i> <b>POIDS</b>	<b>PREZZO</b> <i>PRICE</i> <b>PRIX</b> <b>€</b>
 <p><b>Gamba metallica finale piani Prof.60</b> <i>Final metal leg for desktops depth 60</i> <i>Pied métallique pour plans prof. 60</i></p>	<b>SOR011F</b>		AL	60 x 69,5	1	0,073	5,8	<b>144,00</b>
			BI					
 <p><b>Coppia gambe metalliche finali per piani P.60</b> <i>Two final metal legs for desktops depth 60</i> <i>Jeu de pieds métalliques pour plans prof. 60</i></p>	<b>SOR012F</b>		AL	60 x 69,5	1	0,073	10,2	<b>277,00</b>
			BI					
 <p><b>Gamba metallica centrale "QUADRATA" per 2 piani P.60</b> <i>Central "SQUARE" metal leg for 2 desktops depth 60</i> <i>Pied métallique "CARRE" centrale pour 2 plans prof. 60</i></p>	<b>SQQ013C</b>		NR	60 x 69,5	1	0,034	6,0	<b>98,00</b>
			BI					
 <p><b>Gamba metallica doppia finale 1/2 piani Prof.60/125</b> <i>Final double metal leg for 1/2 desktops depth 60/125</i> <i>Pied double métallique pour 1/2 plans prof. 60/125</i></p>	<b>SOR016F</b>		NR	125 x 69,5	2	0,027	7,9	<b>221,00</b>
			BI					
 <p><b>Gamba metallica doppia centrale "QUADRATA" 2/4 piani Prof.60/125</b> <i>Central "SQUARE" double metal leg for desktops depth 60/125</i> <i>Pied double métallique à "CARRE" pour 2/4 plans prof. 60/125</i></p>	<b>SQQ016C</b>		NR	125 x 69,5	2	0,041	8,7	<b>146,00</b>
			BI					
 <p><b>Gamba metallica doppia portante finale per 1/2 piani prof. 60/125</b> <i>Load bearing final metal leg for 1/2 desktops depth 60/125</i> <i>Pied métallique porteur finale pour 1/2 plans prof. 60/125</i></p>	<b>SOR017F</b>		NR	125 x 69,5	2	0,023	6,0	<b>278,00</b>
			BI					



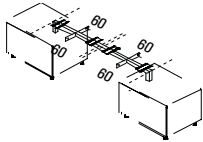
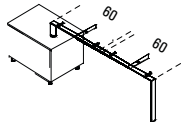
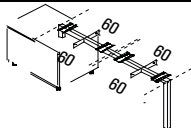
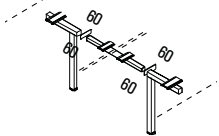

# TRILOGY

<b>GAMBE METALLICHE P.125</b> <b>METAL LEGS DEPTH 125</b> <b>PIETEMENTS METALLIQUES P.125</b>	<b>CODICE</b> <b>CODE</b> <b>CODE</b>		<b>FIN. GAMBE</b> <b>LEG FINISHING</b> <b>FINITION PIEDS</b>	<b>L x H.</b> <b>W x H.</b> <b>L x P x H.</b>	<b>COLLI</b> <b>PACKS</b> <b>COLIS</b>	<b>VOLUMI</b> <b>VOLUME</b> <b>VOLUME</b>	<b>PESO</b> <b>WEIGHT</b> <b>POIDS</b>	<b>PREZZO</b> <b>PRICE</b> <b>PRIX</b> <b>€</b>
 <p><b>Gamba metallica doppia centrale "QUADRATA" per 2/4 piani P.60/125</b> <i>Central "SQUARE" double metal leg for 2/4 desktops depth 60/125</i> <b>Pied métallique porteur double à "CARRE" finale pour 2/4 plans prof.60/125</b></p>	<b>SQ0017C</b>		<b>AL</b> <b>BI</b> <b>NR</b>	125 x 69,5	2	0,041	8,7	<b>199,00</b>
			<b>CR</b>					<b>394,00</b>
 <p><b>Gamba metallica portante finale per 1/2 piani prof. 60/125</b> <i>Load bearing final metal leg for 1/2 desktops depth 60/125</i> <b>Pied métallique porteur finale pour 1/2plans prof.60/125</b></p>	<b>SOR018F</b> <b>DX-SX</b>		<b>AL</b> <b>BI</b> <b>NR</b>	125 x 69,5	2	0,049	8,0	<b>175,00</b>
			<b>CR</b>					<b>367,00</b>
 <p><b>Gamba metallica portante doppia centrale QUADRATA per 2/4 piani P.60/125</b> <i>Load bearing central "SQUARE" double metal leg for 2/4 desktops depth 60/125</i> <b>Pied métallique porteur double à "CARRE" centrale pour 2/4 plans prof.60/125</b></p>	<b>SQ0018C</b>		<b>AL</b> <b>BI</b> <b>NR</b>	125 x 69,5	2	0,050	9,2	<b>175,00</b>
			<b>CR</b>					<b>367,00</b>
 <p><b>Gamba metallica rientrata doppia finale/centrale "QUADRATA" per 2/4 piani prof.60/125</b> <i>Double inner final/central "SQUARE" metal leg for 2/4 plans depth 60/125</i> <b>Pied métallique double rentré finale/centrale "CARRE" pour 2/4 plans prof.60/125</b></p>	<b>SQ0019C</b>		<b>AL</b> <b>BI</b> <b>NR</b>	105 x 69,5	2	0,050	9,2	<b>151,00</b>
			<b>CR</b>					<b>381,00</b>

# TRILOGY

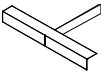
Disponibili in altre finiture: STAFFA e TRAVERSINO (BI-NR); TRAVE (BI-NR-CR). PREZZI DA CALCOLARE  
 Other finishes available for : BRACKET and HOLDING BRACKET (BI-NR); BEAM (BI-NR-CR). PRICES TO BE MADE  
 Des autres finitions pour: ETRIER et ETRIER de SOUTIEN (BI-NR); POUTRE (BI-NR-CR). PRIX A CALCULER

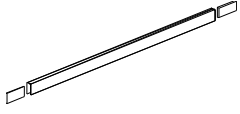

COMPONENTI METALLICI METAL COMPOUNDS COMPOSANTS METALLIQUES	CODICE CODE CODE		FIN. GAMBE LEG FINISHING FINITION PIEDS	L x H. W x H. L x P x H.	COLLI PACKS COLIS	VOLUMI VOLUME VOLUME	PESO WEIGHT POIDS	PREZZO PRICE PRIX €
 <p><b>Staffa aggancio trave per pannelli e cassettiere</b>                      Bracket for beam hooking for panels and drawers  <i>Etrier accrochement poutre pour panneaux et caissons</i></p>	S0020		AL		1	0,031	1,9	46,00
 <p><b>Traversino per gambe singole o per terminali</b>                      Holding bracket for single legs and terminal edges  <i>Etrier de soutien pour pied single ou plans terminales</i></p>	S0022		AL		1	0,000	0,4	16,00
 <p><b>Travi metalliche per piani di lavoro</b>                      Metal beams for working desktops  <i>Poutres métalliques pour plans de travail</i></p>	S0030		AL	L.80	1	0,001	1,1	20,00
	S0031		AL	L.100	1	0,002	1,5	24,00
	S0032		AL	L.120	1	0,002	1,8	27,00
	S0033		AL	L.140	1	0,002	2,1	30,00
	S0034		AL	L.160	1	0,003	2,5	34,00
	S0035		AL	L.180	1	0,003	2,9	36,00
	S0036		AL	L.200	1	0,003	3,3	39,00
	S0037		AL	L.220	1	0,004	3,7	43,00

# TRILOGY







Disponibili in altre finiture: COMPONENTI PER PIANI SCORREVOLI (BI-NR). PREZZI DA CALCOLARE

Other finishes available for : COMPOUNDS FOR SLIDING DESKS (BI-NR). PRICES TO BE MADE

Des autres finitions pour: COMPOSANTS POUR PLANS COULISSANTES(BI-NR). PRIX A CALCULER

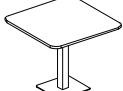
COMPONENTI METALLICI METAL COMPOUNDS COMPOSANTS METALLIQUES	CODICE CODE CODE		FIN. GAMBE LEG FINISHING FINITION PIEDS	L x H. W x H. L x P x H.	COLLI PACKS COLIS	VOLUMI VOLUME VOLUME	PESO WEIGHT POIDS	PREZZO PRICE PRIX €
 <p>H.69,5</p> <p>Gamba metallica di sostegno per scrivanie ad angolo Metal leg for angular desk <i>Pied métallique pour postes compacts</i></p>	S0040		AL BI NR	H.69,5 Diam.8	1	0,016	3,6	64,00
COMPONENTI PER PIANI SCORREVOLI METAL COMPOUNDS FOR SLIDING DESKS COMPOSANTS METALLIQUES POUR PLANS COULISSANTES	CODICE CODE CODE		FIN. GAMBE LEG FINISHING FINITION PIEDS	L x H. W x H. L x P x H.	COLLI PACKS COLIS	VOLUMI VOLUME VOLUME	PESO WEIGHT POIDS	PREZZO PRICE PRIX €
 <p>Coppia Kit terminale per N°1 scrivanie scorrevole P.80 <i>Terminal kit for 1 sliding 80 cm depth desktop</i> Jeu de kit terminale pour N°1 plan poste coulissant profondeur 80</p>	S0045		AL	L.80	1	0,003	4,2	65,00
 <p>Kit intermedio per N°2 piani scrivania scorrevoli prof.80 <i>Intermediate kit for 2 sliding 80 cm depth desktop</i> Kit intermédiaire pour N°2 plan postex coulissant profondeur 80</p>	S0046		AL	L.80	1	0,008	3,5	60,00

# TRILOGY

TAVOLI RIUNIONE MEETING TABLES TABLES DE REUNION	CODICE CODE CODE	FINITURA PIANI TOP FINISHING FIN. PLANS	FINITURA GAMBE LEG FINISHING FINITION PIEDS	L x P x H W x D x H L x P x H	COLLI PACKS COLIS	VOLUMI VOLUME VOLUME	PESO WEIGHT POIDS	PREZZO PRICE PRIX
								€
 <b>Tavolo circolare diam.90 piano legno (4 posti)</b> <i>Round meeting table D.90 with wooden top (4 seats)</i> Table de réunion ronde D.90 avec plan mélaminé (4 Places)	S0721	NCA RM RSB OL GAV GTO BI	AL	Diam.90 H.75,5	3	0,081	31,4	347,00
			XL					472,00
 <b>Tavolo circolare diam.90 piano vetro (4 posti)</b> <i>Round meeting table D.90 with glass top (4 seats)</i> Table de réunion ronde D.90 avec plan en verre (4 Places)	S0721V	VS VN VB VC VR	AL	Diam.90 H.74,2	3	0,098	39,7	741,00
			BI					866,00
			NR					899,00
			XL					1.024,00
 <b>Tavolo riunione 90x90 piano legno (4 posti)</b> <i>Meeting table 90x90 with wooden top (4 seats)</i> Table de réunion 90x90 avec plan mélaminé (4 Places)	S0721.1	NCA RM RSB OL GAV GTO BI	AL	90 x 90 x 75,5	3	0,075	33,4	374,00
			XL					511,00
 <b>Tavolo riunione 90x90 piano vetro (4 posti)</b> <i>Meeting table 90x90 with glass top (4 seats)</i> Table de réunion 90x90 avec plan en verre (4 Places)	S0721.V	VS VN VB VC VR	AL	90 x 90 x 74,2	3	0,092	41,7	768,00
			BI					905,00
			NR					926,00
			XL					1.062,00
 <b>Tavolo circolare diam.120 piano legno (4 posti)</b> <i>Round meeting table D.120 with wooden top (4 seats)</i> Table de réunion ronde D.120 avec plan mélaminé (4 Places)	S0722	NCA RM RSB OL GAV GTO BI	AL	Diam.120 H.75,5	3	0,126	56,4	560,00
			XL					590,00
 <b>Tavolo circolare diam.120 piano vetro (4 posti)</b> <i>Round meeting table D.120 with glass top (4 seats)</i> Table de réunion ronde D.120 avec plan en verre (4 Places)	S0722V	VS VN VB VC VR	AL	Diam.120 H.74,2	3	0,154	72,1	1.152,00
			BI					1.182,00
			NR					1.467,00
			XL					1.497,00

# TRILOGY

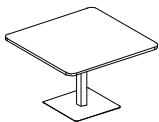
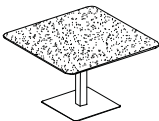
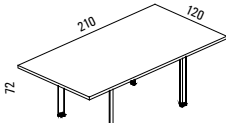
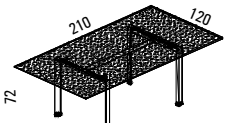
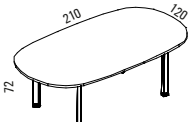
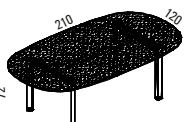
TAVOLI RIUNIONE MEETING TABLES TABLES DE REUNION	CODICE CODE CODE	FINITURA PIANI TOP FINISHING FIN. PLANS	FIN. GAMBE LEG FINISHING FINITION PIEDS	L x P x H W x D x H L x P x H	COLLI PACKS COLIS	VOLUMI VOLUME VOLUME	PESO WEIGHT POIDS	PREZZO PRICE PRIX
								€
 <p><b>Tavolo riunione 120x120 piano legno (4 posti)</b> <i>Meeting table 120x120 with wooden top (4 seats)</i> Table de réunion 120x120 avec plan mélaminé (4 Places)</p>	S0722.1	NCA RM RSB OL GAV GTO BI	AL	120 x 120 x 75,5	3	0,123	62,4	639,00
			XL					817,00
 <p><b>Tavolo circolare 120x120 piano vetro (4 posti)</b> <i>Round meeting table 120x120 with glass top (4 seats)</i> Table de réunion ronde 120x120 avec plan en verre (4 Places)</p>	S0722.1V	VS VN VB VC VR	AL	120 x 120 x 74,2	3	0,151	78,1	1.231,00
			BI					1.409,00
			NR					1.546,00
			XL					1.724,00
			CR					
 <p><b>Tavolo riunione L.210x120 piano legno (6-8 posti)</b> <i>Meeting table W.210x120 with wooden top (6-8 seats)</i> Table de réunion L.210x120 avec plan mélaminé (6-8 Places)</p>	SOR705	NCA RM RSB OL GAV GTO BI	AL	210 x 120 x 72	3	0,215	61,1	534,00
			CR					905,00
 <p><b>Tavolo riunione L.210x120 piano vetro (6-8 posti)</b> <i>Meeting table W.210x120 with glass top (6-8 seats)</i> Table de réunion L.210x120 avec plan en verre (6-8 Places)</p>	SOR705V	VS VN VB VC VR	AL	210 x 120 x 72	3	0,262	93,9	1.342,00
			BI					1.712,00
			NR					1.861,00
			CR					2.232,00
			CR					
 <p><b>Tavolo riunione L.210x120 piano legno (6-8 posti)</b> <i>Meeting table W.210x120 with wooden top (6-8 seats)</i> Table de réunion L.210x120 avec plan mélaminé (6-8 Places)</p>	SOR715	NCA RM RSB OL GAV GTO BI	AL	210 x 120 x 72	3	0,215	61,1	652,00
			CR					1.023,00
 <p><b>Tavolo riunione L.210x120 piano vetro (6-8 posti)</b> <i>Meeting table W.210x120 with glass top (6-8 seats)</i> Table de réunion L.210x120 avec plan en verre (6-8 Places)</p>	SOR715V	VS VN VB VC VR	AL	210 x 120 x 72	3	0,262	88,7	1.483,00
			BI					1.854,00
			NR					2.050,00
			CR					2.421,00
			CR					

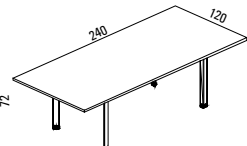
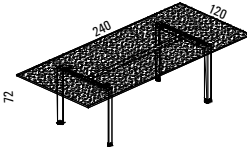
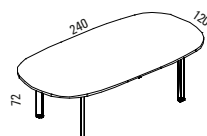
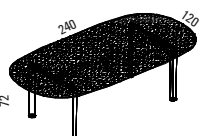
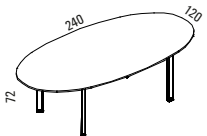
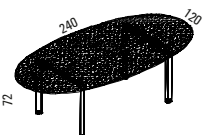

# TRILOGY

TAVOLI RIUNIONE MEETING TABLES TABLES DE REUNION	CODICE CODE CODE	FINITURA PIANI TOP FINISHING FIN. PLANS	FIN. GAMBE LEG FINISHING FINITION PIEDS	L x P x H W x D x H L x P x H	COLLI PACKS COLIS	VOLUMI VOLUME VOLUME	PESO WEIGHT POIDS	PREZZO PRICE PRIX
								€
 <p><b>Tavolo riunione L.240x120 piano legno (8 posti)</b> <i>Meeting table W.240x120 with wooden top (8 seats)</i> Table de réunion L.240x120 avec plan mélaminé (8 Places)</p>	<b>SOR706</b>	NCA RM RSB OL GAV GTO BI	AL	240 x 120 x 72	3	0,233	68,7	571,00
			CR					942,00
 <p><b>Tavolo riunione L.240x120 piano vetro (8 posti)</b> <i>Meeting table W.240x120 with glass top (8 seats)</i> Table de réunion L.240x120 avec plan en verre (8 Places)</p>	<b>SOR706V</b>	VS VN VB VC VR	AL	240 x 120 x 72	3	0,286	106,1	1.467,00
			BI					1.837,00
			NR					2.128,00
			CR					2.499,00
 <p><b>Tavolo riunione L.240x120 piano legno (8 posti)</b> <i>Meeting table W.240x120 with wooden top (8 seats)</i> Table de réunion L.240x120 avec plan mélaminé (8 Places)</p>	<b>SOR716</b>	NCA RM RSB OL GAV GTO BI	AL	240 x 120 x 72	3	0,233	68,7	689,00
			CR					1.060,00
 <p><b>Tavolo riunione L.240x120 piano vetro (8 posti)</b> <i>Meeting table W.240x120 with glass top (8 seats)</i> Table de réunion L.240x120 avec plan en verre (8 Places)</p>	<b>SOR716V</b>	VS VN VB VC VR	AL	240 x 120 x 72	3	0,286	100,4	1.632,00
			BI					2.003,00
			NR					2.294,00
			CR					2.664,00
 <p><b>Tavolo riunione ellittico L.240 piano legno (8 posti)</b> <i>Elliptical meeting table W.240 with wooden top (8 seats)</i> Table de réunion elliptique L.240 avec plan mélaminé (8 Places)</p>	<b>SOR717</b>	NCA RM RSB OL GAV GTO BI	AL	240 x 120 x 72	3	0,233	68,7	689,00
			CR					1.060,00
 <p><b>Tavolo riunione ellittico L.240 piano vetro (8 posti)</b> <i>Elliptical meeting table W.240 with glass top (8 seats)</i> Table de réunion elliptique L.240 avec plan en verre (8 Places)</p>	<b>SOR717V</b>	VS VN VB VC VR	AL	240 x 120 x 72	3	0,286	100,4	1.632,00
			BI					2.003,00
			NR					2.294,00
			CR					2.664,00

**TRILOGY**



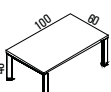
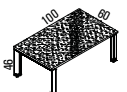
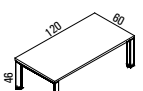
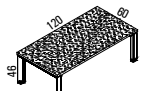

**COMPOSIZIONI**

# TRILOGY

TAVOLI CAFFÈ COFFEE TABLES TABLES À CAFÈ	CODICE CODE CODE	FINITURA PIANI TOP FINISHING FIN. PLANS	FIN. GAMBE LEG FINISHING FINITION PIEDS	L x P x H W x D x H L x P x H	COLLI PACKS COLIS	VOLUMI VOLUME VOLUME	PESO WEIGHT POIDS	PREZZO PRICE PRIX		
								€		
 <b>Tavolo caffè piano legno</b> <i>Coffee table with wooden top</i> Table à café avec plan mélaminé	SOR780	NCA RM RSB OL GAV GTO BI	AL	60 x 60 H.46	3	0,061	11,4	334,00		
			BI					NR	CR	613,00
 <b>Tavolo caffè piano vetro</b> <i>Coffee table with glass top</i> Table à café avec plan en verre	SOR780V	VS VN VB VC VR	AL	60 x 60 H.46	3	0,069	16,1	494,00		
			BI					NR	CR	774,00
			AL					BI	NR	575,00
			VC					NR	CR	855,00
			VR					CR		
 <b>Tavolo caffè piano legno</b> <i>Coffee table with wooden top</i> Table à café avec plan mélaminé	SOR781	NCA RM RSB OL GAV GTO BI	AL	100 x 60 H.46	3	0,072	16,7	357,00		
			BI					NR	CR	636,00
 <b>Tavolo caffè piano vetro</b> <i>Coffee table with glass top</i> Table à café avec plan en verre	SOR781V	VS VN VB VC VR	AL	100 x 60 H.46	3	0,086	24,5	579,00		
			BI					NR	CR	859,00
			AL					BI	NR	714,00
			VC					NR	CR	994,00
			VR					CR		
 <b>Tavolo caffè piano legno</b> <i>Coffee table with wooden top</i> Table à café avec plan mélaminé	SOR782	NCA RM RSB OL GAV GTO BI	AL	120 x 60 H.46	3	0,078	19,3	369,00		
			BI					NR	CR	649,00
 <b>Tavolo caffè piano vetro</b> <i>Coffee table with glass top</i> Table à café avec plan en verre	SOR782V	VS VN VB VC VR	AL	120 x 60 H.46	3	0,094	28,6	618,00		
			BI					NR	CR	898,00
			AL					BI	NR	762,00
			VC					NR	CR	1.042,00
			VR					CR		



# TRILOGY

TAVOLI CAFFÈ COFFEE TABLES TABLES À CAFÉ	CODICE CODE CODE	FINITURA PIANI TOP FINISHING FIN. PLANS	FINITURA GAMBE LEG FINISHING FINITION PIEDS	L x P x H W x D x H L x P x H	COLLI PACKS COLIS	VOLUMI VOLUME VOLUME	PESO WEIGHT POIDS	PREZZO PRICE PRIX
								€
 <p><b>Tavolo caffè circolare piano legno diam.60</b> <i>Round coffee table with wooden top diameter 60</i> Table à café ronde avec plan mélaminé diamètre 60</p>	<b>S0783</b>	NCA RM RSB OL GAV GTO BI	AL	Diam.60 H.52,5	3	0,044	21,3	<b>320,00</b>
			XL					<b>435,00</b>
 <p><b>Tavolo caffè circolare piano vetro diam.60</b> <i>Round coffee table with glass top diameter 60</i> Table à café ronde avec plan en verre diamètre 60</p>	<b>S0783V</b>	VS VN VB VC VR	AL	Diam.60 H.51,2	3	0,053	24,5	<b>592,00</b>
			BI					<b>707,00</b>
			NR					<b>660,00</b>
			XL					<b>775,00</b>
			XL					<b>775,00</b>
 <p><b>Tavolo caffè 60x60 piano legno</b> <i>Coffee table 60x60 with wooden top</i> Table à café 60x60 avec plan mélaminé</p>	<b>S0783.1</b>	NCA RM RSB OL GAV GTO BI	AL	60 x 60 x 52,5	3	0,052	22,8	<b>324,00</b>
			XL					<b>448,00</b>
 <p><b>Tavolo caffè 60x60 piano vetro</b> <i>Coffee table 60x60 with glass top</i> Table à café 60x60 avec plan en verre</p>	<b>S0783.1V</b>	VS VN VB VC VR	AL	60 x 60 x 51,2	3	0,061	26,0	<b>596,00</b>
			BI					<b>721,00</b>
			NR					<b>663,00</b>
			XL					<b>788,00</b>
			XL					<b>788,00</b>



# STUDIOFFICE

## QUADRA

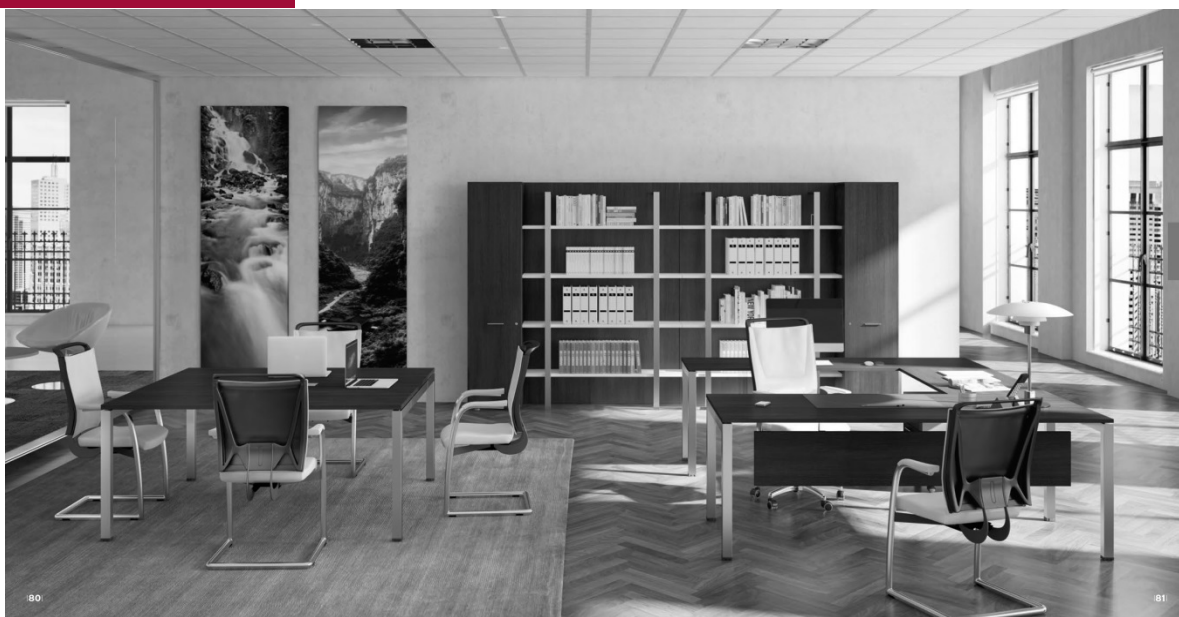

### STRUTTURE SCRIVANIE

Gambe metalliche sezione quadrata: disponibili nelle profondità L.60 / 80 / 125 / 165 cm, sono realizzate in tubolare metallico trafilato a sezione quadrata verniciate a polveri epossidiche nei colori, alluminio, nero lucido, bianco o cromato e dotate di piedino livellatore. Nella parte trasversale superiore sono predisposti agganci per il fissaggio della trave portante.

Le travi portanti sono realizzate in tubolare metallico trafilato a sezione rettangolare, verniciate a polveri epossidiche nel colore alluminio.

Opzionale, è disponibile il sistema "SLIDING" che permette di far scorrere il piano in orizzontale sulla struttura metallica in modo da accedere e ispezionare facilmente la parte inferiore nella quale viene posizionata la vaschetta per raccogliere i cavi in eccedenza.

### DESKS STRUCTURES

Bridge square metal structures are available in depth L.60 / 80 / 125 / 165 cm. Structures are made of steel square section, varnished with epossidic paint in aluminium, gloss black and white colours, or chromed, with levelling feet. In the basement upper section there are hooks for load bearing beam fixing. Load bearing beams are made of rectangular section steel, varnished with aluminium epossidic paints.

It is also available the "SLIDING" version that allows the horizontal desktop to slide on the metallic structure so that the lower part can be inspectionable for the placement of exceeding wire management box.

### STRUCTURES DES BUREAUX

Pieds métal section carree disponibles dans les profondeurs L.60 ou 80/125/165 cm, faits de métal tubulaire à section carrée vernis de résine époxyde aluminium, noir brillant, blanc ou chromé. Ils sont équipés de verins de réglage. Dans la pièce transversale supérieure sont disposés des crochets de fixation de la poutre.

Les poutres porteuses sont en acier tubulaire à section rectangulaire extrudée, vernis de résine époxy, couleur aluminium.

En option, il y a le système coulissant qui vous permet de faire défiler horizontalement le plan sur la structure métallique afin d'accéder facilement et inspecter la partie inférieure dans laquelle il y a la poche pour les câblages en excès.

01	<b>BI</b> Bianco White Blanc	02	<b>AL</b> Alluminio Aluminium Aluminium	04	<b>NR</b> Nero lucido Gloss black Noir brillant	05	<b>CR</b> Cromato Chrome Chrome
----	---------------------------------------	----	--	----	--	----	--

\*QUADRA può essere completato con cassettiere, mobili di servizio, contenitori ed accessori consultabili nelle rispettive sezioni da pag. 141 a seguire.

\*QUADRA can be completed with drawers, service cabinets, cabinets and accessories to be found in the respective sections from page 141 on

\*QUADRA peut être complété avec caissons mobiles, des meubles de service, des armoires et accessoires disponibles dans les sections correspondantes à partir de la page 141 à suivre

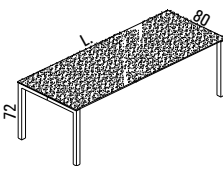
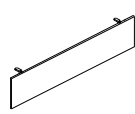
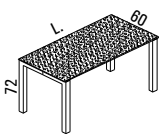

# QUADRA

SCRIVANIE DIREZIONALI EXECUTIVE DESKS POSTE DIRECTION	CODICE CODE CODE	FINITURA PIANI TOP FINISHING FIN. PLANS	FIN. GAMBE LEG FINISHING FINITION PIEDS	L x P x H W x D x H L x P x H	COLLI PACKS COLIS	VOLUMI VOLUME VOLUME	PESO WEIGHT POIDS	PREZZO PRICE PRIX		
								€		
 <p><b>Scrivania piano vetro</b> <i>Desk with glass top</i> Poste avec plan en verre</p>	SOQ305V	VS	AL	180 x 80 x 73	3	0,196	60,4	839,00		
			BI					1.274,00		
		NR	1.064,00							
		CR	1.499,00							
	SOQ306V	VN	VS	AL	200 x 80 x 73	3	0,207	66,0	887,00	
				BI					1.322,00	
		NR	1.135,00							
		CR	1.569,00							
	 <p><b>Modesty panel per scrivanie vetro</b> <i>Modesty panel for glass desks</i> Voile de fond pour plan en verre</p>	SO605V	NCA	Per SOQ305V For SOQ305V POUR SOQ305V	L.168 x H.28,4	1	0,020	7,5	63,00	
		SO606V	RSB	Per SOQ306V For SOQ306V POUR SOQ306V	L.188 x H.28,4	1	0,023	8,3	67,00	
			OL							
			GAV							
		GTO								
		BI								
 <p><b>Allungo laterale o frontale per piani vetro</b> <i>Lateral or frontal extension for glass desks</i> Extension laterale et frontale pour poste en verre</p>	SOQ311V	VS	AL	80 x 60 x 72	3	0,108	26,5	434,00		
			BI					812,00		
		NR	524,00							
		CR	902,00							
	SOQ312V	VN	VS	AL	90 x 60 x 72	3	0,112	28,4	457,00	
				BI					835,00	
		NR	569,00							
		CR	947,00							
	SOQ314V	VN	VS	AL	120 x 60 x 72	3	0,125	34,5	519,00	
				BI					897,00	
		NR	663,00							
		CR	1.041,00							

# QUADRA

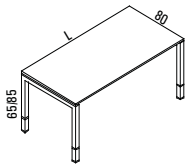
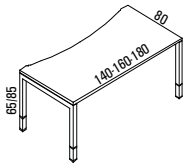
SCRIVANIE OPERATIVE REGOLABILI OPERATIVE ADJUSTABLE DESKS BUREAUX OPÉRATIONNELS RÉGLABLES	CODICE CODE CODE	FINITURA PIANI TOP FINISHING FIN. PLANS	FIN. GAMBE LEG FINISHING FINITION PIEDS	L x P x H W x D x H L x P x H	COLLI PACKS COLIS	VOLUMI VOLUME VOLUME	PESO WEIGHT POIDS	PREZZO PRICE PRIX		
								€		
 <p><b>H.65/85</b></p> <p>Scrivania con gambe <b>REGOLABILI</b>, profondità <b>cm.80</b> Desk with <b>ADJUSTABLE</b> legs, depth <b>cm.80</b> <i>Poste pieds <b>REGLABLES</b> profondeur <b>cm.80</b></i></p>	<b>SOQ300R</b>	<b>NCA RM RSB OL GAV GTO BI</b>	<b>AL</b>	<b>80 x 80 x 65/85</b>	<b>3</b>	<b>0,129</b>	<b>28,0</b>	<b>438,00</b>		
			<b>BI</b>							
			<b>NR</b>							
			<b>SOQ302R</b>		<b>AL</b>	<b>120 x 80 x 65/85</b>	<b>3</b>	<b>0,144</b>	<b>34,7</b>	<b>470,00</b>
			<b>BI</b>							
			<b>NR</b>							
			<b>SOQ303R</b>		<b>AL</b>	<b>140 x 80 x 65/85</b>	<b>3</b>	<b>0,152</b>	<b>38,1</b>	<b>486,00</b>
			<b>BI</b>							
			<b>NR</b>							
			<b>SOQ304R</b>		<b>AL</b>	<b>160 x 80 x 65/85</b>	<b>3</b>	<b>0,160</b>	<b>41,5</b>	<b>502,00</b>
			<b>BI</b>							
			<b>NR</b>							
	<b>SOQ305R</b>		<b>AL</b>	<b>180 x 80 x 65/85</b>	<b>3</b>	<b>0,167</b>	<b>44,9</b>	<b>517,00</b>		
	<b>BI</b>									
	<b>NR</b>									
	<b>SOQ306</b>		<b>AL</b>	<b>200 x 80 x 65/85</b>	<b>3</b>	<b>0,175</b>	<b>48,4</b>	<b>533,00</b>		
	<b>BI</b>									
	<b>NR</b>									
 <p><b>H.65/85</b></p> <p>Scrivania sagomata con gambe <b>REGOLABILI</b>, profondità <b>cm.80</b> Shaped desk with <b>ADJUSTABLE</b> legs, depth <b>cm.80</b> <i>Poste plan double vague pieds <b>REGLABLES</b> profondeur <b>cm.80</b></i></p>	<b>SOQ320R</b>	<b>NCA RM RSB OL GAV GTO BI</b>	<b>AL</b>	<b>140 x 80 x 65/85</b>	<b>3</b>	<b>0,152</b>	<b>38,1</b>	<b>537,00</b>		
			<b>BI</b>							
			<b>NR</b>							
			<b>SOQ321R</b>		<b>AL</b>	<b>160 x 80 x 65/85</b>	<b>3</b>	<b>0,160</b>	<b>41,5</b>	<b>553,00</b>
			<b>BI</b>							
			<b>NR</b>							
			<b>SOQ322R</b>		<b>AL</b>	<b>180 x 80 x 65/85</b>	<b>3</b>	<b>0,167</b>	<b>44,9</b>	<b>569,00</b>
			<b>BI</b>							
			<b>NR</b>							

# QUADRA

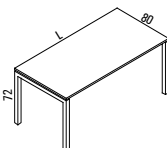
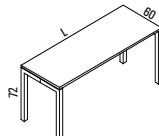
SCRIVANIE OPERATIVE OPERATIVE DESKS BUREAUX OPÉRATIONNELS	CODICE CODE CODE	FINITURA PIANI TOP FINISHING FIN. PLANS	FINITURA GAMBE LEG FINISHING FINITION PIEDS	L x P x H W x D x H L x P x H	COLLI PACKS COLIS	VOLUMI VOLUME VOLUME	PESO WEIGHT POIDS	PREZZO PRICE PRIX
								€
 <p>Scrivania profondità cm.80 Desk depth cm.80 Poste profondeur cm.80</p>	S00300	NCA RM RSB OL GAV GTO BI	AL	80 x 80 x 72	3	0,1286	24,8	266,00
			BI					
			NR					
	S00302		AL	120 x 80 x 72	3	0,1441	31,5	298,00
			BI					
			NR					
S00303	AL		140 x 80 x 72	3	0,1518	34,9	314,00	
	BI							
	NR							
S00304	AL	160 x 80 x 72	3	0,1596	38,3	330,00		
	BI							
	NR							
S00305	AL	180 x 80 x 72	3	0,1673	41,7	345,00		
	BI							
	NR							
S00306	AL	200 x 80 x 72	3	0,175	45,2	361,00		
	BI							
	NR							
 <p>Scrivania profondità cm.60 Desk depth cm.60 Poste profondeur cm.60</p>	S00311	AL	80 x 60 x 72	3	0,0973	20,2	247,00	
		BI						
		NR						
	S00313	AL	100 x 60 x 72	3	0,1032	22,9	260,00	
		BI						
		NR						
	S00314	AL	120 x 60 x 72	3	0,1091	25,5	273,00	
		BI						
		NR						
	S00315	AL	140 x 60 x 72	3	0,1151	28,1	285,00	
		BI						
		NR						
S00316	AL	160 x 60 x 72	3	0,121	30,7	299,00		
	BI							
	NR							
S00317	AL	180 x 60 x 72	3	0,1433	40,2	311,00		
	BI							
	NR							
S00318	AL	200 x 60 x 72	3	0,151	43,7	323,00		
	BI							
	NR							

# QUADRA

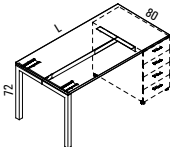
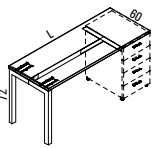
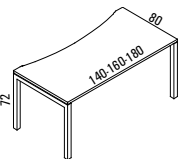
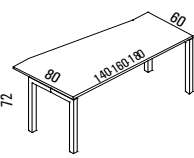
SCRIVANIE OPERATIVE OPERATIVE DESKS BUREAUX OPÉRATIONNELS	CODICE CODE CODE	FINITURA PIANI TOP FINISHING FIN. PLANS	FINITURA GAMBE LEG FINISHING FINITION PIEDS	L x P x H W x D x H L x P x H	COLLI PACKS COLIS	VOLUMI VOLUME VOLUME	PESO WEIGHT POIDS	PREZZO PRICE PRIX								
								€								
 <p><b>DX</b></p> <p><b>Scrivania portante profondità cm.80</b> Load bearing desk depth cm.80 <i>Poste porteur profondeur cm.80</i></p>	<b>S0Q303S DX-SX</b>	NCA RM OL RSB GAV GTO BI	AL BI NR	140 x 80 x 72	4	0,1818	30,9	<b>258,00</b>								
	<b>S0Q304S DX-SX</b>		AL BI NR					160 x 80 x 72	4	0,1895	34,3	<b>274,00</b>				
	<b>S0Q305S DX-SX</b>		AL BI NR									180 x 80 x 72	4	0,1973	37,6	<b>290,00</b>
	<b>S0Q306S DX-SX</b>		AL BI NR													200 x 80 x 72
 <p><b>DX</b></p> <p><b>Scrivania portante profondità cm.60</b> Load bearing desk depth cm.60 <i>Poste porteur profondeur cm.60</i></p>	<b>S0Q315S DX-SX</b>	NCA RM RSB OL GAV GTO BI	AL BI NR	140 x 80 x 72	4	0,145	24,8									
	<b>S0Q316S DX-SX</b>		AL BI NR					160 x 80 x 72	4	0,151	27,4					
	<b>S0Q317S DX-SX</b>		AL BI NR									180 x 80 x 72	4	0,1569	30,0	
	<b>S0Q318S DX-SX</b>		AL BI NR													200 x 80 x 72
 <p><b>Scrivania sagomata profondità cm.80</b> Shaped desk depth cm.80 <i>Poste double vague profondeur cm.80</i></p>	<b>S0Q320</b>	NCA RM RSB OL GAV GTO BI	AL BI NR	140 x 80 x 72	3	0,152	34,9									
	<b>S0Q321</b>		AL BI NR					160 x 80 x 72	3	0,160	38,3					
	<b>S0Q322</b>		AL BI NR									180 x 80 x 72	3	0,167	41,7	
 <p><b>DX</b></p> <p><b>Scrivania sagomata profondità cm.60/80</b> Shaped desk depth cm.60/80 <i>Poste vague profondeur cm.60/80</i></p>	<b>S0Q325 DX-SX</b>	NCA RM RSB OL GAV GTO BI	AL BI NR	140 x 60/80 x 72	3	0,128	33,4									<b>358,00</b>
	<b>S0Q326 DX-SX</b>		AL BI NR					160 x 60/80 x 72	3	0,136	36,8					<b>375,00</b>
	<b>S0Q327 DX-SX</b>		AL BI NR									180 x 60/80 x 72	3	0,143	40,2	<b>390,00</b>

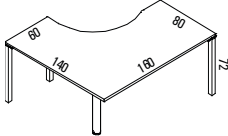
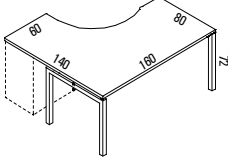
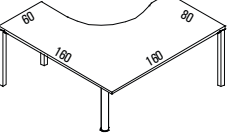
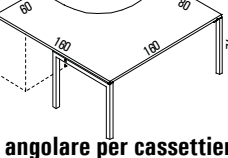
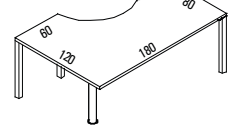
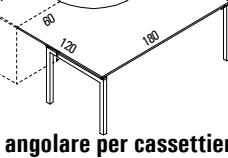

# QUADRA

<b>SCRIVANIE OPERATIVE</b> <b>OPERATIVE DESKS</b> <b>BUREAUX OPÉRATIONNELS</b>	<b>CODICE</b> <b>CODE</b> <b>CODE</b>	<b>FINITURA</b> <b>PIANI</b> <small>TOP FINISHING</small> <small>FIN. PLANS</small>	<b>FINITURA</b> <b>GAMBE</b> <small>LEG FINISHING</small> <small>FINITION PIEDS</small>	<b>L x P x H</b> <b>W x D x H</b> <b>L x P x H</b>	<b>COLLI</b> <b>PACKS</b> <b>COLIS</b>	<b>VOLUMI</b> <b>VOLUME</b> <b>VOLUME</b>	<b>PESO</b> <b>WEIGHT</b> <b>POIDS</b>	<b>PREZZO</b> <b>PRICE</b> <b>PRIX</b> <b>€</b>
 <p><b>DX</b></p> <p><b>Scrivania angolare</b> Workstation <i>Poste plan compact</i></p>	<b>S0Q330</b> <b>DX-SX</b>	<b>NCA</b> <b>RM</b> <b>RSB</b> <b>OL</b> <b>GAV</b> <b>GTO</b> <b>BI</b>	<b>AL</b> <b>BI</b> <b>NR</b>	160 x 140 x 72	6	0,293	60,9	<b>549,00</b>
 <p><b>DX</b></p> <p><b>Scrivania angolare per cassetiera portante</b> Workstation for load bearing drawer pedestal <i>Poste plan compact pour hauteur bureau</i></p>	<b>S0Q330P</b> <b>DX-SX</b>	<b>NCA</b> <b>RM</b> <b>RSB</b> <b>OL</b> <b>GAV</b> <b>GTO</b> <b>BI</b>	<b>AL</b> <b>BI</b> <b>NR</b>	160 x 140 x 72	3	0,203	56,6	<b>470,00</b>
 <p><b>DX</b></p> <p><b>Scrivania angolare</b> Workstation <i>Poste plan compact</i></p>	<b>S0Q331</b> <b>DX-SX</b>	<b>NCA</b> <b>RM</b> <b>RSB</b> <b>OL</b> <b>GAV</b> <b>GTO</b> <b>BI</b>	<b>AL</b> <b>BI</b> <b>NR</b>	160 x 160 x 72	6	0,308	67,6	<b>580,00</b>
 <p><b>DX</b></p> <p><b>Scrivania angolare per cassetiera portante</b> Workstation for load bearing drawer pedestal <i>Poste plan compact pour hauteur bureau</i></p>	<b>S0Q331P</b> <b>DX-SX</b>	<b>NCA</b> <b>RM</b> <b>RSB</b> <b>OL</b> <b>GAV</b> <b>GTO</b> <b>BI</b>	<b>AL</b> <b>BI</b> <b>NR</b>	160 x 160 x 72	3	0,218	62,6	<b>495,00</b>
 <p><b>DX</b></p> <p><b>Scrivania angolare</b> Workstation <i>Poste plan compact</i></p>	<b>S0Q332</b> <b>DX-SX</b>	<b>NCA</b> <b>RM</b> <b>RSB</b> <b>OL</b> <b>GAV</b> <b>GTO</b> <b>BI</b>	<b>AL</b> <b>BI</b> <b>NR</b>	180 x 120 x 72	6	0,290	59,6	<b>545,00</b>
 <p><b>DX</b></p> <p><b>Scrivania angolare per cassetiera portante</b> Workstation for load bearing drawer pedestal <i>Poste plan compact pour hauteur bureau</i></p>	<b>S0Q332P</b> <b>DX-SX</b>	<b>NCA</b> <b>RM</b> <b>RSB</b> <b>OL</b> <b>GAV</b> <b>GTO</b> <b>BI</b>	<b>AL</b> <b>BI</b> <b>NR</b>	180 x 120 x 72	3	0,200	55,4	<b>466,00</b>

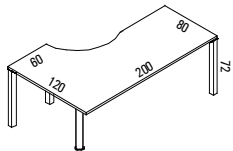
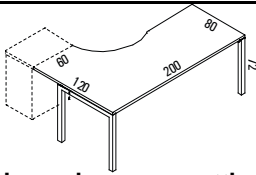
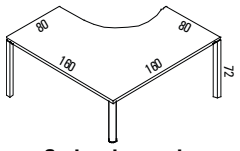
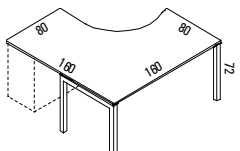

# QUADRA

SCRIVANIE OPERATIVE OPERATIVE DESKS BUREAUX OPÉRATIONNELS	CODICE CODE CODE	FINITURA PIANI TOP FINISHING FIN. PLANS	FINITURA GAMBE LEG FINISHING FINITION PIEDS	L x P x H W x D x H L x P x H	COLLI PACKS COLIS	VOLUMI VOLUME VOLUME	PESO WEIGHT POIDS	PREZZO PRICE PRIX €
 <p><b>DX</b></p> <p><b>SOQ334 DX-SX</b></p> <p><b>Scrivania angolare</b> Workstation <i>Poste plan compact</i></p>		NCA RM RSB OL GAV GTO BI	AL BI NR	200 x 120 x 72	6	0,301	64,6	<b>568,00</b>
 <p><b>DX</b></p> <p><b>SOQ334P DX-SX</b></p> <p><b>Scrivania angolare per cassetiera portante</b> Workstation for load bearing drawer pedestal <i>Poste plan compact pour hauteur bureau</i></p>		NCA RM RSB OL GAV GTO BI	AL BI NR	200 x 120 x 72	3	0,211	60,4	<b>488,00</b>
 <p><b>DX</b></p> <p><b>SOQ333 DX-SX</b></p> <p><b>Scrivania angolare</b> Workstation <i>Poste plan compact</i></p>		NCA RM RSB OL GAV GTO BI	AL BI NR	160 x 160 x 72	5	0,236	67,6	<b>581,00</b>
 <p><b>DX</b></p> <p><b>SOQ333P DX-SX</b></p> <p><b>Scrivania angolare per cassetiera portante</b> Workstation for load bearing drawer pedestal <i>Poste plan compact pour hauteur bureau</i></p>		NCA RM RSB OL GAV GTO BI	AL BI NR	160 x 160 x 72	3	0,218	62,6	<b>495,00</b>

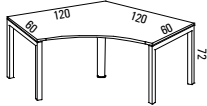
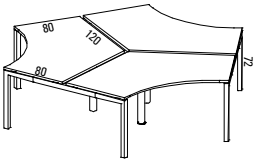
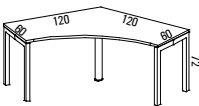
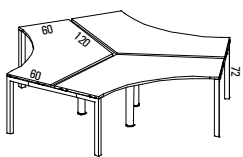

# QUADRA

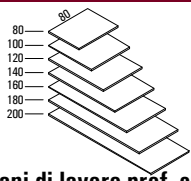
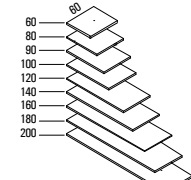
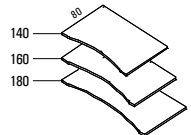
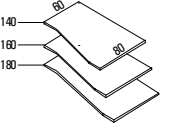
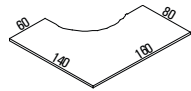
SCRIVANIE OPERATIVE OPERATIVE DESKS BUREAUX OPÉRATIONNELS	CODICE CODE CODE	FINITURA PIANI TOP FINISHING FIN. PLANS	FINITURA GAMBE LEG FINISHING FINITION PIEDS	L x P x H W x D x H L x P x H	COLLI PACKS COLIS	VOLUMI VOLUME VOLUME	PESO WEIGHT POIDS	PREZZO PRICE PRIX €
 <p><b>Scrivania angolare 120° P.80</b> Workstation 120° D.80 <i>Poste plan compact symétrique 120° P.80</i></p>	<b>S00335</b>	NCA RM RSB OL GAV GTO BI	AL BI NR	208 x 130 x 72	5	0,242	63,4	<b>585,00</b>
 <p><b>N°3 scrivanie angolari 120° P.80/165</b> N°3 workstation 120° D.80/165 <i>N°3 postes plans compacts symétriques 120° P.80/165</i></p>	<b>S00335.1</b>	NCA RM RSB OL GAV GTO BI	AL BI NR	293 x 254 x 72	18	0,584	184,5	<b>1.628,00</b>
 <p><b>Scrivania angolare 120° P.60</b> Workstation 120° D.60 <i>Poste plan compact symétrique 120° P.60</i></p>	<b>S00336</b>	NCA RM RSB OL GAV GTO BI	AL BI NR	208 x 112 x 72	5	0,203	68,1	<b>552,00</b>
 <p><b>N°3 scrivanie angolari 120° P.60/125</b> N°3 workstation 120° D.60/125 <i>N°3 postes plans compacts symétriques 120° P.60/125</i></p>	<b>S00336.1</b>	NCA RM RSB OL GAV GTO BI	AL BI NR	273 x 237 x 72	18	0,515	200,3	<b>1.021,00</b>

# QUADRA

PIANI DI LAVORO OPERATIVE DESKS BUREAUX OPÉRATIONNELS	CODICE CODE CODE	FINITURA PIANI TOP FINISHING FIN. PLANS	L x P x SP. W x D x TH. L x P x EP.	COLLI PACKS COLIS	VOLUMI VOLUME VOLUME	PESO WEIGHT POIDS	PREZZO PRICE PRIX	
							€	
 <p><b>Piani di lavoro prof. cm.80</b> Desktop depth cm.80 <i>Plan de travail cm.80</i></p>	<b>S0300</b>	<b>NCA</b>	80 x 80 x 2,5	1	0,030	12,2	<b>51,00</b>	
	<b>S0301</b>	<b>RM</b>	100 x 80 x 2,5	1	0,038	15,2	<b>64,00</b>	
	<b>S0302</b>	<b>RSB</b>	120 x 80 x 2,5	1	0,045	18,2	<b>76,00</b>	
	<b>S0303</b>	<b>OL</b>	140 x 80 x 2,5	1	0,052	21,3	<b>89,00</b>	
	<b>S0304</b>	<b>GAV</b>	160 x 80 x 2,5	1	0,060	24,3	<b>101,00</b>	
	<b>S0305</b>	<b>GTO</b>	180 x 80 x 2,5	1	0,067	27,4	<b>114,00</b>	
	<b>S0306</b>	<b>BI</b>	200 x 80 x 2,5	1	0,075	30,4	<b>127,00</b>	
 <p><b>Piani di lavoro prof. cm.60</b> Desktop depth cm.80 <i>Plan de travail profondeur cm.80</i></p>	<b>S0310</b>		60 x 60 x 2,5	1	0,017	6,8	<b>29,00</b>	
	<b>S0311</b>	<b>NCA</b>	80 x 60 x 2,5	1	0,023	9,1	<b>38,00</b>	
	<b>S0312</b>	<b>RM</b>	90 x 60 x 2,5	1	0,026	10,3	<b>43,00</b>	
	<b>S0313</b>	<b>RSB</b>	100 x 60 x 2,5	1	0,028	11,4	<b>48,00</b>	
	<b>S0314</b>	<b>OL</b>	120 x 60 x 2,5	1	0,034	13,7	<b>57,00</b>	
	<b>S0315</b>	<b>GAV</b>	140 x 60 x 2,5	1	0,040	16,0	<b>67,00</b>	
	<b>S0316</b>	<b>GTO</b>	160 x 60 x 2,5	1	0,045	18,2	<b>76,00</b>	
	<b>S0317</b>	<b>BI</b>	180 x 60 x 2,5	1	0,051	20,5	<b>86,00</b>	
	<b>S0318</b>		200 x 60 x 2,5	1	0,056	22,8	<b>95,00</b>	
	 <p><b>Piano di lavoro sagomato prof. cm.80</b> Shaped desktop depth cm.80 <i>Plan de travail vague profondeur cm.80</i></p>	<b>S0320</b>	<b>NCA</b>	140 x 80 x 2,5	1	0,052	21,3	<b>140,00</b>
		<b>S0321</b>	<b>RM</b> <b>RSB</b> <b>OL</b> <b>GAV</b>	160 x 80 x 2,5	1	0,060	24,3	<b>153,00</b>
<b>S0322</b>		<b>GTO</b> <b>BI</b>	180 x 80 x 2,5	1	0,067	27,4	<b>165,00</b>	
 <p><b>Piano di lavoro sagomato prof. cm.60/80</b> Shaped desktop depth cm.60/80 <i>Plan de travail vague profondeur cm.60/80</i></p>	<b>S0325</b>	<b>NCA</b>	140 x 60/80x2,5	1	0,052	21,3	<b>140,00</b>	
	<b>DX-SX</b>	<b>RM</b> <b>RSB</b> <b>OL</b> <b>GAV</b>	160 x 60/80x2,5	1	0,060	24,3	<b>153,00</b>	
	<b>S0327</b>	<b>GTO</b> <b>BI</b>	180 x 60/80x2,5	1	0,067	27,4	<b>165,00</b>	
 <p><b>Piano di lavoro angolare L.160 P.140</b> Worktop W.160 D.140 <i>Plan compact L.160 P.140</i></p>	<b>S0330</b> <b>DX-SX</b>	<b>NCA</b> <b>RM</b> <b>RSB</b> <b>OL</b> <b>GAV</b> <b>GTO</b> <b>BI</b>	160 x 140 x 2,5	1	0,104	42,6	<b>241,00</b>	
 <p><b>Piano di lavoro angolare L.160 P.160</b> Worktop W.160 D.160 <i>Plan compact L.160 P.160</i></p>	<b>S0331</b> <b>DX-SX</b>	<b>NCA</b> <b>RM</b> <b>RSB</b> <b>OL</b> <b>GAV</b> <b>GTO</b> <b>BI</b>	160 x 160 x 2,5	1	0,118	48,6	<b>266,00</b>	

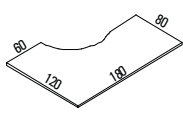
# QUADRA

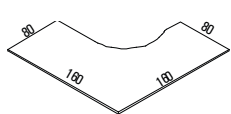
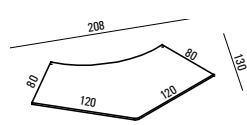
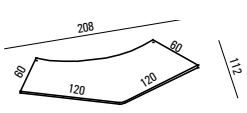
PIANI DI LAVORO OPERATIVE DESKS BUREAUX OPÉRATIONNELS	CODICE CODE CODE	FINITURA PIANI TOP FINISHING FIN. PLANS	L x P x SP. W x D x TH. L x P x EP.	COLLI PACKS COLIS	VOLUMI VOLUME VOLUME	PESO WEIGHT POIDS	PREZZO
							PRICE PRIX €
 <p><b>DX</b></p> <p><b>Piano di lavoro angolare L.180 P.120</b> Worktop W.180 D.120 <i>Plan compact L.180 P.120</i></p>	<b>S0332</b> <b>DX-SX</b>	NCA RM RSB OL GAV GTO BI	180 x 120 x 2,5	1	0,100	41,0	<b>235,00</b>
 <p><b>DX</b></p> <p><b>Piano di lavoro angolare L.200 P.120</b> Worktop W.200 D.120 <i>Plan compact L.200 P.120</i></p>	<b>S0334</b> <b>DX-SX</b>	NCA RM RSB OL GAV GTO BI	200 x 120 x 2,5	1	0,111	45,6	<b>254,00</b>
 <p><b>DX</b></p> <p><b>Piano di lavoro angolare L.160 P.160</b> Worktop W.160 D.160 <i>Plan compact L.160 P.160</i></p>	<b>S0333</b> <b>DX-SX</b>	NCA RM RSB OL GAV GTO BI	160 x 160 x 2,5	1	0,118	48,6	<b>266,00</b>
 <p><b>Piano di lavoro angolare 120° P.80</b> Worktop 120° D.80 <i>Plan compact symétrique 120° P.80</i></p>	<b>S0335</b> <b>DX-SX</b>	NCA RM RSB OL GAV GTO BI	208 x 130 x 2,5	1	0,125	45,4	<b>279,00</b>
 <p><b>Piano di lavoro angolare 120° P.60</b> Worktop 120° D.60 <i>Plan compact symétrique 120° P.60</i></p>	<b>S0336</b> <b>DX-SX</b>	NCA RM RSB OL GAV GTO BI	208 x 112 x 2,5	1	0,111	51,6	<b>253,00</b>

# QUADRA

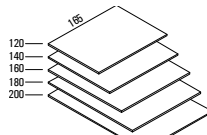
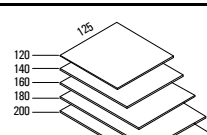
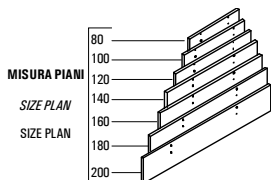
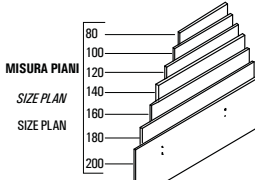
PIANI DI LAVORO POSTAZIONI BENCH E TAVOLI RIUNIONE OPERATIVE DESKS FOR BENCH AND MEETING TABLES BUREAUX OPÉRATIONNELS ET TABLES DE RÉUNION	CODICE CODE CODE	FINITURA PIANI TOP FINISHING FIN. PLANS	L x P x SP. W x D x TH. L x P x EP.	COLLI PACKS COLIS	VOLUMI VOLUME VOLUME	PESO WEIGHT POIDS	PREZZO PRICE PRIX €
 <p><b>Piani di lavoro prof. cm.165</b> Desktop depth cm.165 <i>Plan de travail cm.165</i></p>		<b>NCA</b>					
	<b>S0751</b>	<b>RM</b>	120 x 165 x 2,5	1	0,092	27,8	<b>157,00</b>
	<b>S0752</b>	<b>RSB</b>	140 x 165 x 2,5	1	0,107	32,4	<b>183,00</b>
	<b>S0753</b>	<b>OL</b>	160 x 165 x 2,5	1	0,122	37,0	<b>209,00</b>
	<b>S0754</b>	<b>GAV</b>	180 x 165 x 2,5	1	0,137	41,6	<b>235,00</b>
	<b>S0755</b>	<b>GTO</b>	200 x 165 x 2,5	1	0,152	46,3	<b>261,00</b>
		<b>BI</b>					
 <p><b>Piani di lavoro prof. cm.125</b> Desktop depth cm.125 <i>Plan de travail profondeur cm.125</i></p>		<b>NCA</b>					
	<b>S0761</b>	<b>RM</b>	120 x 125 x 2,5	1	0,070	28,5	<b>119,00</b>
	<b>S0762</b>	<b>RSB</b>	140 x 125 x 2,5	1	0,081	33,3	<b>139,00</b>
	<b>S0763</b>	<b>OL</b>	160 x 125 x 2,5	1	0,093	38,1	<b>159,00</b>
	<b>S0764</b>	<b>GAV</b>	180 x 125 x 2,5	1	0,104	42,8	<b>178,00</b>
	<b>S0765</b>	<b>GTO</b>	200 x 125 x 2,5	1	0,115	47,6	<b>198,00</b>
		<b>BI</b>					
 <p><b>Modesty panel</b> Modesty panel <i>Voile de fond</i></p>	<b>S0600</b>	<b>NCA</b>	68 x 28,4 x 1,8	2	0,009	3,5	<b>46,00</b>
	<b>S0601</b>	<b>RM</b>	88 x 28,4 x 1,8	2	0,011	4,3	<b>49,00</b>
	<b>S0602</b>	<b>RSB</b>	108 x 28,4 x 1,8	2	0,014	5,1	<b>53,00</b>
	<b>S0603</b>	<b>OL</b>	128 x 28,4 x 1,8	2	0,016	5,9	<b>56,00</b>
	<b>S0604</b>	<b>GAV</b>	148 x 28,4 x 1,8	2	0,018	6,7	<b>60,00</b>
	<b>S0605</b>	<b>GTO</b>	168 x 28,4 x 1,8	2	0,020	7,5	<b>63,00</b>
	<b>S0606</b>	<b>BI</b>	188 x 28,4 x 1,8	2	0,023	8,3	<b>67,00</b>
 <p><b>Pannello frontale per scrivanie e tavoli riunione</b> Frontal panel for desks and meeting tables <i>Voile de fond pour postes ou table de réunion</i></p>	<b>S0600.1</b>	<b>NCA</b>	80 x 74 x 1,8	2	0,025	9,0	<b>70,00</b>
	<b>S0601.1</b>	<b>RM</b>	100 x 74 x 1,8	2	0,030	11,1	<b>79,00</b>
	<b>S0602.1</b>	<b>RSB</b>	120 x 74 x 1,8	2	0,036	13,1	<b>88,00</b>
	<b>S0603.1</b>	<b>OL</b>	140 x 74 x 1,8	2	0,042	15,2	<b>97,00</b>
	<b>S0604.1</b>	<b>GAV</b>	160 x 74 x 1,8	2	0,048	17,3	<b>106,00</b>
	<b>S0605.1</b>	<b>GTO</b>	180 x 74 x 1,8	2	0,053	19,3	<b>115,00</b>
	<b>S0606.1</b>	<b>BI</b>	200 x 74 x 1,8	2	0,059	21,4	<b>124,00</b>

# QUADRA

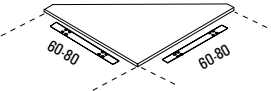
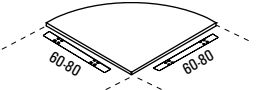
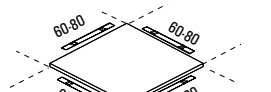
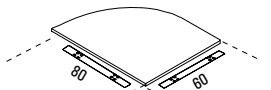
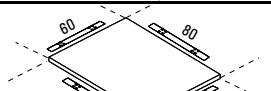
ANGOLI DI COLLEGAMENTO LINKING CORNERS ANGLES DE LIAISON	CODICE CODE CODE	FINITURA PIANI TOP FINISHING FIN. PLANS	L x P x SP. W x D x TH. L x P x EP.	COLLI PACKS COLIS	VOLUMI VOLUME VOLUME	PESO WEIGHT POIDS	PREZZO PRICE PRIX €
 <p><b>Angolo di collegamento 2 vie a 90°</b> 2-way 90° linking angle <i>Angle de liaison à 2 voies</i></p>	<b>S0515</b>	NCA RM RSB OL	80 x 80 x 2,5	1	0,030	13,2	<b>76,00</b>
	<b>S0516</b>	GAV GTO BI	60 x 60 x 2,5	1	0,017	7,8	<b>46,00</b>
 <p><b>Angolo di collegamento 2 vie a 90°</b> 2-way 90° linking angle <i>Angle de liaison à 2 voies</i></p>	<b>S0520</b>	NCA RM RSB OL	80 x 80 x 2,5	1	0,030	13,2	<b>111,00</b>
	<b>S0522</b>	GAV GTO BI	60 x 60 x 2,5	1	0,017	7,8	<b>78,00</b>
 <p><b>Angolo di collegamento 2/3/4 vie</b> 2-3-4 way linking angle <i>Angle de liaison à 2/3/4 voies</i></p>	<b>S0521</b>	NCA RM RSB OL	80 x 80 x 2,5	1	0,030	14,2	<b>85,00</b>
	<b>S0523</b>	GAV GTO BI	60 x 60 x 2,5	1	0,017	0,0	<b>63,00</b>
 <p><b>DX</b></p> <p><b>Angolo di collegamento 2 vie a 90°</b> 2-way 90° linking angle <i>Angle de liaison à 2 voies</i></p>	<b>S0524</b> <b>DX-SX</b>	NCA RM RSB OL GAV GTO BI	80 x 60 x 2,5	1	0,023	10,1	<b>97,00</b>
 <p><b>Angolo di collegamento 2/3/4 vie</b> 2-3-4 way linking angle <i>Angle de liaison à 2/3/4 voies</i></p>	<b>S0525</b>	NCA RM RSB OL GAV GTO BI	80 x 60 x 2,5	1	0,023	11,1	<b>73,00</b>

# QUADRA

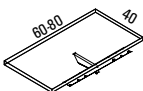
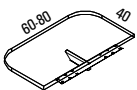
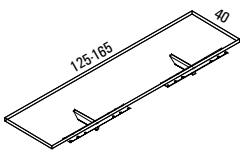
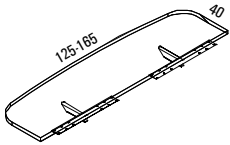
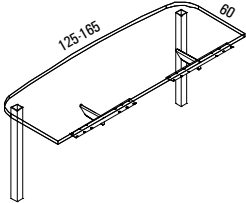
TERMINALI E PENISOLE TERMINAL AND EDGES EXTENSIONS ET CONVIVIALITES	CODICE CODE CODE	FINITURA PIANI TOP FINISHING FIN. PLANS	FIN. GAMBE LEG FINISHING FINITION PIEDS	L x P x SP. W x D x TH. L x P x EP.	COLLI PACKS COLIS	VOLUMI VOLUME VOLUME	PESO WEIGHT POIDS	PREZZO PRICE PRIX
								€
 <b>Terminale</b> Terminal Extension	S0540	NCA RM RSB OL		60 x 40 x 2,5	2	0,012	5,4	48,00
	S0541	GAV GTO BI		80 x 40 x 2,5	2	0,015	7,0	55,00
 <b>Terminale</b> Terminal Extension	S0540.1	NCA RM RSB OL		60 x 40 x 2,5	2	0,012	5,4	83,00
	S0541.1	GAV GTO BI		80 x 40 x 2,5	2	0,015	7,0	90,00
 <b>Terminale</b> Terminal Extension	S0542	NCA RM RSB OL		125,2 x 40 x 2,5	3	0,024	11,3	97,00
	S0544	GAV GTO BI		165,2 x 40 2,5	3	0,031	13,9	111,00
 <b>Terminale</b> Terminal Extension	S0542.1	NCA RM RSB OL		125,2 x 40 x 2,5	3	0,024	11,3	154,00
	S0544.1	GAV GTO BI		165,2 x 40 2,5	3	0,031	14,3	168,00
 <b>Terminale</b> Terminal Extension	SOR547	NCA RM RSB OL	AL BI NR	125,2 x 60 x 72	5	0,069	20,7	257,00
		GAV GTO BI	CR					355,00
	SOR548	NCA RM RSB OL	AL BI NR	165,2 x 60 x 72	5	0,080	25,3	278,00
		GAV GTO BI	CR					376,00

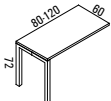
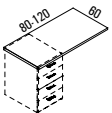
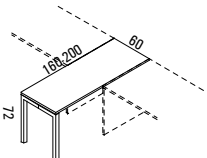
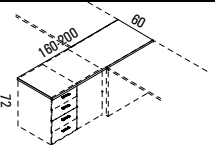

# QUADRA

ALLUNGHI LATERALI LATERAL EXTENSION EXTENSIONS LATÉRALES	CODICE CODE CODE	FINITURA PIANI TOP FINISHING FIN. PLANS	FIN. GAMBE LEG FINISHING FINITION PIEDS	L x P x H W x D x H L x P x H	COLLI PACKS COLIS	VOLUMI VOLUME VOLUME	PESO WEIGHT POIDS	PREZZO PRICE PRIX
								€
 <p><b>Allungo laterale</b> Lateral extension <i>Extension latérale</i></p>	<b>S00410</b>	NCA RM RSB OL	AL BI NR	80 x 60 x 72	2	0,097	15,5	<b>159,00</b>
	<b>S00411</b>	GAV GTO BI	AL BI NR	120 x 60 x 72	2	0,108	20,1	<b>178,00</b>
 <p><b>Allungo laterale per cassettiere portanti</b> Lateral extension for load bearing drawer pedestals <i>Extension latérale pour caissons hauteur bureau</i></p>	<b>S0410</b>	NCA RM RSB OL		80 x 60 x 72	1	0,023	9,6	<b>47,00</b>
	<b>S0411</b>	GAV GTO BI		120 x 60 x 72	1	0,034	14,2	<b>66,00</b>
ALLUNGHI INTERMEDI CENTRAL EXTENSIONS EXTENSIONS CENTRALE	CODICE CODE CODE	FINITURA PIANI TOP FINISHING FIN. PLANS	FIN. GAMBE LEG FINISHING FINITION PIEDS	L x P x H W x D x H L x P x H	COLLI PACKS COLIS	VOLUMI VOLUME VOLUME	PESO WEIGHT POIDS	PREZZO PRICE PRIX €
 <p><b>Allungo intermedio</b> Central extension <i>Extension centrale</i></p>	<b>S00420</b>	NCA RM RSB OL	AL BI NR	160 x 60 x 72	2	0,119	25,1	<b>205,00</b>
	<b>S00421</b>	GAV GTO BI	AL BI NR	200 x 60 x 72	2	0,130	29,7	<b>224,00</b>
 <p><b>Allungo intermedio per cassettiere portanti</b> Central extension for load bearing drawer pedestals <i>Extension centrale pour caissons hauteur bureau</i></p>	<b>S0420</b>	NCA RM RSB OL		160 x 60 x 72	1	0,045	19,2	<b>93,00</b>
	<b>S0421</b>	GAV GTO BI		200 x 60 x 72	1	0,056	23,8	<b>112,00</b>

# QUADRA

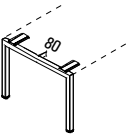
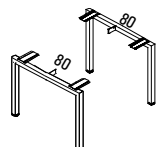
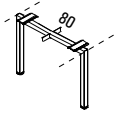
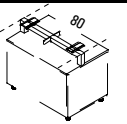
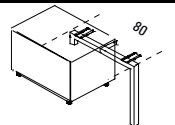
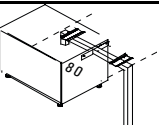
<b>GAMBE METALLICHE P.80</b> <i>METAL LEGS DEPTH 80</i> <i>PIETEMENTS METALLIQUES P.80</i>	<b>CODICE</b> <i>CODE</i> <i>CODE</i>		<b>FIN. GAMBE</b> <i>LEG FINISHING</i> <i>FINITION PIEDS</i>	<b>L x H.</b> <i>W x H.</i> <i>L x P x H.</i>	<b>COLLI</b> <i>PACKS</i> <i>COLIS</i>	<b>VOLUMI</b> <i>VOLUME</i> <i>VOLUME</i>	<b>PESO</b> <i>WEIGHT</i> <i>POIDS</i>	<b>PREZZO</b> <i>PRICE</i> <i>PRIX</i> <b>€</b>
 <p><b>Gamba metallica finale piani Prof.80</b> <i>Final metal leg for desktops depth 80</i> <i>Pied métallique pour plans prof. 80</i></p>	<b>SOQ001F</b>		AL BI NR	80 x 69,5	1	0,097	6,3	102,00
			CR					315,00
 <p><b>Coppia gambe metalliche finali per piani P.80</b> <i>Two final metal legs for desktops depth 80</i> <i>Jeu de pieds métalliques pour plans prof. 80</i></p>	<b>SOQ002F</b>		AL BI NR	80 x 69,5	1	0,097	11,5	196,00
			CR					630,00
 <p><b>Gamba metallica centrale per 2 piani P.80</b> <i>Central metal leg for 2 desktops depth 80</i> <i>Pied métallique centrale pour plans prof. 80</i></p>	<b>SOQ003C</b>		AL BI NR	80 x 69,5	1	0,042	6,5	102,00
			CR					266,00
 <p><b>Gamba metallica portante finale/centrale per 1/2 piani prof. 80</b> <i>Terminal/central metal leg for 1/2 desktops depth 80</i> <i>Pied métallique finale/centrale pour 1/2 plans prof.80</i></p>	<b>SOQ004FC</b>		AL BI NR	80 x 69,5	1	0,016	3,8	150,00
			CR					279,00
 <p><b>Gamba metallica portante finale per 1/2 piani prof.80</b> <i>Terminal metal leg for 1/2 desktops depth 80</i> <i>Pied métallique porteur finale pour 1/2 plans prof. 80</i></p>	<b>SOQ005F</b> <b>DX-SX</b>		AL BI NR	80 x 69,5	1	0,042	5,3	127,00
			CR					252,00
 <p><b>Gamba metallica portante centrale per 1/2 piani prof.80</b> <i>Central metal leg for 1/2 desktops depth 80</i> <i>Pied métallique porteur centrale pour 1/2 plans prof.80</i></p>	<b>SOQ005C</b>		AL BI NR	80 x 69,5	1	0,042	5,3	127,00
			CR					252,00

# QUADRA

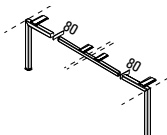
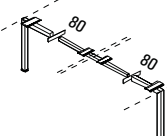
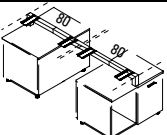
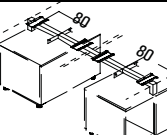
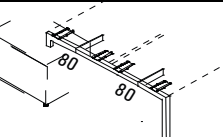
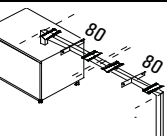
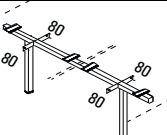
GAMBE METALLICHE P.165 METAL LEGS DEPTH 165 PIETEMENTS METALLIQUES P.165	CODICE CODE CODE	FIN. GAMBE LEG FINISHING FINITION PIEDS	L x H. W x H. L x P x H.	COLLI PACKS COLIS	VOLUMI VOLUME VOLUME	PESO WEIGHT POIDS	PREZZO
							PRICE PRIX €
 <p><b>Gamba metallica doppia finale per 1/2 piani prof.80/165</b> Terminal double metal leg for 1/2 desktops depth 80/165 <i>Pied double métallique pour 1/2 plans prof. 80/165</i></p>	SOQ006F	AL	165 x 69,5	2	0,049	9,6	154,00
		BI					401,00
		NR					
		CR					
 <p><b>Gamba metallica doppia centrale per 2/4 piani prof. 80/165</b> Central double metal leg for 2/4 desktops depth 80/165 <i>Pied double métallique pour 2/4 plans prof. 80/165</i></p>	SOQ006C	AL	165 x 69,5	2	0,049	9,6	154,00
		BI					401,00
		NR					
		CR					
 <p><b>Gamba metallica portante doppia finale per 1/2 piani prof.80/165</b> Double load bearing final metal leg for 1/2 plans depth 80/165 <i>Pied métallique double porteur finale pour 1/2 plans prof.80/165</i></p>	SOQ007F	AL	165 x 69,5	2	0,023	6,9	202,00
		BI					414,00
		NR					
		CR					
 <p><b>Gamba metallica portante doppia centrale per 2/4 piani prof.80/165</b> Double load bearing central metal leg for 2/4 plans depth 80/165 <i>Pied métallique double porteur centrale pour 2/4 plans prof.80/165</i></p>	SOQ007C	AL	165 x 69,5	2	0,023	6,9	202,00
		BI					414,00
		NR					
		CR					
 <p><b>Gamba metallica portante doppia finale per 1/2 piani prof.80/165</b> Double load bearing final metal leg for 1/2 plans depth 80/165 <i>Pied métallique porteur finale pour 1/2 plans prof. 80/165</i></p>	SOQ008F DX-SX	AL	165 x 69,5	2	0,049	8,4	178,00
		BI					387,00
		NR					
		CR					
 <p><b>Gamba metallica portante doppia centrale per 2/4 piani prof.80/165</b> Double load bearing central metal leg for 2/4 plans depth 80/165 <i>Pied métallique porteur centrale pour 2/4 plans prof. 80/165</i></p>	SOQ008C	AL	165 x 69,5	2	0,049	8,4	178,00
		BI					387,00
		NR					
		CR					
 <p><b>Gamba metallica rientrata doppia centrale</b> Central double metal leg for 2/4 desktops depth 80/165 <i>Pied métallique double centrale pour 2/4 plans prof. 80/165</i></p>	SOQ009C	AL	145 x 69,5	2	0,050	9,6	154,00
		BI					401,00
		NR					
		CR					

# QUADRA

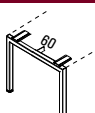
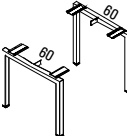
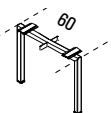
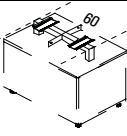

GAMBE METALLICHE P.60 METAL LEGS DEPTH 60 PIETEMENTS METALLIQUES P.60	CODICE CODE CODE		FIN. GAMBE LEG FINISHING FINITION PIEDS	L x H. W x H. L x P x H.	COLLI PACKS COLIS	VOLUMI VOLUME VOLUME	PESO WEIGHT POIDS	PREZZO
								PRICE PRIX €
 <p><b>Gamba metallica finale piani Prof.60</b> Final metal leg for desktops depth 60 <i>Pied métallique pour plans prof. 60</i></p>	S00011F		AL	60 x 69,5	1	0,073	5,5	97,00
			BI					284,00
			NR					
			CR					
 <p><b>Coppia gambe metalliche finali per piani P.60</b> Two final metal legs for desktops depth 60 <i>Jeu de pieds métalliques pour plans prof. 60</i></p>	S00012F		AL	60 x 69,5	1	0,073	10,0	190,00
			BI					567,00
			NR					
			CR					
 <p><b>Gamba metallica centrale per 2 piani P.60</b> Central metal leg for 2 desktops depth 60 <i>Pied métallique centrale pour plans prof. 60</i></p>	S00013C		AL	60 x 69,5	1	0,034	6,0	98,00
			BI					256,00
			NR					
			CR					
 <p><b>Gamba metallica portante finale/centrale per 1/2 piani prof. 60</b> Terminal/central metal leg for 1/2 desktops depth 60 <i>Pied métallique finale/centrale pour 1/2 plans prof.60</i></p>	S00014FC		AL	60 x 69,5	1	0,016	3,8	150,00
			BI					279,00
			NR					
			CR					

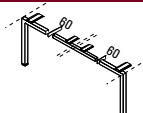
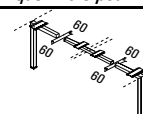
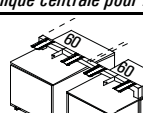
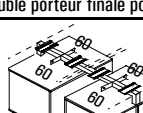
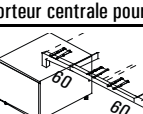
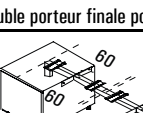
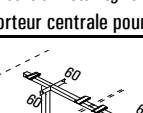
# QUADRA

<b>GAMBE METALLICHE P.125</b> <i>METAL LEGS DEPTH 125</i> <b>PIETEMENTS METALLIQUES P.125</b>	<b>CODICE</b> <i>CODE</i> <b>CODE</b>		<b>FIN. GAMBE</b> <i>LEG FINISHING</i> <b>FINITION PIEDS</b>	<b>L x H.</b> <i>W x H.</i> <b>L x P x H.</b>	<b>COLLI</b> <i>PACKS</i> <b>COLIS</b>	<b>VOLUMI</b> <i>VOLUME</i> <b>VOLUME</b>	<b>PESO</b> <i>WEIGHT</i> <b>POIDS</b>	<b>PREZZO</b> <i>PRICE</i> <b>PRIX</b> €
 <p><b>Gamba metallica doppia finale per 1/2 piani prof. 60/125</b> Terminal double metal leg for 1/2 desktops depth 60/125 <i>Pied double métallique finale pour 1/2 plans prof. 60/125</i></p>	<b>SOQ016F</b>		AL BI NR	125 x 69,5	2	0,041	8,7	146,00
			CR					371,00
 <p><b>Gamba metallica doppia centrale per 2/4 piani prof. 60/125</b> Central double metal leg for 2/4 desktops depth 60/125 <i>Pied double métallique centrale pour 2/4 plans prof. 60/125</i></p>	<b>SOQ016C</b>		AL BI NR	125 x 69,5	2	0,041	8,7	146,00
			CR					371,00
 <p><b>Gamba metallica portante doppia finale per 1/2 piani prof.60/125</b> Double load bearing final metal leg for 1/2 plans depth 60/125 <i>Pied métallique double porteur finale pour 1/2 plans prof.60/125</i></p>	<b>SOQ017F</b>		AL BI NR	125 x 69,5	2	0,023	6,5	199,00
			CR					394,00
 <p><b>Gamba metallica portante doppia centrale per 2/4 piani prof.60/125</b> Double load bearing central metal leg for 2/4 plans depth 60/125 <i>Pied métallique porteur centrale pour 2/4 plans prof. 60/125</i></p>	<b>SOQ017C</b>		AL BI NR	125 x 69,5	2	0,023	6,5	199,00
			CR					394,00
 <p><b>DX</b></p> <p><b>Gamba metallica portante doppia finale per 1/2piani prof.60/125</b> Double load bearing final metal leg for 1/2 plans depth 60/125 <i>Pied métallique double porteur finale pour 1/2plans prof.60/125</i></p>	<b>SOQ018F</b> <b>DX-SX</b>		AL BI NR	125 x 69,5	2	0,049	8,0	175,00
			CR					367,00
 <p><b>Gamba metallica portante doppia centrale per 2/4 piani prof.60/125</b> Double load bearing central metal leg for 2/4 plans depth 60/125 <i>Pied métallique porteur centrale pour 2/4 plans prof. 60/125</i></p>	<b>SOQ018C</b>		AL BI NR	125 x 69,5	2	0,049	8,0	175,00
			CR					367,00
 <p><b>Gamba metallica rientrata doppia centrale per 2/4 piani prof.60/125</b> Central double metal leg for 2/4 desktops depth 60/125 <i>Pied métallique double centrale pour 2/4 plans prof. 60/125</i></p>	<b>SOQ019C</b>		AL BI NR	105 x 69,5	2	0,041	8,7	146,00
			CR					371,00

# QUADRA

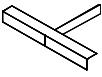
Disponibili in altre finiture: STAFFA e TRAVERSINO (BI-NR); TRAVE (BI-NR-CR). PREZZI DA CALCOLARE  
 Other finishes available for : BRACKET and HOLDING BRACKET (BI-NR); BEAM (BI-NR-CR). PRICES TO BE MADE  
 Des autres finitions pour: ETRIER et ETRIER de SOUTIEN (BI-NR); POUTRE (BI-NR-CR). PRIX A CALCULER





COMPONENTI METALLICI METAL COMPOUNDS COMPOSANTS METALLIQUES	CODICE CODE CODE		FIN. GAMBE LEG FINISHING FINITION PIEDS	L x H. W x H. L x P x H.	COLLI PACKS COLIS	VOLUMI VOLUME VOLUME	PESO WEIGHT POIDS	PREZZO PRICE PRIX €
 <p><b>Staffa aggancio trave per pannelli e cassettiere</b>                      Bracket for beam hooking for panels and drawers  <i>Etrier accrochement poutre pour panneaux et caissons</i></p>	S0020		AL		1	0,031	1,9	46,00
 <p><b>Traversino per gambe singole o per terminali</b>                      Holding bracket for single legs and terminal edges  <i>Etrier de soutien pour pied single ou plans terminales</i></p>	S0022		AL		1	0,000	0,4	16,00
 <p><b>Travi metalliche per piani di lavoro</b>                      Metal beams for working desktops                      Poutres métalliques pour plans de travail</p>	S0030		AL	L.80	1	0,001	1,1	20,00
	S0031		AL	L.100	1	0,002	1,5	24,00
	S0032		AL	L.120	1	0,002	1,8	27,00
	S0033		AL	L.140	1	0,002	2,1	30,00
	S0034		AL	L.160	1	0,003	2,5	34,00
	S0035		AL	L.180	1	0,003	2,9	36,00
	S0036		AL	L.200	1	0,003	3,3	39,00
	S0037		AL	L.220	1	0,004	3,7	43,00

# QUADRA







Disponibili in altre finiture: COMPONENTI PER PIANI SCORREVOLI (BI-NR). PREZZI DA CALCOLARE

Other finishes available for : COMPOUNDS FOR SLIDING DESKS (BI-NR). PRICES TO BE MADE

Des autres finitions pour: COMPOSANTS POUR PLANS COULISSANTES(BI-NR). PRIX A CALCULER

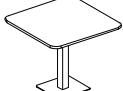
COMPONENTI METALLICI METAL COMPOUNDS COMPOSANTS METALLIQUES	CODICE CODE CODE		FIN. GAMBE LEG FINISHING FINITION PIEDS	L x H. W x H. L x P x H.	COLLI PACKS COLIS	VOLUMI VOLUME VOLUME	PESO WEIGHT POIDS	PREZZO PRICE PRIX €
 <p>H.69,5</p> <p>Gamba metallica di sostegno per scrivanie ad angolo Metal leg for angular desk Pied métallique pour postes compacts</p>	S0040		AL BI	H.69,5 Diam.8	1	0,016	3,6	64,00
 <p>Gamba metallica di sostegn "QUADRATA" per terminali "SQUARE" metal leg for terminal Pied métallique "CARRE" pour rallonges</p>	S0021		AL BI NR	H.69,5	1	0,016	2,4	37,00
		CR	81,00					
 <p>Canalina passacavi per basamento mod. QUADRA Cable duct for line QUADRA Rigole passage cables pour gamme QUADRA</p>	S0025		AL BI NR	69 x 2 x 5	1	0,001	0,5	27,00
<p>COMPONENTI PER PIANI SCORREVOLI METAL COMPOUNDS FOR SLIDING DESKS COMPOSANTS METALLIQUES POUR PLANS COULISSANTS</p>	CODICE CODE CODE		FIN. GAMBE LEG FINISHING FINITION PIEDS	L x H. W x H. L x P x H.	COLLI PACKS COLIS	VOLUMI VOLUME VOLUME	PESO WEIGHT POIDS	PREZZO PRICE PRIX €
 <p>Coppia Kit terminale per N°1 scrivanie scorrevole P.80 Terminal kit for 1 sliding 80 cm depth desktop Jeu de kit terminale pour N°1 plan poste coulissant profondeur 80</p>	S0045		AL	L.80	1	0,003	4,2	65,00
 <p>Kit intermedio per N°2 piani scrivania scorrevoli prof.80 Intermediate kit for 2 sliding 80 cm depth desktop Jeu de kit intermédiaire pour N°2 plan poste coulissant profondeur 80</p>	S0046		AL	L.80	1	0,008	3,5	60,00

# QUADRA

TAVOLI RIUNIONE MEETING TABLES TABLES DE REUNION	CODICE CODE CODE	FINITURA PIANI TOP FINISHING FIN. PLANS	FINITURA GAMBE LEG FINISHING FINITION PIEDS	L x P x H W x D x H L x P x H	COLLI PACKS COLIS	VOLUMI VOLUME VOLUME	PESO WEIGHT POIDS	PREZZO PRICE PRIX	
								€	
 <b>Tavolo circolare diam.90 piano legno (4 posti)</b> <i>Round meeting table D.90 with wooden top (4 seats)</i> Table de réunion ronde D.90 avec plan mélaminé (4 Places)	S0721	NCA RM RSB OL GAV GTO BI	AL	Diam.90 H.75,5	3	0,081	31,4	347,00	
			BI					NR	472,00
 <b>Tavolo circolare diam.90 piano vetro (4 posti)</b> <i>Round meeting table D.90 with glass top (4 seats)</i> Table de réunion ronde D.90 avec plan en verre (4 Places)	S0721V	VS VN VB VC VR	AL	Diam.90 H.74,2	3	0,098	39,7	741,00	
			BI					NR	866,00
			XL					AL	899,00
			BI					NR	1.024,00
			VR					XL	
 <b>Tavolo riunione 90x90 piano legno (4 posti)</b> <i>Meeting table 90x90 with wooden top (4 seats)</i> Table de réunion 90x90 avec plan mélaminé (4 Places)	S0721.1	NCA RM RSB OL GAV GTO BI	AL	90 x 90 x 75,5	3	0,075	33,4	374,00	
			BI					NR	511,00
 <b>Tavolo riunione 90x90 piano vetro (4 posti)</b> <i>Meeting table 90x90 with glass top (4 seats)</i> Table de réunion 90x90 avec plan en verre (4 Places)	S0721.V	VS VN VB VC VR	AL	90 x 90 x 74,2	3	0,092	41,7	768,00	
			BI					NR	905,00
			XL					AL	926,00
			BI					NR	1.062,00
			VR					XL	
 <b>Tavolo circolare diam.120 piano legno (4 posti)</b> <i>Round meeting table D.120 with wooden top (4 seats)</i> Table de réunion ronde D.120 avec plan mélaminé (4 Places)	S0722	NCA RM RSB OL GAV GTO BI	AL	Diam.120 H.75,5	3	0,126	56,4	560,00	
			BI					NR	590,00
 <b>Tavolo circolare diam.120 piano vetro (4 posti)</b> <i>Round meeting table D.120 with glass top (4 seats)</i> Table de réunion ronde D.120 avec plan en verre (4 Places)	S0722V	VS VN VB VC VR	AL	Diam.120 H.74,2	3	0,154	72,1	1.152,00	
			BI					NR	1.182,00
			XL					AL	1.467,00
			BI					NR	1.497,00
			VR					XL	

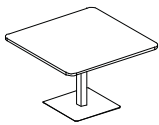
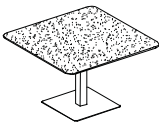
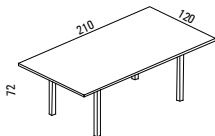
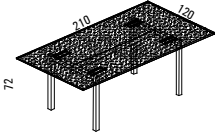
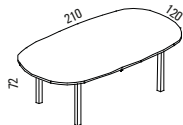
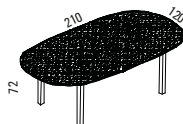

# QUADRA

TAVOLI RIUNIONE MEETING TABLES TABLES DE REUNION	CODICE CODE CODE	FINITURA PIANI TOP FINISHING FIN. PLANS	FIN. GAMBE LEG FINISHING FINITION PIEDS	L x P x H W x D x H L x P x H	COLLI PACKS COLIS	VOLUMI VOLUME VOLUME	PESO WEIGHT POIDS	PREZZO PRICE PRIX
								€
 <p><b>Tavolo riunione 120x120 piano legno (4 posti)</b> <i>Meeting table 120x120 with wooden top (4 seats)</i> Table de réunion 120x120 avec plan mélaminé (4 Places)</p>	S0722.1	NCA RM RSB OL GAV GTO BI	AL BI NR XL	120 x 120 x 75,5	3	0,123	62,4	639,00
		817,00						
 <p><b>Tavolo circolare 120x120 piano vetro (4 posti)</b> <i>Round meeting table 120x120 with glass top (4 seats)</i> Table de réunion ronde 120x120 avec plan en verre (4 Places)</p>	S0722.1V	VS VN VB VC VR	AL BI NR XL	120 x 120 x 74,2	3	0,151	78,1	1.231,00
			1.409,00					
			1.546,00					
			1.724,00					
			1.724,00					
 <p><b>Tavolo riunione L.210x120 piano legno (6-8 posti)</b> <i>Meeting table W.210x120 with wooden top (6-8 seats)</i> Table de réunion L.210x120 avec plan mélaminé (6-8 Places)</p>	S0Q705	NCA RM RSB BI GAV GTO OL	AL BI NR CR	210 x 120 x 72	3	0,215	61,2	442,00
			898,00					
			898,00					
 <p><b>Tavolo riunione L.210x120 piano vetro (6-8 posti)</b> <i>Meeting table W.210x120 with glass top (6-8 seats)</i> Table de réunion L.210x120 avec plan en verre (6-8 Places)</p>	S0Q705V	VS VN VB VC VR	AL BI NR CR	210 x 120 x 72	3	0,262	93,9	1.249,00
			1.705,00					
			1.769,00					
			2.225,00					
			2.225,00					
 <p><b>Tavolo riunione L.210x120 piano legno (6-8 posti)</b> <i>Meeting table W.210x120 with wooden top (6-8 seats)</i> Table de réunion L.210x120 avec plan mélaminé (6-8 Places)</p>	S0Q715	NCA RM RSB BI GAV GTO OL	AL BI NR CR	210 x 120 x 72	3	0,215	61,2	560,00
			1.016,00					
			1.016,00					
 <p><b>Tavolo riunione L.210x120 piano vetro (6-8 posti)</b> <i>Meeting table W.210x120 with glass top (6-8 seats)</i> Table de réunion L.210x120 avec plan en verre (6-8 Places)</p>	S0Q715V	VS VN VB VC VR	AL BI NR CR	210 x 120 x 72	3	0,262	88,7	1.391,00
			1.847,00					
			1.958,00					
			2.414,00					
			2.414,00					

# QUADRA

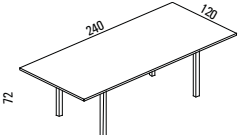
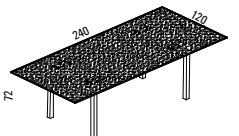
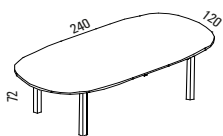
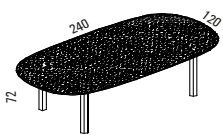
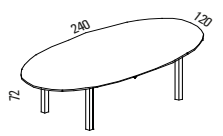
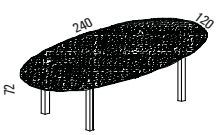
TAVOLI RIUNIONE MEETING TABLES TABLES DE REUNION	CODICE CODE CODE	FINITURA PIANI TOP FINISHING FINITION/PLAN	FIN. GAMBE LEG FINISHING FINITION PIEDS	L x P x H W x D x H L x P x H	COLLI PACKS COLIS	VOLUMI VOLUME VOLUME	PESO WEIGHT POIDS	PREZZO PRICE PRIX
								€
 <b>Tavolo riunione L.240x120 piano legno (8 posti)</b> <i>Meeting table W.240x120 with wooden top (8 seats)</i> Table de réunion L.240x120 avec plan mélaminé (8 Places)	SOQ706	NCA RM RSB OL GAV GTO BI	AL	240 x 120 x 72	3	0,233	68,7	479,00
			CR					935,00
 <b>Tavolo riunione L.240x120 piano vetro (8 posti)</b> <i>Meeting table W.240x120 with glass top (8 seats)</i> Table de réunion L.240x120 avec plan en verre (8 Places)	SOQ706V	VS VN VB VC VR	AL	240 x 120 x 72	3	0,286	106,2	1.375,00
			BI					1.831,00
			NR					2.036,00
			CR					2.492,00
 <b>Tavolo riunione L.240x120 piano legno (8 posti)</b> <i>Meeting table W.240x120 with wooden top (8 seats)</i> Table de réunion L.240x120 avec plan mélaminé (8 Places)	SOQ716	NCA RM RSB OL GAV GTO BI	AL	240 x 120 x 72	3	0,233	68,7	597,00
			CR					1.053,00
 <b>Tavolo riunione L.240x120 piano vetro (8 posti)</b> <i>Meeting table W.240x120 with glass top (8 seats)</i> Table de réunion L.240x120 avec plan en verre (8 Places)	SOQ716V	VS VN VB VC VR	AL	240 x 120 x 72	3	0,286	100,5	1.540,00
			BI					1.996,00
			NR					2.202,00
			CR					2.658,00
 <b>Tavolo riunione ellittico L.240 piano legno (8 posti)</b> <i>Elliptical meeting table W.240 with wooden top (8 seats)</i> Table de réunion elliptique L.240 avec plan mélaminé (8 Places)	SOQ717	NCA RM RSB OL GAV GTO BI	AL	240 x 120 x 72	3	0,233	68,7	597,00
			CR					1.053,00
 <b>Tavolo riunione ellittico L.240 piano vetro (8 posti)</b> <i>Elliptical meeting table W.240 with glass top (8 seats)</i> Table de réunion elliptique L.240 avec plan en verre (8 Places)	SOQ717V	VS VN VB VC VR	AL	240 x 120 x 72	3	0,286	100,5	1.540,00
			BI					1.996,00
			NR					2.202,00
			CR					2.658,00



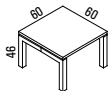
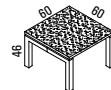
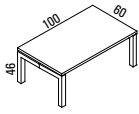
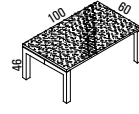
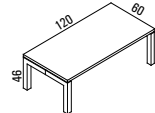
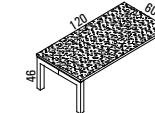

**QUADRA**

**COMPOSIZIONI**

# QUADRA

TAVOLI CAFFÈ COFFEE TABLES TABLES À CAFÉ	CODICE CODE CODE	FINITURA PIANI TOP FINISHING FIN. PLANS	FIN. GAMBE LEG FINISHING FINITION PIEDS	L x P x H W x D x H L x P x H	COLLI PACKS COLIS	VOLUMI VOLUME VOLUME	PESO WEIGHT POIDS	PREZZO PRICE PRIX		
								€		
 <p><b>Tavolo caffè piano legno</b> <i>Coffee table with wooden top</i> Table à café avec plan mélaminé</p>	SOQ780	NCA RM RSB OL GAV GTO BI	AL	60 x 60 H.46	3	0,061	11,6	246,00		
			BI					NR	588,00	
 <p><b>Tavolo caffè piano vetro</b> <i>Coffee table with glass top</i> Table à café avec plan en verre</p>	SOQ780V	VS	AL	60 x 60 H.46	3	0,069	16,3	406,00		
			BI					NR	748,00	
			CR						487,00	
			VN					AL	NR	829,00
			VB					BI	NR	
 <p><b>Tavolo caffè piano legno</b> <i>Coffee table with wooden top</i> Table à café avec plan mélaminé</p>	SOQ781	NCA RM RSB OL GAV GTO BI	AL	100 x 60 H.46	3	0,072	16,9	269,00		
			BI					NR	CR	611,00
 <p><b>Tavolo caffè piano vetro</b> <i>Coffee table with glass top</i> Table à café avec plan en verre</p>	SOQ781V	VS	AL	100 x 60 H.46	3	0,086	24,7	492,00		
			BI					NR	CR	834,00
			VN					AL	NR	627,00
			VB					BI	NR	
			VC					NR	CR	969,00
 <p><b>Tavolo caffè piano legno</b> <i>Coffee table with wooden top</i> Table à café avec plan mélaminé</p>	SOQ782	NCA RM RSB OL GAV GTO BI	AL	120 x 60 H.46	3	0,078	19,5	281,00		
			BI					NR	CR	624,00
 <p><b>Tavolo caffè piano vetro</b> <i>Coffee table with glass top</i> Table à café avec plan en verre</p>	SOQ782V	VS	AL	120 x 60 H.46	3	0,069	16,3	531,00		
			BI					NR	CR	873,00
			VN					AL	NR	675,00
			VB					BI	NR	
			VC					NR	CR	1.017,00

# QUADRA

TAVOLI CAFFÈ COFFEE TABLES TABLES À CAFÈ	CODICE CODE CODE	FINITURA PIANI TOP FINISHING FIN. PLANS	FINITURA GAMBE LEG FINISHING FINITION PIEDS	L x P x H W x D x H L x P x H	COLLI PACKS COLIS	VOLUMI VOLUME VOLUME	PESO WEIGHT POIDS	PREZZO	
								PRICE PRIX €	
 <p><b>Tavolo caffè circolare piano legno diam.60</b> <i>Round coffee table with wooden top diameter 60</i> Table à café ronde avec plan mélaminé diamètre 60</p>	<b>S0783</b>	NCA RM RSB OL GAV GTO BI	AL	Diam.60 H.52,5	3	0,044	21,3	<b>320,00</b>	
			BI					NR	<b>435,00</b>
 <p><b>Tavolo caffè circolare piano vetro diam.60</b> <i>Round coffee table with glass top diameter 60</i> Table à café ronde avec plan en verre diamètre 60</p>	<b>S0783V</b>	VS VN VB VC VR	AL	Diam.60 H.51,2	3	0,053	24,5	<b>592,00</b>	
			BI					NR	<b>707,00</b>
			XL					AL	<b>660,00</b>
			BI					NR	<b>775,00</b>
			VR					XL	
 <p><b>Tavolo caffè 60x60 piano legno</b> <i>Coffee table 60x60 with wooden top</i> Table à café 60x60 avec plan mélaminé</p>	<b>S0783.1</b>	NCA RM RSB OL GAV GTO BI	AL	60 x 60 x 52,5	3	0,052	22,8	<b>324,00</b>	
			BI					NR	<b>448,00</b>
 <p><b>Tavolo caffè 60x60 piano vetro</b> <i>Coffee table 60x60 with glass top</i> Table à café 60x60 avec plan en verre</p>	<b>S0783.1V</b>	VS VN VB VC VR	AL	60 x 60 x 51,2	3	0,061	26,0	<b>596,00</b>	
			BI					NR	<b>721,00</b>
			XL					AL	<b>663,00</b>
			BI					NR	<b>788,00</b>
			VR					XL	



# STUDIOFFICE

## TAU



### STRUTTURE SCRIVANIE

Le gambe metalliche a "T" sono realizzate in lamiera metallica e verniciate a polveri epossidiche nel colore alluminio, bianco e grigio antracite nelle due tipologie, fissa H.72/74 o regolabile manualmente da H.72 cm fino a H 82 cm.

### DESKS STRUCTURES

"T" shaped metallic basement is made of metallic sheet varnished with epossidic paints in aluminium, white and anthracite grey colours in two variants, fixed H.72/74 or hand adjustable from H.72 to H.82.

### STRUCTURES DE BUREAUX

Les pieds métalliques en «T» sont faites de tôle et peint avec poudre époxy aluminium, blanc ou anthracite gris en deux types, fixes H.72/74 ou réglables manuellement cm H.72 à 82 cm H.

01	<b>BI</b> Bianco White Blanc	02	<b>AL</b> Alluminio Aluminium Aluminium	03	<b>GA</b> Grigio antracite Anthracite grey Gris anthracite
----	---------------------------------------	----	--	----	---

\*TAU può essere completato con cassettiere, mobili di servizio, contenitori ed accessori consultabili nelle rispettive sezioni da pag. 141 a seguire.

\*TAU can be completed with drawers, service cabinets, cabinets and accessories to be found in the respective sections from page 141 on

\*TAU peut être complété avec caissons mobiles, des meubles de service, des armoires et accessoires disponibles dans les sections correspondantes à partir de la page 141 à suivre



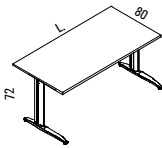
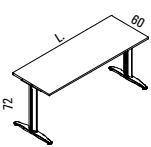

# TAU

SCRIVANIE OPERATIVE OPERATIVE DESKS BUREAUX OPÉRATIONNELS	CODICE CODE CODE	FINITURA PIANI TOP FINISHING FIN. PLANS	FINITURA GAMBE LEG FINISHING FINITION PIEDS	L x P x H W x D x H L x P x H	COLLI PACKS COLIS	VOLUMI VOLUME VOLUME	PESO WEIGHT POIDS	PREZZO PRICE PRIX
								€
 <p><b>Scrivania con gamba DECENTRATA prof. cm.80</b></p> <p>Desk depth cm.80 with decentralizzal leg</p> <p>Poste profondeur cm.80</p>	SOT300	NCA RM RSB OL GAV GTO BI	AL BI GA	80 x 80 x 72	3	0,080	24,6	225,00
	SOT302		AL BI GA	120 x 80 x 72	3	0,095	31,3	256,00
	SOT303		AL BI GA	140 x 80 x 72	3	0,103	34,7	272,00
	SOT304		AL BI GA	160 x 80 x 72	3	0,111	38,1	289,00
	SOT305		AL BI GA	180 x 80 x 72	3	0,118	41,5	304,00
	SOT306		AL BI GA	200 x 80 x 72	3	0,126	45,0	319,00
 <p><b>Scrivania con gamba CENTRATA prof. cm.60</b></p> <p>Desk depth cm.60 with centralised leg</p> <p>Poste profondeur cm.60</p>	SOT311	NCA RM RSB OL GAV GTO BI	AL BI GA	80 x 60 x 72	3	0,072	21,1	205,00
	SOT313		AL BI GA	100 x 60 x 72	3	0,078	23,8	218,00
	SOT314		AL BI GA	120 x 60 x 72	3	0,084	26,4	231,00
	SOT315		AL BI GA	140 x 60 x 72	3	0,090	29,0	243,00
	SOT316		AL BI GA	160 x 60 x 72	3	0,096	31,6	256,00
	SOT317		AL BI GA	180 x 60 x 72	3	0,118	41,1	268,00
	SOT318		AL BI GA	200 x 60 x 72	3	0,126	44,6	281,00

# TAU

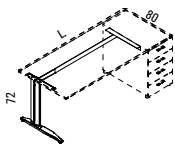
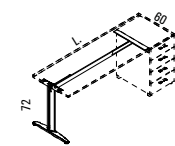
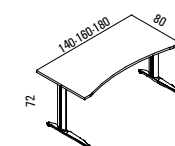
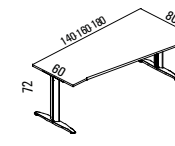
SCRIVANIE OPERATIVE OPERATIVE DESKS BUREAUX OPÉRATIONNELS	CODICE CODE CODE	FINITURA PIANI TOP FINISHING FIN. PLANS	FINITURA GAMBE LEG FINISHING FINITION PIEDS	L x P x H W x D x H L x P x H	COLLI PACKS COLIS	VOLUMI VOLUME VOLUME	PESO WEIGHT POIDS	PREZZO PRICE PRIX
								€
 <p><b>DX</b></p> <p><b>Scrivania portante profondità cm.80</b> Load bearing desk depth cm.80 Poste porteur profondeur cm.80</p>	<b>SOT303S DX-SX</b>	NCA RM RSB OL GAV GTO BI	AL BI GA	140 x 80 x 72	4	0,127	30,3	<b>234,00</b>
	<b>SOT304S DX-SX</b>		AL BI GA	160 x 80 x 72	4	0,134	33,7	<b>250,00</b>
	<b>SOT305S DX-SX</b>		AL BI GA	180 x 80 x 72	4	0,142	37,0	<b>265,00</b>
	<b>SOT306S DX-SX</b>		AL BI GA	200 x 80 x 72	4	0,150	40,5	<b>282,00</b>
 <p><b>DX</b></p> <p><b>Scrivania portante profondità cm.60</b> Load bearing desk depth cm.60 Poste porteur profondeur cm.60</p>	<b>SOT315S DX-SX</b>	NCA RM RSB OL GAV GTO BI	AL BI GA	140 x 60 x 72	4	0,114	24,4	<b>211,00</b>
	<b>SOT316S DX-SX</b>		AL BI GA	160 x 60 x 72	4	0,120	27,0	<b>223,00</b>
	<b>SOT317S DX-SX</b>		AL BI GA	180 x 60 x 72	4	0,126	29,6	<b>236,00</b>
	<b>SOT318S DX-SX</b>		AL BI GA	200 x 60 x 72	4	0,131	32,3	<b>249,00</b>
 <p><b>Scrivania sagomata profondità cm.80</b> Shaped desk depth cm.80 Poste double vague profondeur cm.80</p>	<b>SOT320</b>	NCA RM RSB OL GAV GTO BI	AL BI GA	140 x 80 x 72	3	0,103	34,7	<b>323,00</b>
	<b>SOT321</b>		AL BI GA	160 x 80 x 72	3	0,111	38,1	<b>340,00</b>
	<b>SOT322</b>		AL BI GA	180 x 80 x 72	3	0,118	41,5	<b>355,00</b>
 <p><b>DX</b></p> <p><b>Scrivania sagomata profondità cm.60/80</b> Shaped desk depth cm.60/80 Poste double vague profondeur cm.60/80</p>	<b>SOT325 DX-SX</b>	NCA RM RSB OL GAV GTO BI	AL BI GA	140 x 60/80 x 72	3	0,103	34,3	<b>316,00</b>
	<b>SOT326 DX-SX</b>		AL BI GA	160 x 60/80 x 72	3	0,111	37,7	<b>333,00</b>
	<b>SOT327 DX-SX</b>		AL BI GA	180 x 60/80 x 72	3	0,118	41,1	<b>348,00</b>

# TAU

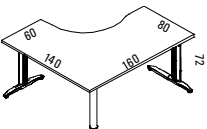
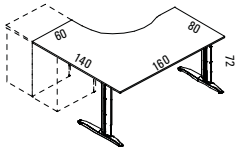
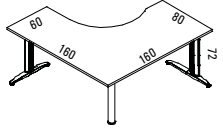
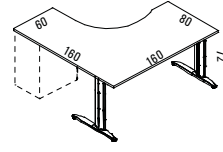
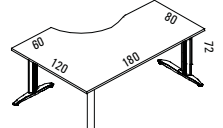
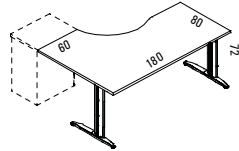

<b>SCRIVANIE OPERATIVE</b> <b>OPERATIVE DESKS</b> <b>BUREAUX OPÉRATIONNELS</b>	<b>CODICE</b> <b>CODE</b> <b>CODE</b>	<b>FINITURA</b> <b>PIANI</b> <small>TOP FINISHING</small> <small>FIN. PLANS</small>	<b>FINITURA GAMBE</b> <b>LEG FINISHING</b> <b>FINITION PIEDS</b>	<b>L x P x H</b> <b>W x D x H</b> <b>L x P x H</b>	<b>COLLI</b> <b>PACKS</b> <b>COLIS</b>	<b>VOLUMI</b> <b>VOLUME</b> <b>VOLUME</b>	<b>PESO</b> <b>WEIGHT</b> <b>POIDS</b>	<b>PREZZO</b> <b>PRICE</b> <b>PRIX</b> <b>€</b>
 <p><b>DX</b></p> <p><b>Scrivania angolare</b> Workstation <i>Poste plan compact</i></p>	<b>SOT330</b> <b>DX-SX</b>	<b>NCA</b> <b>RM</b> <b>RSB</b> <b>OL</b> <b>GAV</b> <b>GTO</b> <b>BI</b>	<b>AL</b> <b>BI</b> <b>GA</b>	160 x 140 x 72	6	0,207	59,9	<b>503,00</b>
 <p><b>DX</b></p> <p><b>Scrivania angolare per cassetiera portante</b> Workstation for load bearing drawer pedestal <i>Poste plan compact pour hauteur bureau</i></p>	<b>SOT330P</b> <b>DX-SX</b>	<b>NCA</b> <b>RM</b> <b>RSB</b> <b>OL</b> <b>GAV</b> <b>GTO</b> <b>BI</b>	<b>AL</b> <b>BI</b> <b>GA</b>	160 x 140 x 72	3	0,154	56,4	<b>428,00</b>
 <p><b>DX</b></p> <p><b>Scrivania angolare</b> Workstation <i>Poste plan compact</i></p>	<b>SOT331</b> <b>DX-SX</b>	<b>NCA</b> <b>RM</b> <b>RSB</b> <b>OL</b> <b>GAV</b> <b>GTO</b> <b>BI</b>	<b>AL</b> <b>BI</b> <b>GA</b>	160 x 160 x 72	6	0,222	66,7	<b>535,00</b>
 <p><b>DX</b></p> <p><b>Scrivania angolare per cassetiera portante</b> Workstation for load bearing drawer pedestal <i>Poste plan compact pour hauteur bureau</i></p>	<b>SOT331P</b> <b>DX-SX</b>	<b>NCA</b> <b>RM</b> <b>RSB</b> <b>OL</b> <b>GAV</b> <b>GTO</b> <b>BI</b>	<b>AL</b> <b>BI</b> <b>GA</b>	160 x 160 x 72	3	0,169	62,4	<b>453,00</b>
 <p><b>DX</b></p> <p><b>Scrivania angolare</b> Workstation <i>Poste plan compact</i></p>	<b>SOT332</b> <b>DX-SX</b>	<b>NCA</b> <b>RM</b> <b>RSB</b> <b>OL</b> <b>GAV</b> <b>GTO</b> <b>BI</b>	<b>AL</b> <b>BI</b> <b>GA</b>	180 x 120 x 72	6	0,203	58,7	<b>500,00</b>
 <p><b>DX</b></p> <p><b>Scrivania angolare per cassetiera portante</b> Workstation for load bearing drawer pedestal <i>Poste plan compact pour hauteur bureau</i></p>	<b>SOT332P</b> <b>DX-SX</b>	<b>NCA</b> <b>RM</b> <b>RSB</b> <b>OL</b> <b>GAV</b> <b>GTO</b> <b>BI</b>	<b>AL</b> <b>BI</b> <b>GA</b>	180 x 120 x 72	3	0,151	55,2	<b>425,00</b>

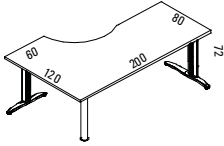
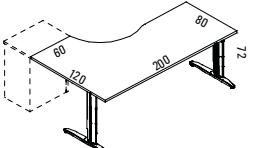
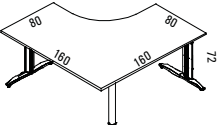
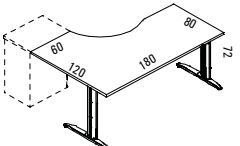
# TAU

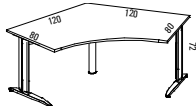
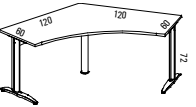

<b>SCRIVANIE OPERATIVE</b> <b>OPERATIVE DESKS</b> <b>BUREAUX OPÉRATIONNELS</b>	<b>CODICE</b> <b>CODE</b> <b>CODE</b>	<b>FINITURA</b> <b>PIANI</b> <small>TOP FINISHING</small> <small>FIN. PLANS</small>	<b>FINITURA GAMBE</b> <small>LEG FINISHING</small> <small>FINITION PIEDS</small>	<b>L x P x H</b> <small>W x D x H</small> <small>L x P x H</small>	<b>COLLI</b> <small>PACKS</small> <small>COLIS</small>	<b>VOLUMI</b> <small>VOLUME</small> <small>VOLUME</small>	<b>PESO</b> <small>WEIGHT</small> <small>POIDS</small>	<b>PREZZO</b> <small>PRICE</small> <small>PRIX</small> <b>€</b>
 <p><b>DX</b></p> <p><b>Scrivania angolare</b> Workstation <i>Poste plan compact</i></p>	<b>SOT334</b> <b>DX-SX</b>	<b>NCA</b> <b>RM</b> <b>RSB</b> <b>OL</b> <b>GAV</b> <b>GTO</b> <b>BI</b>	<b>AL</b>  <b>BI</b>  <b>GA</b>	200 x 120 x 72	6	0,215	63,7	<b>523,00</b>
 <p><b>DX</b></p> <p><b>Scrivania angolare per cassetiera portante</b> Workstation for load bearing drawer pedestal <i>Poste plan compact pour hauteur bureau</i></p>	<b>SOT334P</b> <b>DX-SX</b>	<b>NCA</b> <b>RM</b> <b>RSB</b> <b>OL</b> <b>GAV</b> <b>GTO</b> <b>BI</b>	<b>AL</b>  <b>BI</b>  <b>GA</b>	200 x 120 x 72	3	0,162	60,2	<b>446,00</b>
 <p><b>DX</b></p> <p><b>Scrivania angolare</b> Workstation <i>Poste plan compact</i></p>	<b>SOT333</b> <b>DX-SX</b>	<b>NCA</b> <b>RM</b> <b>RSB</b> <b>OL</b> <b>GAV</b> <b>GTO</b> <b>BI</b>	<b>AL</b>  <b>BI</b>  <b>GA</b>	160 x 160 x 72	5	0,187	67,4	<b>539,00</b>
 <p><b>DX</b></p> <p><b>Scrivania angolare per cassetiera portante</b> Workstation for load bearing drawer pedestal <i>Poste plan compact pour hauteur bureau</i></p>	<b>SOT333P</b> <b>DX-SX</b>	<b>NCA</b> <b>RM</b> <b>RSB</b> <b>OL</b> <b>GAV</b> <b>GTO</b> <b>BI</b>	<b>AL</b>  <b>BI</b>  <b>GA</b>	160 x 160 x 72	3	0,169	62,4	<b>453,00</b>

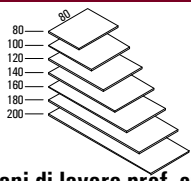
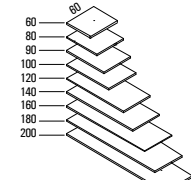
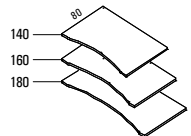
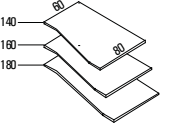
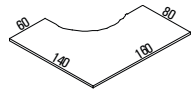
# TAU

<b>SCRIVANIE OPERATIVE</b> <b>OPERATIVE DESKS</b> <b>BUREAUX OPÉRATIONNELS</b>	<b>CODICE</b> <b>CODE</b> <b>CODE</b>	<b>FINITURA</b> <b>PIANI</b> <small>TOP FINISHING</small> <small>FIN. PLANS</small>	<b>FINITURA GAMBE</b> <b>LEG FINISHING</b> <b>FINITION PIEDS</b>	<b>L x P x H</b> <b>W x D x H</b> <b>L x P x H</b>	<b>COLLI</b> <b>PACKS</b> <b>COLIS</b>	<b>VOLUMI</b> <b>VOLUME</b> <b>VOLUME</b>	<b>PESO</b> <b>WEIGHT</b> <b>POIDS</b>	<b>PREZZO</b> <b>PRICE</b> <b>PRIX</b> <b>€</b>
 <p><b>Scrivania angolare 120° P.80</b>  <b>Workstation 120° D.80</b>  <i>Poste plan compact symétrique 120° P.80</i></p>	<b>SOT335</b>	<b>NCA</b> <b>RM</b> <b>RSB</b> <b>OL</b> <b>GAV</b> <b>GTO</b> <b>BI</b>	<b>AL</b> <b>BI</b> <b>GA</b>	208 x 130 x 72	5	0,193	63,2	<b>543,00</b>
 <p><b>Scrivania angolare 120° P.60</b>  <b>Workstation 120° D.60</b>  <i>Poste plan compact symétrique 120° P.60</i></p>								

PIANI DI LAVORO OPERATIVE DESKS BUREAUX OPÉRATIONNELS	CODICE CODE CODE	FINITURA PIANI TOP FINISHING FIN. PLANS		L x P x SP. W x D x TH. L x P x EP.	COLLI PACKS COLIS	VOLUMI VOLUME VOLUME	PESO WEIGHT POIDS	PREZZO PRICE PRIX	
								€	
 <p><b>Piani di lavoro prof. cm.80</b> Desktop depth cm.80 <i>Plan de travail cm.80</i></p>	<b>S0300</b>	<b>NCA</b>		80 x 80 x 2,5	1	0,030	12,2	<b>51,00</b>	
	<b>S0301</b>	<b>RM</b>		100 x 80 x 2,5	1	0,038	15,2	<b>64,00</b>	
	<b>S0302</b>	<b>RSB</b>		120 x 80 x 2,5	1	0,045	18,2	<b>76,00</b>	
	<b>S0303</b>	<b>OL</b>		140 x 80 x 2,5	1	0,052	21,3	<b>89,00</b>	
	<b>S0304</b>	<b>GAV</b>		160 x 80 x 2,5	1	0,060	24,3	<b>101,00</b>	
	<b>S0305</b>	<b>GTO</b>		180 x 80 x 2,5	1	0,067	27,4	<b>114,00</b>	
	<b>S0306</b>	<b>BI</b>		200 x 80 x 2,5	1	0,075	30,4	<b>127,00</b>	
 <p><b>Piani di lavoro prof. cm.60</b> Desktop depth cm.80 <i>Plan de travail profondeur cm.80</i></p>	<b>S0310</b>	<b>NCA</b>		60 x 60 x 2,5	1	0,017	6,8	<b>29,00</b>	
	<b>S0311</b>	<b>RM</b>		80 x 60 x 2,5	1	0,023	9,1	<b>38,00</b>	
	<b>S0312</b>	<b>RSB</b>		90 x 60 x 2,5	1	0,026	10,3	<b>43,00</b>	
	<b>S0313</b>	<b>OL</b>		100 x 60 x 2,5	1	0,028	11,4	<b>48,00</b>	
	<b>S0314</b>	<b>GAV</b>		120 x 60 x 2,5	1	0,034	13,7	<b>57,00</b>	
	<b>S0315</b>	<b>GTO</b>		140 x 60 x 2,5	1	0,040	16,0	<b>67,00</b>	
	<b>S0316</b>	<b>GTO</b>		160 x 60 x 2,5	1	0,045	18,2	<b>76,00</b>	
	<b>S0317</b>	<b>BI</b>		180 x 60 x 2,5	1	0,051	20,5	<b>86,00</b>	
	<b>S0318</b>	<b>BI</b>		200 x 60 x 2,5	1	0,056	22,8	<b>95,00</b>	
	 <p><b>Piano di lavoro sagomato prof. cm.80</b> Shaped desktop depth cm.80 <i>Plan de travail vague profondeur cm.80</i></p>	<b>S0320</b>	<b>NCA</b>		140 x 80 x 2,5	1	0,052	21,3	<b>140,00</b>
		<b>S0321</b>	<b>RM</b> <b>RSB</b> <b>OL</b> <b>GAV</b>		160 x 80 x 2,5	1	0,060	24,3	<b>153,00</b>
<b>S0322</b>		<b>GTO</b> <b>BI</b>		180 x 80 x 2,5	1	0,067	27,4	<b>165,00</b>	
 <p><b>Piano di lavoro sagomato prof. cm.60/80</b> Shaped desktop depth cm.60/80 <i>Plan de travail vague profondeur cm.60/80</i></p>	<b>S0325</b>	<b>NCA</b>		140 x 60/80x2,5	1	0,052	21,3	<b>140,00</b>	
	<b>DX-SX</b>	<b>RM</b> <b>RSB</b> <b>OL</b> <b>GAV</b>		160 x 60/80x2,5	1	0,060	24,3	<b>153,00</b>	
	<b>S0327</b>	<b>GTO</b> <b>BI</b>		180 x 60/80x2,5	1	0,067	27,4	<b>165,00</b>	
<b>DX</b>	<b>S0330</b>	<b>NCA</b>		160 x 140 x 2,5	1	0,104	42,6	<b>241,00</b>	
<b>DX-SX</b>	<b>RM</b> <b>RSB</b> <b>OL</b> <b>GAV</b> <b>GTO</b> <b>BI</b>								
 <p><b>Piano di lavoro angolare L.160 P.140</b> Worktop W.160 D.140 <i>Plan compact L.160 P.140</i></p>									
<b>DX</b>	<b>S0331</b>	<b>NCA</b>		160 x 160 x 2,5	1	0,118	48,6	<b>266,00</b>	
<b>DX-SX</b>	<b>RM</b> <b>RSB</b> <b>OL</b> <b>GAV</b> <b>GTO</b> <b>BI</b>								
 <p><b>Piano di lavoro angolare L.160 P.160</b> Worktop W.160 D.160 <i>Plan compact L.160 P.160</i></p>									

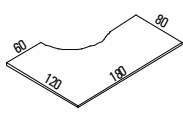
# TAU

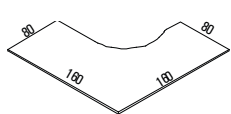
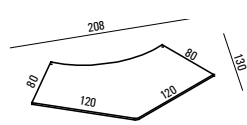
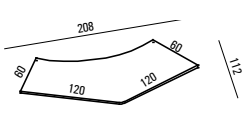
PIANI DI LAVORO OPERATIVE DESKS BUREAUX OPÉRATIONNELS	CODICE CODE CODE	FINITURA PIANI TOP FINISHING FIN. PLANS	L x P x SP. W x D x TH. L x P x EP.	COLLI PACKS COLIS	VOLUMI VOLUME VOLUME	PESO WEIGHT POIDS	PREZZO PRICE PRIX
							€
 <p><b>DX</b></p> <p><b>Piano di lavoro angolare L.180 P.120</b> Worktop W.180 D.120 <i>Plan compact L.180 P.120</i></p>	<b>S0332 DX-SX</b>	NCA RM RSB OL GAV GTO BI	180 x 120 x 2,5	1	0,100	41,0	<b>235,00</b>
 <p><b>DX</b></p> <p><b>Piano di lavoro angolare L.200 P.120</b> Worktop W.200 D.120 <i>Plan compact L.200 P.120</i></p>	<b>S0334 DX-SX</b>	NCA RM RSB OL GAV GTO BI	200 x 120 x 2,5	1	0,111	45,6	<b>254,00</b>
 <p><b>DX</b></p> <p><b>Piano di lavoro angolare L.160 P.160</b> Worktop W.160 D.160 <i>Plan compact L.160 P.160</i></p>	<b>S0333 DX-SX</b>	NCA RM RSB OL GAV GTO BI	160 x 160 x 2,5	1	0,118	48,6	<b>266,00</b>
 <p><b>Piano di lavoro angolare 120° P.80</b> Worktop 120° D.80 <i>Plan compact symétrique 120° P.80</i></p>	<b>S0335 DX-SX</b>	NCA RM RSB OL GAV GTO BI	208 x 130 x 2,5	1	0,125	45,4	<b>279,00</b>
 <p><b>Piano di lavoro angolare 120° P.60</b> Worktop 120° D.60 <i>Plan compact symétrique 120° P.60</i></p>	<b>S0336 DX-SX</b>	NCA RM RSB OL GAV GTO BI	208 x 112 x 2,5	1	0,111	51,6	<b>253,00</b>

# TAU

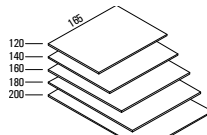
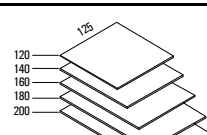
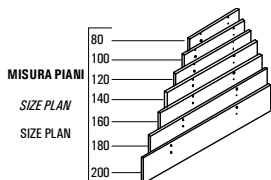
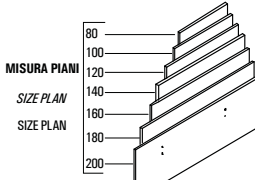
PIANI DI LAVORO POSTAZIONI BENCH E TAVOLI RIUNIONE OPERATIVE DESKS FOR BENCH AND MEETING TABLES BUREAUX OPÉRATIONNELS ET TABLES DE RÉUNION	CODICE CODE CODE	FINITURA PIANI TOP FINISHING FIN. PLANS	L x P x SP. W x D x TH. L x P x EP.	COLLI PACKS COLIS	VOLUMI VOLUME VOLUME	PESO WEIGHT POIDS	PREZZO PRICE PRIX €
 <p><b>Piani di lavoro prof. cm.165</b> Desktop depth cm.165 <i>Plan de travail cm.165</i></p>		<b>NCA</b>					
	<b>S0751</b>	<b>RM</b>	120 x 165 x 2,5	1	0,092	27,8	<b>157,00</b>
	<b>S0752</b>	<b>RSB</b>	140 x 165 x 2,5	1	0,107	32,4	<b>183,00</b>
	<b>S0753</b>	<b>OL</b>	160 x 165 x 2,5	1	0,122	37,0	<b>209,00</b>
	<b>S0754</b>	<b>GAV</b>	180 x 165 x 2,5	1	0,137	41,6	<b>235,00</b>
	<b>S0755</b>	<b>GTO</b>	200 x 165 x 2,5	1	0,152	46,3	<b>261,00</b>
		<b>BI</b>					
 <p><b>Piani di lavoro prof. cm.125</b> Desktop depth cm.125 <i>Plan de travail profondeur cm.125</i></p>		<b>NCA</b>					
	<b>S0761</b>	<b>RM</b>	120 x 125 x 2,5	1	0,070	28,5	<b>119,00</b>
	<b>S0762</b>	<b>RSB</b>	140 x 125 x 2,5	1	0,081	33,3	<b>139,00</b>
	<b>S0763</b>	<b>OL</b>	160 x 125 x 2,5	1	0,093	38,1	<b>159,00</b>
	<b>S0764</b>	<b>GAV</b>	180 x 125 x 2,5	1	0,104	42,8	<b>178,00</b>
	<b>S0765</b>	<b>GTO</b>	200 x 125 x 2,5	1	0,115	47,6	<b>198,00</b>
		<b>BI</b>					
 <p><b>Modesty panel</b> Modesty panel <i>Voile de fond</i></p>	<b>S0600</b>	<b>NCA</b>	68 x 28,4 x 1,8	2	0,009	3,5	<b>46,00</b>
	<b>S0601</b>	<b>RM</b>	88 x 28,4 x 1,8	2	0,011	4,3	<b>49,00</b>
	<b>S0602</b>	<b>RSB</b>	108 x 28,4 x 1,8	2	0,014	5,1	<b>53,00</b>
	<b>S0603</b>	<b>OL</b>	128 x 28,4 x 1,8	2	0,016	5,9	<b>56,00</b>
	<b>S0604</b>	<b>GAV</b>	148 x 28,4 x 1,8	2	0,018	6,7	<b>60,00</b>
	<b>S0605</b>	<b>GTO</b>	168 x 28,4 x 1,8	2	0,020	7,5	<b>63,00</b>
	<b>S0606</b>	<b>BI</b>	188 x 28,4 x 1,8	2	0,023	8,3	<b>67,00</b>
 <p><b>Pannello frontale per scrivanie e tavoli riunione</b> Frontal panel for desks and meeting tables <i>Voile de fond pour postes ou table de réunion</i></p>	<b>S0600.1</b>	<b>NCA</b>	80 x 74 x 1,8	2	0,025	9,0	<b>70,00</b>
	<b>S0601.1</b>	<b>RM</b>	100 x 74 x 1,8	2	0,030	11,1	<b>79,00</b>
	<b>S0602.1</b>	<b>RSB</b>	120 x 74 x 1,8	2	0,036	13,1	<b>88,00</b>
	<b>S0603.1</b>	<b>OL</b>	140 x 74 x 1,8	2	0,042	15,2	<b>97,00</b>
	<b>S0604.1</b>	<b>GAV</b>	160 x 74 x 1,8	2	0,048	17,3	<b>106,00</b>
	<b>S0605.1</b>	<b>GTO</b>	180 x 74 x 1,8	2	0,053	19,3	<b>115,00</b>
	<b>S0606.1</b>	<b>BI</b>	200 x 74 x 1,8	2	0,059	21,4	<b>124,00</b>



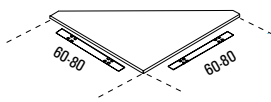
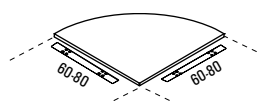
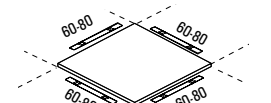
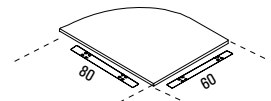
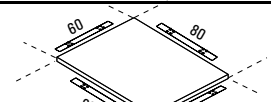

# TAU

ANGOLI DI COLLEGAMENTO LINKING CORNERS ANGLES DE LIAISON	CODICE CODE CODE	FINITURA PIANI TOP FINISHING FIN. PLANS	L x P x SP. W x D x TH. L x P x EP.	COLLI PACKS COLIS	VOLUMI VOLUME VOLUME	PESO WEIGHT POIDS	PREZZO PRICE PRIX €
 <p><b>Angolo di collegamento 2 vie a 90°</b> 2-way 90° linking angle <i>Angle de liaison à 2 voies</i></p>	<b>S0515</b>	NCA RM RSB OL	80 x 80 x 2,5	1	0,030	13,2	<b>76,00</b>
	<b>S0516</b>	GAV GTO BI	60 x 60 x 2,5	1	0,017	7,8	<b>46,00</b>
 <p><b>Angolo di collegamento 2 vie a 90°</b> 2-way 90° linking angle <i>Angle de liaison à 2 voies</i></p>	<b>S0520</b>	NCA RM RSB OL	80 x 80 x 2,5	1	0,030	13,2	<b>111,00</b>
	<b>S0522</b>	GAV GTO BI	60 x 60 x 2,5	1	0,017	7,8	<b>78,00</b>
 <p><b>Angolo di collegamento 2/3/4 vie</b> 2-3-4 way linking angle <i>Angle de liaison à 2/3/4 voies</i></p>	<b>S0521</b>	NCA RM RSB OL	80 x 80 x 2,5	1	0,030	14,2	<b>85,00</b>
	<b>S0523</b>	GAV GTO BI	60 x 60 x 2,5	1	0,017	0,0	<b>63,00</b>
 <p><b>DX</b></p> <p><b>Angolo di collegamento 2 vie a 90°</b> 2-way 90° linking angle <i>Angle de liaison à 2 voies</i></p>	<b>S0524 DX-SX</b>	NCA RM RSB OL GAV GTO BI	80 x 60 x 2,5	1	0,023	10,1	<b>97,00</b>
 <p><b>Angolo di collegamento 2/3/4 vie</b> 2-3-4 way linking angle <i>Angle de liaison à 2/3/4 voies</i></p>	<b>S0525</b>	NCA RM RSB OL GAV GTO BI	80 x 60 x 2,5	1	0,023	11,1	<b>73,00</b>

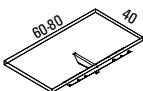
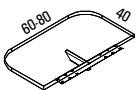
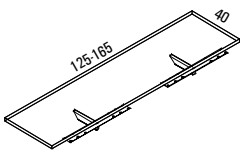
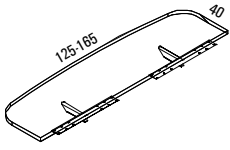
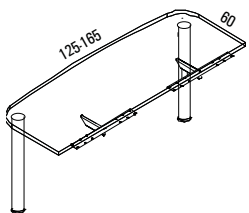



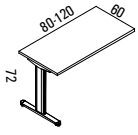
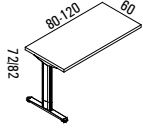
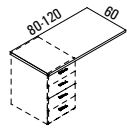
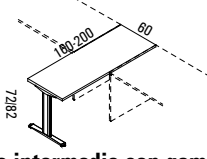

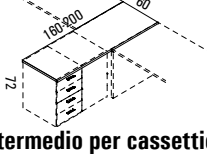
# TAU

TERMINALI E PENISOLE TERMINAL AND EDGES EXTENSIONS ET CONVIVIALITES	CODICE CODE CODE	FINITURA PIANI TOP FINISHING FIN. PLANS	FIN. GAMBE LEG FINISHING FINITION PIEDS	L x P x SP. W x D x TH. L x P x EP.	COLLI PACKS COLIS	VOLUMI VOLUME VOLUME	PESO WEIGHT POIDS	PREZZO PRICE PRIX
								€
 <b>Terminale</b> Terminal Extension	<b>S0540</b>	NCA RM RSB OL		60 x 40 x 2,5	2	0,012	5,4	<b>48,00</b>
	<b>S0541</b>	GAV GTO BI		80 x 40 x 2,5	2	0,015	7,0	<b>55,00</b>
 <b>Terminale</b> Terminal Extension	<b>S0540.1</b>	NCA RM RSB OL		60 x 40 x 2,5	2	0,012	5,4	<b>83,00</b>
	<b>S0541.1</b>	GAV GTO BI		80 x 40 x 2,5	2	0,015	7,0	<b>90,00</b>
 <b>Terminale</b> Terminal Extension	<b>S0542</b>	NCA RM RSB OL		125,2 x 40 x 2,5	3	0,024	11,3	<b>97,00</b>
	<b>S0544</b>	GAV GTO BI		165,2 x 40 x 2,5	3	0,031	13,9	<b>111,00</b>
 <b>Terminale</b> Terminal Extension	<b>S0542.1</b>	NCA RM RSB OL		125,2 x 40 x 2,5	3	0,024	11,3	<b>154,00</b>
	<b>S0544.1</b>	GAV GTO BI		165,2 x 40 x 2,5	3	0,031	14,3	<b>168,00</b>
 <b>Terminale</b> Terminal Extension	<b>S0T547</b>	NCA RM RSB OL GAV GTO BI	AL BI GA	125,2 x 60 x 72	5	0,069	21,0	<b>231,00</b>
	<b>S0T548</b>	NCA RM RSB OL GAV GTO BI	AL BI GA	165,2 x 60 x 72	5	0,080	25,6	<b>250,00</b>







# TAU

ALLUNGHI LATERALI LATERAL EXTENSION EXTENSIONS LATÉRALE	CODICE CODE CODE	FINITURA PIANI TOP FINISHING FIN. PLANS	FINITURA GAMBE LEG FINISHING FINITION PIEDS	L x P x H W x D x H L x P x H	COLLI PACKS COLIS	VOLUMI VOLUME VOLUME	PESO WEIGHT POIDS	PREZZO PRICE PRIX
								€
 <p><b>Allungo laterale con gamba fissa</b> Lateral extension for wooden desks with fixed leg <i>Extension laterale avec pied fixe</i></p>	SOT410	NCA RM RSB	AL BI GA	80 x 60 x 72	2	0,065	15,2	138,00
	SOT411	OL GAV GTO BI	AL BI GA	120 x 60 x 72	2	0,076	19,7	157,00
 <p><b>Allungo laterale con gamba regolabile</b> Lateral extension with adjustable leg <i>Extension laterale avec pied réglable</i></p>	SOT410R	NCA RM RSB	AL BI GA	80 x 60 x 72/82	2	0,065	17,8	182,00
	SOT411R	OL GAV GTO BI	AL BI GA	120 x 60 x 72/82	2	0,076	22,4	201,00
 <p><b>Allungo laterale per cassettiere portanti</b> Lateral extension for load bearing drawer pedestals <i>Extension laterale pour caissons hauteur bureau</i></p>	S0410	NCA RM RSB	AL BI GA	80 x 60 x 72	1	0,023	9,6	47,00
	S0411	OL GAV GTO BI	AL BI GA	120 x 60 x 72	1	0,034	14,2	66,00
ALLUNGHI INTERMEDI CENTRAL EXTENSIONS EXTENSIONS CENTRALES	CODICE CODE CODE	FINITURA PIANI TOP FINISHING FIN. PLANS	FINITURA GAMBE LEG FINISHING FINITION PIEDS	L x P x H W x D x H L x P x H	COLLI PACKS COLIS	VOLUMI VOLUME VOLUME	PESO WEIGHT POIDS	PREZZO PRICE PRIX €
 <p><b>Allungo intermedio con gamba fissa</b> Central extension with fixed leg <i>Extension centrale avec pied Fixe</i></p>	SOT420	NCA RM RSB	AL BI GA	160 x 60 x 72	2	0,088	24,8	184,00
	SOT421	OL GAV GTO BI	AL BI GA	200 x 60 x 72	2	0,099	29,3	203,00
 <p><b>Allungo intermedio con gamba regolabile</b> Central extension with adjustable leg <i>Extension centrale avec pied réglable</i></p>	SOT420R	NCA RM RSB	AL BI GA	160 x 60 x 72/82	2	0,088	27,4	229,00
	SOT421R	OL GAV GTO BI	AL BI GA	200 x 60 x 72/82	2	0,099	32,0	248,00
 <p><b>Allungo intermedio per cassettiere portanti</b> Central extension for load bearing drawer pedestals <i>Extension centrale pour caissons hauteur bureau</i></p>	S0420	NCA RM RSB	AL BI GA	160 x 60 x 72	1	0,045	19,2	93,00
	S0421	OL GAV GTO BI	AL BI GA	200 x 60 x 72	1	0,056	23,8	112,00

# TAU



GAMBE METALLICHE METAL LEGS PIÈTEMENTS METALLIQUES		CODICE CODE CODE		FINITURA GAMBE LEG FINISHING FINITION PIÈDS	L x H. W x H. L x P x H.	COLLI PACKS COLIS	VOLUMI VOLUME VOLUME	PESO WEIGHT POIDS	PREZZO PRICE PRIX €
	H.69,5	SOT001		AL BI GA	H.69,5	1	0,042	5,4	77,00
Gamba CENTRATA fissa per 1/2 piani prof.80 Fixed CENTERED leg for 1/2 desktops depth 80 <i>Pied fixe CENTRE pour 1/2 plans prof. 80</i>									
	H.69,5		SOT001.2		AL BI GA	H.69,5	1	0,048	
Coppia gambe CENTRATE fisse per 1piano prof.80 Two fixed CENTERED legs for 1 desktop depth 80 <i>Deux pieds fixes CENTRÉS pour 1 plan prof. 80</i>									
	H.69,5/79,5	SOT001R		AL BI GA	H.69,5/79,5	1	0,042	7,9	121,00
Gamba CENTRATA regolabile per 1/2 piani prof.80 Adjustable CENTERED leg for 1/2 desktops depth 80 <i>Pied réglable CENTRE pour 1/2 plans prof. 80</i>									
	H.69,5/79,5		SOT001.2R		AL BI GA	H.69,5/79,5	1	0,048	
Coppia gambe CENTRATE regolabili per 1 piano prof.80 Two adjustable CENTERED legs for 1 desktop depth 80 <i>Deux pieds réglables CENTRÉS pour 1 plan prof.80</i>									
	H.69,5	SOT002		AL BI GA	H.69,5	1	0,042	5,2	76,00
Gamba CENTRATA fissa per 1/2 piani prof.60 Fixed CENTERED leg for 1/2 desktops depth 60 <i>Pied fixe CENTRE pour 1/2 plans prof. 60</i>									
	H.69,5		SOT002.2		AL BI GA	H.69,5	1	0,048	
Coppia gambe CENTRATE fisse per 1 piano prof.60 Two fixed legs CENTERED for 1 desktop depth 60 <i>Deux pieds fixes CENTRÉS pour 1 plan prof.60</i>									

# TAU



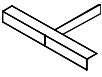

GAMBE METALLICHE METAL LEGS PIETEMENTS METALLIQUES		CODICE CODE CODE		FINITURA GAMBE LEG FINISHING FINITION PIEDS	L x H. W x H. L x P x H.	COLLI PACKS COLIS	VOLUMI VOLUME VOLUME	PESO WEIGHT POIDS	PREZZO PRICE PRIX €	
	H.69,5/79,5	SOT002R		AL BI GA	H.69,5/79,5	1	0,042	7,8	121,00	
Gamba CENTRATA regolabile per 1/2 piani prof.60 Adjustable leg CENTERED for 1/2 desktops depth 60 <i>Pied réglable CENTRE pour 1/2 plans prof. 60</i>										
	H.69,5	SOT010.2		AL BI GA	H.69,5	1	0,048	11,3	154,00	
Coppia gambe DECENTRATE fisse per 1 piano prof.80 Two fixed DECENTRALIZED legs for 1 desktop depth 80 <i>Deux pieds fixes DEGAGEMENT laterale pour 1 plan prof. 80</i>										
	H.69,5/79,5	SOT011.2		Articolo non ancora disponibile						
Coppia gambe DECENTRATE regolabili per 1 piano prof.80 Two adjustable DECENTRALIZED legs for 1 desktop depth 80 <i>Deux pieds réglables DEGAGEMENT laterale pour 1 plan prof. 80</i>					Not available item					
					Article pas disponible					
	H.69,5	S0040		AL BI GA	H.69,5 Diam.8	1	0,016	3,6	64,00	
Gamba metallica di sostegno per scrivanie ad angolo Metal leg for angular desk <i>Pied métallique pour postes compacts</i>										
	H.69,5	SOT041		AL BI GA	H.69,5 Diam.6	1	0,016	2,5	37,00	
Gamba metallica autoportante Freestanding metal leg <i>Pied métallique autoportant</i>										
		SOT044		AL BI GA		1	0,037	3,8	66,00	
Porta pc con aggancio sulla gamba a "T" Cpu holding shelf to be fixed on the "T" leg <i>Porte pc avec accrochement sur le pied "T"</i>										

# TAU

Disponibili in altre finiture: STAFFA e TRAVERSINO (BI-NR); TRAVE (BI-NR-CR). PREZZI DA CALCOLARE  
 Other finishes available for : BRACKET and HOLDING BRACKET (BI-NR); BEAM (BI-NR-CR). PRICES TO BE MADE  
 Des autres finitions pour: ETRIER et ETRIER de SOUTIEN (BI-NR); POUTRE (BI-NR-CR). PRIX A CALCULER

COMPONENTI METALLICI METAL COMPOUNDS COMPOSANTS METALLIQUES	CODICE CODE CODE	FIN. GAMBE LEG FINISHING FINITION PIEDS	L x H. W x H. L x P x H.	COLLI PACKS COLIS	VOLUMI VOLUME VOLUME	PESO WEIGHT POIDS	PREZZO
							PRICE PRIX €
 <b>Staffa aggancio trave per pannelli e cassettiere</b> Bracket for beam hooking for panels and drawers <i>Etrier accrochement poutre pour panneaux et caissons</i>	S0020	AL		1	0,031	1,9	46,00
	S0022	AL		1	0,000	0,4	16,00
 <b>Traversino per gambe singole o per terminali</b> Holding bracket for single legs and terminal edges <i>Etrier de soutien pour pied single ou plans terminales</i>   <b>Travi metalliche per piani di lavoro</b> Metal beams for working desktops <i>Poutres métalliques pour plans de travail</i>	S0030	AL	L.80	1	0,001	1,1	20,00
	S0031	AL	L.100	1	0,002	1,5	24,00
	S0032	AL	L.120	1	0,002	1,8	27,00
	S0033	AL	L.140	1	0,002	2,1	30,00
	S0034	AL	L.160	1	0,003	2,5	34,00
	S0035	AL	L.180	1	0,003	2,9	36,00
	S0036	AL	L.200	1	0,003	3,3	39,00
	S0037	AL	L.220	1	0,004	3,7	43,00

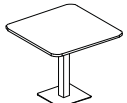
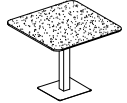
# TAU

TAVOLI RIUNIONE MEETING TABLES TABLES DE REUNION	CODICE CODE CODE	FINITURA PIANI TOP FINISHING FIN. PLANS	FINITURA GAMBE LEG FINISHING FINITION PIEDS	L x P x H W x D x H L x P x H	COLLI PACKS COLIS	VOLUMI VOLUME VOLUME	PESO WEIGHT POIDS	PREZZO PRICE PRIX	
								€	
 <p><b>Tavolo circolare diam.90 piano legno (4 posti)</b> <i>Round meeting table D.90 with wooden top (4 seats)</i> Table de réunion ronde D.90 avec plan mélaminé (4 Places)</p>	S0721	NCA RM RSB OL GAV GTO BI	AL	Diam.90 H.75,5	3	0,081	31,4	347,00	
			BI					NR	472,00
 <p><b>Tavolo circolare diam.90 piano vetro (4 posti)</b> <i>Round meeting table D.90 with glass top (4 seats)</i> Table de réunion ronde D.90 avec plan en verre (4 Places)</p>	S0721V	VS VN VB VC VR	AL	Diam.90 H.74,2	3	0,098	39,7	741,00	
			BI					NR	866,00
			XL					AL	899,00
			BI					NR	1.024,00
			VR					XL	1.024,00
 <p><b>Tavolo riunione 90x90 piano legno (4 posti)</b> <i>Meeting table 90x90 with wooden top (4 seats)</i> Table de réunion 90x90 avec plan mélaminé (4 Places)</p>	S0721.1	NCA RM RSB OL GAV GTO BI	AL	90 x 90 x 75,5	3	0,075	33,4	374,00	
			BI					NR	511,00
 <p><b>Tavolo riunione 90x90 piano vetro (4 posti)</b> <i>Meeting table 90x90 with glass top (4 seats)</i> Table de réunion 90x90 avec plan en verre (4 Places)</p>	S0721.V	VS VN VB VC VR	AL	90 x 90 x 74,2	3	0,092	41,7	768,00	
			BI					NR	905,00
			XL					AL	926,00
			BI					NR	1.062,00
			VR					XL	1.062,00
 <p><b>Tavolo circolare diam.120 piano legno (4 posti)</b> <i>Round meeting table D.120 with wooden top (4 seats)</i> Table de réunion ronde D.120 avec plan mélaminé (4 Places)</p>	S0722	NCA RM RSB OL GAV GTO BI	AL	Diam.120 H.75,5	3	0,126	56,4	560,00	
			BI					NR	590,00
 <p><b>Tavolo circolare diam.120 piano vetro (4 posti)</b> <i>Round meeting table D.120 with glass top (4 seats)</i> Table de réunion ronde D.120 avec plan en verre (4 Places)</p>	S0722V	VS VN VB VC VR	AL	Diam.120 H.74,2	3	0,154	72,1	1.152,00	
			BI					NR	1.182,00
			XL					AL	1.467,00
			BI					NR	1.497,00
			VR					XL	1.497,00

# TAU

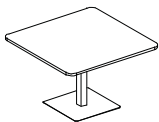
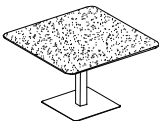
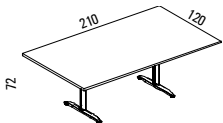
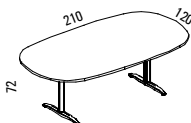
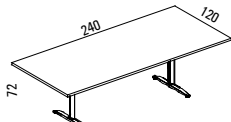
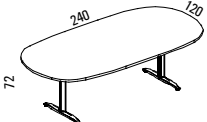
TAVOLI RIUNIONE MEETING TABLES TABLES DE REUNION	CODICE CODE CODE	FINITURA PIANI TOP FINISHING FIN. PLANS	FIN. GAMBE LEG FINISHING FINITION PIEDS	L x P x H W x D x H L x P x H	COLLI PACKS COLIS	VOLUMI VOLUME VOLUME	PESO WEIGHT POIDS	PREZZO PRICE PRIX
								€
 <p><b>Tavolo riunione 120x120 piano legno (4 posti)</b> <i>Meeting table 120x120 with wooden top (4 seats)</i> Table de réunion 120x120 avec plan mélaminé (4 Places)</p>	S0722.1	NCA RM RSB OL GAV GTO BI	AL	120 x 120 x 75,5	3	0,123	62,4	639,00
			XL					817,00
 <p><b>Tavolo circolare 120x120 piano vetro (4 posti)</b> <i>Round meeting table 120x120 with glass top (4 seats)</i> Table de réunion ronde 120x120 avec plan en verre (4 Places)</p>	S0722.1V	VS	AL	120 x 120 x 74,2	3	0,151	78,1	1.231,00
			BI					1.409,00
			NR					1.546,00
			XL					1.724,00
 <p><b>Tavolo riunione L.210x120 piano legno (6-8 posti)</b> <i>Meeting table W.210x120 with wooden top (6-8 seats)</i> Table de réunion L.210x120 avec plan mélaminé (6-8 Places)</p>	S07705	NCA RM RSB OL GAV GTO BI	AL	210 x 120 H.72	3	0,167	60,1	392,00
			BI					
			GA					
 <p><b>Tavolo riunione L.210x120 piano legno (6-8 posti)</b> <i>Meeting table W.210x120 with wooden top (6-8 seats)</i> Table de réunion L.210x120 avec plan mélaminé (6-8 Places)</p>	S07715	NCA RM RSB OL GAV GTO BI	AL	210 x 120 H.72	3	0,167	60,1	510,00
			BI					
			GA					
 <p><b>Tavolo riunione L.240x120 piano legno (8 posti)</b> <i>Meeting table W.240x120 with wooden top (8 seats)</i> Table de réunion L.240x120 avec plan mélaminé (8 Places)</p>	S07706	NCA RM RSB OL GAV GTO BI	AL	240 x 120 H.72	3	0,184	67,6	429,00
			BI					
			GA					
 <p><b>Tavolo riunione L.240x120 piano legno (8 posti)</b> <i>Meeting table W.240x120 with wooden top (8 seats)</i> Table de réunion L.240x120 avec plan mélaminé (8 Places)</p>	S07716	NCA RM RSB OL GAV GTO BI	AL	240 x 120 H.72	3	0,184	67,6	547,00
			BI					
			GA					





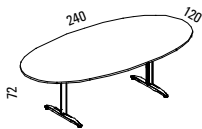

# TAU

TAVOLI RIUNIONE MEETING TABLES TABLES DE REUNION	CODICE CODE CODE	FINITURA PIANI TOP FINISHING FIN. PLANS	FIN. GAMBE LEG FINISHING FINITION PIEDS	L x P x H W x D x H L x P x H	COLLI PACKS COLIS	VOLUMI VOLUME VOLUME	PESO WEIGHT POIDS	PREZZO PRICE PRIX
								€
 <p>Tavolo riunione ellittico L.240 piano legno (8 posti)  <i>Elliptical meeting table W.240 with wooden top (8 seats)</i>            Table de réunion elliptique L.240 avec plan mélaminé (8 Places)</p>	S0T717	NCA		240 x 120 H.72	3	0,184	67,6	547,00
RM		AL						
RSB		BI						
OL		GA						
GAV								
GTO								
BI								

## COMPOSIZIONI

# TAU

TAVOLI CAFFÈ COFFEE TABLES TABLES À CAFÉ	CODICE CODE CODE	FINITURA PIANI TOP FINISHING FIN. PLANS	FINITURA GAMBE LEG FINISHING FINITION PIEDS	L x P x H W x D x H L x P x H	COLLI PACKS COLIS	VOLUMI VOLUME VOLUME	PESO WEIGHT POIDS	PREZZO PRICE PRIX		
								€		
 <p><b>Tavolo caffè circolare piano legno diam.60</b> <i>Round coffee table with wooden top diameter 60</i> Table à café ronde avec plan mélaminé diamètre 60</p>	<b>S0783</b>	NCA RM RSB OL GAV GTO BI	AL	Diam.60 H.52,5	3	0,044	21,3	<b>320,00</b>		
			BI					NR	<b>435,00</b>	
 <p><b>Tavolo caffè circolare piano vetro diam.60</b> <i>Round coffee table with glass top diameter 60</i> Table à café ronde avec plan en verre diamètre 60</p>	<b>S0783V</b>	VS VN VB VC VR	AL	Diam.60 H.51,2	3	0,053	24,5	<b>592,00</b>		
			BI					NR	<b>707,00</b>	
			XL					AL	<b>660,00</b>	
			BI					NR	<b>775,00</b>	
			VR					XL		
 <p><b>Tavolo caffè 60x60 piano legno</b> <i>Coffee table 60x60 with wooden top</i> Table à café 60x60 avec plan mélaminé</p>	<b>S0783.1</b>	NCA RM RSB OL GAV GTO BI	AL	60 x 60 x 52,5	3	0,052	22,8	<b>324,00</b>		
			BI					NR	XL	<b>448,00</b>
 <p><b>Tavolo caffè 60x60 piano vetro</b> <i>Coffee table 60x60 with glass top</i> Table à café 60x60 avec plan en verre</p>	<b>S0783.1V</b>	VS VN VB VC VR	AL	60 x 60 x 51,2	3	0,061	26,0	<b>596,00</b>		
			BI					NR	XL	<b>721,00</b>
			AL					BI	<b>663,00</b>	
			VC					NR	<b>788,00</b>	
			VR					XL		

## STUDIO OFFICE

### OPEN WORK



#### OPEN WORK

Il sistema è composto da due tipologie di paretine: una realizzata con uno due pannelli di particelle di legno nobilitati melaminico e bordati perimetralmente con un telaio in materiale plastico altamente resistente; l'altra composta da un singolo pannello di particelle di legno nobilitato melaminico bordato abs.

Lo spessore del pannello è di 2,5

cm.

Le altezze disponibili sono: cm 82,6-113-121-160,6

#### OPEN WORK

*The system is made by two different kind of partitioning. The first one is made by melaminic panels framed by highly resistant plastic material. The other one is made by a melaminic panel abs edged.*

*Panel thickness is 2,5 cm*

*Heights available are 82,6; 113; 121; 160,6.*

#### OPEN WORK

Le système est composé de deux types de parois de séparation : une faite avec un- deux panneaux de particules de bois finition mélamine avec un châssis en matière plastique très résistante ; l'autre se compose d'un seul panneau de particules de bois finition mélaminé avec chants abs . L'épaisseur du panneau est de 2,5 cm .

Les hauteurs sont disponibles: cm 82,6-113-121-160,6

**\*OPEN WORK può essere completato con cassettiere, mobili di servizio, contenitori ed accessori consultabili nelle rispettive sezioni da pag. 141 a seguire.**

*\*OPEN WORK can be completed with drawers, service cabinets, cabinets and accessories to be found in the respective sections from page 141 on*

*\*OPEN WORK peut être complété avec caissons mobiles, des meubles de service, des armoires et accessoires disponibles dans les sections correspondantes à partir de la page 141 à suivre*

# OPEN WORK

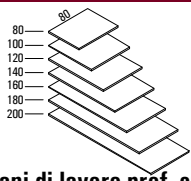
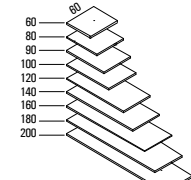
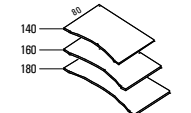
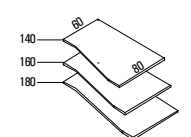
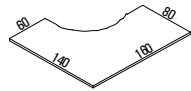
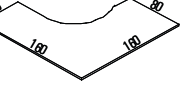

PIANI DI LAVORO OPERATIVE DESKS BUREAUX OPÉRATIONNELS	CODICE CODE CODE	FINITURA PIANI TOP FINISHING FIN. PLANS		L x P x SP. W x D x TH. L x P x EP.	COLLI PACKS COLIS	VOLUMI VOLUME VOLUME	PESO WEIGHT POIDS	PREZZO PRICE PRIX	
								€	
 <p><b>Piani di lavoro prof. cm.80</b> Desktop depth cm.80 <i>Plan de travail cm.80</i></p>	<b>S0300</b>	<b>NCA</b>		80 x 80 x 2,5	1	0,030	12,2	<b>51,00</b>	
	<b>S0301</b>	<b>RM</b>		100 x 80 x 2,5	1	0,038	15,2	<b>64,00</b>	
	<b>S0302</b>	<b>RSB</b>		120 x 80 x 2,5	1	0,045	18,2	<b>76,00</b>	
	<b>S0303</b>	<b>OL</b>		140 x 80 x 2,5	1	0,052	21,3	<b>89,00</b>	
	<b>S0304</b>	<b>GAV</b>		160 x 80 x 2,5	1	0,060	24,3	<b>101,00</b>	
	<b>S0305</b>	<b>GTO</b>		180 x 80 x 2,5	1	0,067	27,4	<b>114,00</b>	
	<b>S0306</b>	<b>BI</b>		200 x 80 x 2,5	1	0,075	30,4	<b>127,00</b>	
 <p><b>Piani di lavoro prof. cm.60</b> Desktop depth cm.80 <i>Plan de travail profondeur cm.80</i></p>	<b>S0310</b>			60 x 60 x 2,5	1	0,017	6,8	<b>29,00</b>	
	<b>S0311</b>	<b>NCA</b>		80 x 60 x 2,5	1	0,023	9,1	<b>38,00</b>	
	<b>S0312</b>	<b>RM</b>		90 x 60 x 2,5	1	0,026	10,3	<b>43,00</b>	
	<b>S0313</b>	<b>RSB</b>		100 x 60 x 2,5	1	0,028	11,4	<b>48,00</b>	
	<b>S0314</b>	<b>OL</b>		120 x 60 x 2,5	1	0,034	13,7	<b>57,00</b>	
	<b>S0315</b>	<b>GAV</b>		140 x 60 x 2,5	1	0,040	16,0	<b>67,00</b>	
	<b>S0316</b>	<b>GTO</b>		160 x 60 x 2,5	1	0,045	18,2	<b>76,00</b>	
	<b>S0317</b>	<b>BI</b>		180 x 60 x 2,5	1	0,051	20,5	<b>86,00</b>	
	<b>S0318</b>				200 x 60 x 2,5	1	0,056	22,8	<b>95,00</b>
	 <p><b>Piano di lavoro sagomato prof. cm.80</b> Shaped desktop depth cm.80 <i>Plan de travail vague profondeur cm.80</i></p>	<b>S0320</b>	<b>NCA</b>		140 x 80 x 2,5	1	0,052	21,3	<b>140,00</b>
<b>S0321</b>		<b>RM</b> <b>RSB</b> <b>OL</b> <b>GAV</b>		160 x 80 x 2,5	1	0,060	24,3	<b>153,00</b>	
<b>S0322</b>		<b>GTO</b> <b>BI</b>		180 x 80 x 2,5	1	0,067	27,4	<b>165,00</b>	
 <p><b>Piano di lavoro sagomato prof. cm.60/80</b> Shaped desktop depth cm.60/80 <i>Plan de travail vague profondeur cm.60/80</i></p>	<b>S0325</b>	<b>NCA</b>		140 x 60/80x2,5	1	0,052	21,3	<b>140,00</b>	
	<b>S0326</b>	<b>RM</b> <b>RSB</b> <b>OL</b> <b>GAV</b>		160 x 60/80x2,5	1	0,060	24,3	<b>153,00</b>	
	<b>S0327</b>	<b>GTO</b> <b>BI</b>		180 x 60/80x2,5	1	0,067	27,4	<b>165,00</b>	
 <p><b>Piano di lavoro angolare L.160 P.140</b> Worktop W.160 D.140 <i>Plan compact L.160 P.140</i></p>	<b>S0330</b>	<b>NCA</b>		160 x 140 x 2,5	1	0,104	42,6	<b>241,00</b>	
	<b>DX-SX</b>	<b>RM</b> <b>RSB</b> <b>OL</b> <b>GAV</b> <b>GTO</b> <b>BI</b>							
 <p><b>Piano di lavoro angolare L.160 P.160</b> Worktop W.160 D.160 <i>Plan compact L.160 P.160</i></p>	<b>S0331</b>	<b>NCA</b>		160 x 160 x 2,5	1	0,118	48,6	<b>266,00</b>	
	<b>DX-SX</b>	<b>RM</b> <b>RSB</b> <b>OL</b> <b>GAV</b> <b>GTO</b> <b>BI</b>							

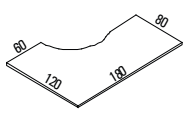
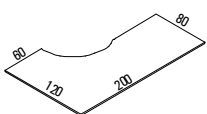
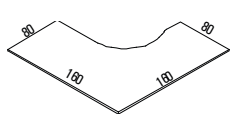
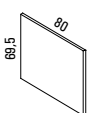
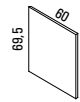
# OPEN WORK

PIANI DI LAVORO OPERATIVE DESKS BUREAUX OPÉRATIONNELS	CODICE CODE CODE	FINITURA PIANI TOP FINISHING FIN. PLANS	L x P x SP. W x D x TH. L x P x EP.	COLLI PACKS COLIS	VOLUMI VOLUME VOLUME	PESO WEIGHT POIDS	PREZZO PRICE PRIX €
 <p><b>DX</b></p> <p><b>Piano di lavoro angolare L.180 P.120</b> Worktop W.180 D.120 <i>Plan compact L.180 P.120</i></p>	<b>S0332 DX-SX</b>	NCA RM RSB OL GAV GTO BI	180 x 120 x 2,5	1	0,100	41,0	<b>235,00</b>
 <p><b>DX</b></p> <p><b>Piano di lavoro angolare L.200 P.120</b> Worktop W.200 D.120 <i>Plan compact L.200 P.120</i></p>	<b>S0334 DX-SX</b>	NCA RM RSB OL GAV GTO BI	200 x 120 x 2,5	1	0,111	45,6	<b>254,00</b>
 <p><b>DX</b></p> <p><b>Piano di lavoro angolare L.160 P.160</b> Worktop W.160 D.160 <i>Plan compact L.160 P.160</i></p>	<b>S0333 DX-SX</b>	NCA RM RSB OL GAV GTO BI	160 x 160 x 2,5	1	0,118	48,6	<b>266,00</b>
GAMBA PANNELLATA PROF.80/60 WOODEN LEG DEPTH 80/60 PIED PANNEAU PROF. 80/60	CODICE CODE CODE	FINITURA FINISHING FINISSAGE	L x P x SP. W x D x TH. L x P x EP.	COLLI PACKS COLIS	VOLUMI VOLUME VOLUME	PESO WEIGHT POIDS	PREZZO PRICE PRIX €
 <p><b>Gamba pannello prof. 80</b> Wooden leg depth 80 <i>Pied panneau profondeur. 80</i></p>	<b>S0001</b>	NCA RM RSB OL GAV GTO BI	80 x 69,5 x 2,5	1	0,027	10,6	<b>44,00</b>
 <p><b>Gamba pannello prof. 60</b> Wooden leg depth 60 <i>Pied panneau profondeur. 60</i></p>	<b>S0001.1</b>	NCA RM RSB OL GAV GTO BI	60 x 69,5 x 2,5	1	0,020	7,9	<b>33,00</b>

## OPEN WORK

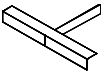
Disponibili in altre finiture: STAFFA e TRAVERSINO (BI-NR); TRAVE (BI-NR-CR). PREZZI DA CALCOLARE  
 Other finishes available for : BRACKET and HOLDING BRACKET (BI-NR); BEAM (BI-NR-CR). PRICES TO BE MADE  
 Des autres finitions pour: ETRIER et ETRIER de SOUTIEN (BI-NR); POUTRE (BI-NR-CR). PRIX A CALCULER

COMPONENTI METALLICI METAL COMPOUNDS COMPOSANTS METALLIQUES	CODICE CODE CODE		FIN. GAMBE LEG FINISHING FINITION PIEDS	L x H. W x H. L x P x H.	COLLI PACKS COLIS	VOLUMI VOLUME VOLUME	PESO WEIGHT POIDS	PREZZO PRICE PRIX €
 <p><b>Staffa aggancio trave per pannelli e cassettiere</b>                      Bracket for beam hooking for panels and drawers  <i>Etrier accrochement poutre pour panneaux et caissons</i></p>	S0020		AL		1	0,031	1,9	46,00
 <p><b>Traversino per gambe singole o per terminali</b>                      Holding bracket for single legs and terminal edges  <i>Etrier de soutien pour pied single ou plans terminales</i></p>	S0022		AL		1	0,000	0,4	16,00
 <p><b>Travi metalliche per piani di lavoro</b>                      Metal beams for working desktops  <i>Poutres métalliques pour plans de travail</i></p>	S0030		AL	L.80	1	0,001	1,1	20,00
	S0031		AL	L.100	1	0,002	1,5	24,00
	S0032		AL	L.120	1	0,002	1,8	27,00
	S0033		AL	L.140	1	0,002	2,1	30,00
	S0034		AL	L.160	1	0,003	2,5	34,00
	S0035		AL	L.180	1	0,003	2,9	36,00
	S0036		AL	L.200	1	0,003	3,3	39,00
	S0037		AL	L.220	1	0,004	3,7	43,00

# OPEN WORK

PANNELLI RIVESTITI IN STOFFA € 198,00 AL MQ.

FABRIC UPHOLSTERED PANEL € 198,00 PER SQUARE METER

CLOISONNETTES REVETUES EN TISSU PRIX POUR METRE CARRE € 198,00

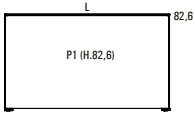
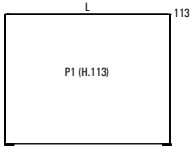
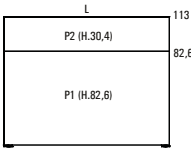
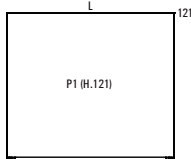

PARETINE CON PROFILO SCREEN WITH PROFILE CLOISONNETTE AVEC PROFIL	CODICE CODE CODE	FINITURA FINISHING FINISSAGE	FIN. PROFILO PROFILR FIN. FIN.PROFIL	L x P x SP. W x D x TH. L x P x EP.	COLLI PACKS COLIS	VOLUMI VOLUME VOLUME	PESO WEIGHT POIDS	PREZZO PRICE PRIX €
 <p><b>Paretina H.82,6 (1 pannello legno)</b> <i>Screen H.82,6 (1 wooden panel)</i> Cloisonette H.82,6 (1 panneau mélaminé)</p>		NCA	AL					
	S0800	RM		60 x 82,6 x 2,5	1	0,024	9,4	114,00
	S0800.1	RSB		80 x 82,6 x 2,5	1	0,031	12,6	129,00
	S0800.2	OL		90 x 82,6 x 2,5	1	0,035	14,1	137,00
	S0800.3	GAV		100 x 82,6 x 2,5	1	0,035	15,7	145,00
	S0800.4	GTO		120 x 82,6 x 2,5	1	0,046	18,8	160,00
	S0800.5	BI		140 x 82,6 x 2,5	1	0,054	22,0	176,00
	S0800.6	RS		160 x 82,6 x 2,5	1	0,062	25,1	197,00
	S0800.7	AZ		180 x 82,6 x 2,5	1	0,069	28,2	212,00
S0800.8	VR	200 x 82,6 x 2,5	1	0,077	31,4	228,00		
	GL							
 <p><b>Paretina H.113 (1 pannello legno)</b> <i>Screen H.113 (1 wooden panel)</i> Cloisonette H.113 (1 panneau mélaminé)</p>		NCA	AL					
	S0801	RM		60 x 113 x 2,5	1	0,032	12,9	133,00
	S0801.1	RSB		80 x 113 x 2,5	1	0,042	17,2	153,00
	S0801.2	OL		90 x 113 x 2,5	1	0,048	19,3	164,00
	S0801.3	GAV		100 x 113 x 2,5	1	0,048	21,5	174,00
	S0801.4	GTO		120 x 113 x 2,5	1	0,063	25,8	194,00
	S0801.5	BI		140 x 113 x 2,5	1	0,073	30,1	215,00
	S0801.6	RS		160 x 113 x 2,5	1	0,084	34,4	241,00
	S0801.7	AZ		180 x 113 x 2,5	1	0,094	38,6	261,00
S0801.8	VR	200 x 113 x 2,5	1	0,105	42,9	281,00		
	GL							
 <p><b>Paretina H.113 (2 pannelli legno)</b> <i>Screen H.113 (2 wooden panels)</i> Cloisonette H.113 (2 panneaux mélaminé)</p>		NCA	AL					
	S0802	RM		60 x 113 x 2,5	1	0,032	12,9	149,00
	S0802.1	RSB		80 x 113 x 2,5	1	0,042	17,2	169,00
	S0802.2	OL		90 x 113 x 2,5	1	0,048	19,3	180,00
	S0802.3	GAV		100 x 113 x 2,5	1	0,048	21,5	190,00
	S0802.4	GTO		120 x 113 x 2,5	1	0,063	25,8	210,00
	S0802.5	BI		140 x 113 x 2,5	1	0,073	30,1	231,00
	S0802.6	RS		160 x 113 x 2,5	1	0,084	34,4	257,00
	S0802.7	AZ		180 x 113 x 2,5	1	0,094	38,6	277,00
S0802.8	VR	200 x 113 x 2,5	1	0,105	42,9	297,00		
	GL							
 <p><b>Paretina H.121 (1 pannello legno)</b> <i>Screen H.121 (1 wooden panel)</i> Cloisonette H.121 (1 panneau mélaminé)</p>		NCA	AL					
	S0803	RM		60 x 121 x 2,5	1	0,034	13,8	138,00
	S0803.1	RSB		80 x 121 x 2,5	1	0,045	18,4	160,00
	S0803.2	OL		90 x 121 x 2,5	1	0,051	20,7	171,00
	S0803.3	GAV		100 x 121 x 2,5	1	0,051	23,0	182,00
	S0803.4	GTO		120 x 121 x 2,5	1	0,068	27,6	203,00
	S0803.5	BI		140 x 121 x 2,5	1	0,079	32,2	225,00
	S0803.6	RS		160 x 121 x 2,5	1	0,090	36,8	252,00
	S0803.7	AZ		180 x 121 x 2,5	1	0,101	41,4	274,00
S0803.8	VR	200 x 121 x 2,5	1	0,112	46,0	295,00		
	GL							

# OPEN WORK

## PANNELLI RIVESTITI IN STOFFA € 198,00 AL MQ.

FABRIC UPHOLSTERED PANEL € 198,00 PER SQUARE METER

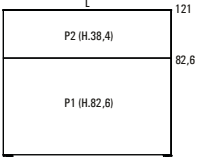
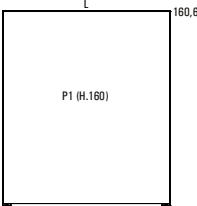
CLOISONNETTES REVETUES EN TISSU PRIX POUR METRE CARRE € 198,00

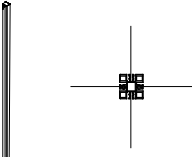
PARETINE CON PROFILO SCREEN WITH PROFILE CLOISONNETTE AVEC PROFIL	CODICE CODE CODE	FINITURA FINISHING FINISSAGE	FIN. PROFILO PROFILR FIN. FIN.PROFIL	L x P x SP. W x D x TH. L x P x EP.	COLLI PACKS COLIS	VOLUMI VOLUME VOLUME	PESO WEIGHT POIDS	PREZZO PRICE PRIX €
 <p><b>Paretina H.121 (2 pannelli legno)</b> <i>Screen H.121 (2 wooden panels)</i> Cloisonette H.121 (2 panneaux mélaminé)</p>	S0804	NCA	AL	60 x 121 x 2,5	1	0,034	13,8	154,00
	S0804.1	RM		80 x 121 x 2,5	1	0,045	18,4	176,00
	S0804.2	RSB		90 x 121 x 2,5	1	0,051	20,7	187,00
	S0804.3	OL		100 x 121 x 2,5	1	0,051	23,0	198,00
	S0804.4	GAV		120 x 121 x 2,5	1	0,068	27,6	219,00
	S0804.5	GTO		140 x 121 x 2,5	1	0,079	32,2	241,00
	S0804.6	BI		160 x 121 x 2,5	1	0,090	36,8	268,00
	S0804.7	RS		180 x 121 x 2,5	1	0,101	41,4	290,00
	S0804.8	AZ		200 x 121 x 2,5	1	0,112	46,0	311,00
 <p><b>Paretina H.160,6 (1 pannello legno)</b> <i>Screen H.160,6 (1 wooden panel)</i> Cloisonette H.160,6 (1 panneau mélaminé)</p>	S0805	NCA	AL	60 x 160,6 x 2,5	1	0,045	18,4	164,00
	S0805.1	RM		80 x 160,6 x 2,5	1	0,060	24,5	192,00
	S0805.2	RSB		90 x 160,6 x 2,5	1	0,067	27,5	207,00
	S0805.3	OL		100 x 160,6 x 2,5	1	0,067	30,6	220,00
	S0805.4	GAV		120 x 160,6 x 2,5	1	0,089	36,7	248,00
	S0805.5	GTO		140 x 160,6 x 2,5	1	0,104	42,8	276,00
	S0805.6	BI		160 x 160,6 x 2,5	1	0,119	48,9	310,00
	S0805.7	RS		180 x 160,6 x 2,5	1	0,133	55,1	337,00
	S0805.8	AZ		200 x 160,6 x 2,5	1	0,148	61,2	365,00
 <p><b>Profilo di giunzione per paretine</b> <i>Juction profile for screens</i> Profil central de liaison pour cloisonnettes</p>	S0810		AL	H.82,6	1	0,006	0,5	3,00
	S0810.1			H.113	1	0,008	0,5	3,50
	S0810.2			H.121	1	0,009	0,5	4,00
	S0810.3			H.160,6	1	0,010	0,5	5,00
 <p><b>Profilo per angolo 2-3-4 vie a 90°/180° per paretine</b> <i>Angle profile 2-3-4 ways at 90°/180° for screens</i> Profil pour angle 2-3-4 voies à 90°/180° pour cloisonnettes</p>	S0815		AL	H.82,6	1	0,006	1,0	15,00
	S0815.1			H.113	1	0,008	1,0	19,00
	S0815.2			H.121	1	0,009	1,0	21,00
	S0815.3			H.160,6	1	0,010	1,0	28,00

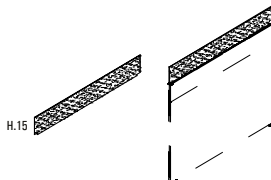
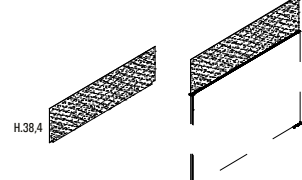

# OPEN WORK

COMPONENTI PER PARETINE COMPOUNDS FOR SCREENS COMPOSANTS POUR CLOISONNETTES	CODICE CODE CODE	FINITURA FINISHING FINISSAGE	L x P x SP. W x D x TH. L x P x EP.	COLLI PACKS COLIS	VOLUMI VOLUME VOLUME	PESO WEIGHT POIDS	PREZZO PRICE PRIX €		
 <p><b>Pannello superiore in plexiglass per paretine</b> <i>Plexi upper panel for screens</i> <b>Panneau supérieur en plexi pour cloisonnettes</b></p>	<b>S0820</b>	<b>BI RS GL BT</b>	60 x 15 x 0,3	1	0,002	0,4	<b>24,00</b>		
	<b>S0820.1</b>		80 x 15 x 0,3	1	0,003	0,5	<b>29,00</b>		
	<b>S0820.2</b>		90 x 15 x 0,3	1	0,003	0,5	<b>31,00</b>		
	<b>S0820.3</b>		100 x 15 x 0,3	1	0,003	0,6	<b>33,00</b>		
	<b>S0820.4</b>		120 x 15 x 0,3	1	0,004	0,7	<b>38,00</b>		
	<b>S0820.5</b>		140 x 15 x 0,3	1	0,005	0,8	<b>42,00</b>		
	<b>S0820.6</b>		160 x 15 x 0,3	1	0,005	1,0	<b>47,00</b>		
	<b>S0820.7</b>		180 x 15 x 0,3	1	0,006	1,1	<b>51,00</b>		
	<b>S0820.8</b>		200 x 15 x 0,3	1	0,006	1,2	<b>56,00</b>		
 <p><b>Pannello superiore in plexiglass per paretine</b> <i>Plexi upper panel for screens</i> <b>Panneau supérieur en plexi pour cloisonnettes</b></p>	<b>S0825</b>	<b>BI RS GL BT</b>	60 x 38,4 x 0,3	1	0,005	0,9	<b>45,00</b>		
	<b>S0825.1</b>		80 x 38,4 x 0,3	1	0,007	1,2	<b>56,00</b>		
	<b>S0825.2</b>		90 x 38,4 x 0,3	1	0,007	1,4	<b>62,00</b>		
	<b>S0825.3</b>		100 x 38,4 x 0,3	1	0,008	1,5	<b>68,00</b>		
	<b>S0825.4</b>		120 x 38,4 x 0,3	1	0,010	1,8	<b>80,00</b>		
	<b>S0825.5</b>		140 x 38,4 x 0,3	1	0,011	2,2	<b>91,00</b>		
	<b>S0825.6</b>		160 x 38,4 x 0,3	1	0,013	2,5	<b>103,00</b>		
	<b>S0825.7</b>		180 x 38,4 x 0,3	1	0,015	2,8	<b>114,00</b>		
			<b>S0825.8</b>		200 x 38,4 x 0,3	1	0,016	3,1	<b>126,00</b>

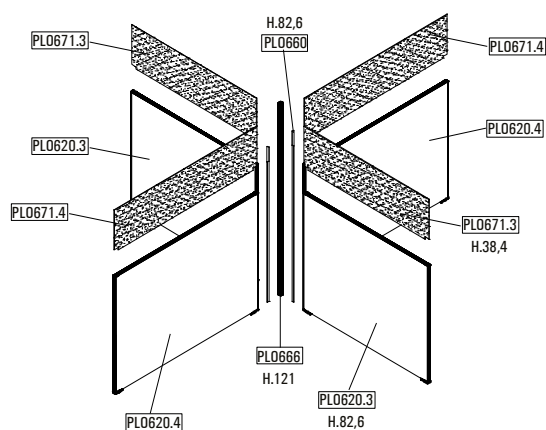

Art. N°2 PL0620.3+2 PL0620.4+2 PL0671.3+  
2 PL0671.4+4 PL0666+ 1 PL0666

# OPEN WORK

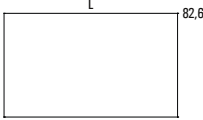
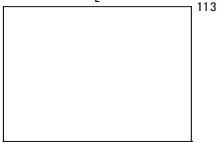
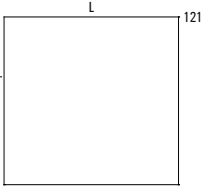
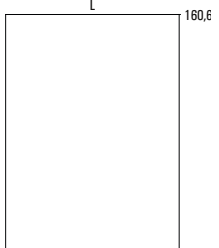
PARETINE SENZA PROFILO SCREEN WITHOUT PROFILE CLOISONETTE SANS PROFIL	CODICE CODE CODE	FINITURA FINISHING FINISSAGE		L x P x SP.	COLLI	VOLUMI	PESO	PREZZO
				W x D x TH.	PACKS	VOLUME	WEIGHT	PRICE
				L x P x EP.	COLIS	VOLUME	POIDS	PRIX
								€
 <p><b>Paretina H.82,6</b> <i>Screen H.82,6</i> Cloisonette H.82,6</p>		NCA						
	<b>S0830</b>	RM		60 x 82,6 x 2,5	2	0,024	10,1	<b>81,00</b>
	<b>S0830.1</b>	RSB		80 x 82,6 x 2,5	2	0,032	12,6	<b>94,00</b>
	<b>S0830.2</b>	OL		90 x 82,6 x 2,5	2	0,036	14,1	<b>100,00</b>
	<b>S0830.3</b>	GAV		100 x 82,6 x 2,5	2	0,036	15,7	<b>107,00</b>
	<b>S0830.4</b>	GTO		120 x 82,6 x 2,5	2	0,047	18,8	<b>120,00</b>
	<b>S0830.5</b>	BI		140 x 82,6 x 2,5	2	0,055	22,0	<b>133,00</b>
	<b>S0830.6</b>	RS		160 x 82,6 x 2,5	2	0,063	25,1	<b>152,00</b>
	<b>S0830.7</b>	AZ		180 x 82,6 x 2,5	2	0,070	28,2	<b>165,00</b>
	<b>S0830.8</b>	VR		200 x 82,6 x 2,5	2	0,078	31,4	<b>178,00</b>
		GL						
 <p><b>Paretina H.113</b> <i>Screen H.113</i> Cloisonette H.113</p>		NCA						
	<b>S0831</b>	RM		60 x 113 x 2,5	2	0,033	13,6	<b>95,00</b>
	<b>S0831.1</b>	RSB		80 x 113 x 2,5	2	0,043	17,9	<b>113,00</b>
	<b>S0831.2</b>	OL		90 x 113 x 2,5	2	0,048	20,0	<b>122,00</b>
	<b>S0831.3</b>	GAV		100 x 113 x 2,5	2	0,048	22,2	<b>131,00</b>
	<b>S0831.4</b>	GTO		120 x 113 x 2,5	2	0,064	26,5	<b>149,00</b>
	<b>S0831.5</b>	BI		140 x 113 x 2,5	2	0,074	30,8	<b>166,00</b>
	<b>S0831.6</b>	RS		160 x 113 x 2,5	2	0,085	35,1	<b>190,00</b>
	<b>S0831.7</b>	AZ		180 x 113 x 2,5	2	0,095	39,3	<b>208,00</b>
	<b>S0831.8</b>	VR		200 x 113 x 2,5	2	0,105	43,6	<b>226,00</b>
		GL						
 <p><b>Paretina H.121</b> <i>Screen H.121</i> Cloisonette H.121</p>		NCA						
	<b>S0832</b>	RM		60 x 121 x 2,5	2	0,035	14,5	<b>99,00</b>
	<b>S0832.1</b>	RSB		80 x 121 x 2,5	2	0,046	19,1	<b>118,00</b>
	<b>S0832.2</b>	OL		90 x 121 x 2,5	2	0,052	21,4	<b>128,00</b>
	<b>S0832.3</b>	GAV		100 x 121 x 2,5	2	0,052	23,7	<b>137,00</b>
	<b>S0832.4</b>	GTO		120 x 121 x 2,5	2	0,068	28,3	<b>156,00</b>
	<b>S0832.5</b>	BI		140 x 121 x 2,5	2	0,079	32,9	<b>175,00</b>
	<b>S0832.6</b>	RS		160 x 121 x 2,5	2	0,091	37,5	<b>200,00</b>
	<b>S0832.7</b>	AZ		180 x 121 x 2,5	2	0,102	42,1	<b>219,00</b>
	<b>S0832.8</b>	VR		200 x 121 x 2,5	2	0,113	46,7	<b>239,00</b>
		GL						
 <p><b>Paretina H.160,6</b> <i>Screen H.160,6</i> Cloisonette H.160,6</p>		NCA						
	<b>S0833</b>	RM		60 x 160,6 x 2,5	2	0,046	19,1	<b>118,00</b>
	<b>S0833.1</b>	RSB		80 x 160,6 x 2,5	2	0,061	25,2	<b>143,00</b>
	<b>S0833.2</b>	OL		90 x 160,6 x 2,5	2	0,068	28,2	<b>156,00</b>
	<b>S0833.3</b>	GAV		100 x 160,6 x 2,5	2	0,068	31,3	<b>169,00</b>
	<b>S0833.4</b>	GTO		120 x 160,6 x 2,5	2	0,090	37,4	<b>194,00</b>
	<b>S0833.5</b>	BI		140 x 160,6 x 2,5	2	0,105	43,5	<b>219,00</b>
	<b>S0833.6</b>	RS		160 x 160,6 x 2,5	2	0,120	49,6	<b>251,00</b>
	<b>S0833.7</b>	AZ		180 x 160,6 x 2,5	2	0,134	55,8	<b>276,00</b>
	<b>S0833.8</b>	VR		200 x 160,6 x 2,5	2	0,149	61,9	<b>302,00</b>
		GL						

# OPEN WORK

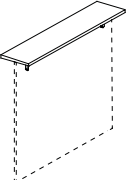
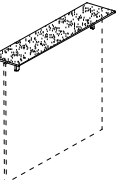
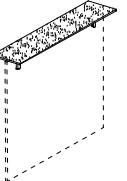
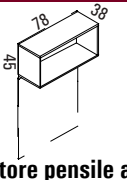
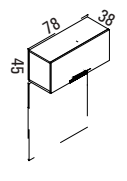
MENSOLE SHELVES TABLETTES	CODICE CODE CODE	FINITURA FINISHING FINISSAGE		L x P x SP. W x D x TH. L x P x EP.	COLLI PACKS COLIS	VOLUMI VOLUME VOLUME	PESO WEIGHT POIDS	PREZZO PRICE PRIX €
 <p><b>Mensola legno</b> Wooden shelf Tablette mélaminé</p>	S0840	NCA RM		60 x 30 x 2,5	2	0,009	1,1	40,00
	S0840.1	RSB		80 x 30 x 2,5	2	0,012	1,4	45,00
	S0840.2	OL		90 x 30 x 2,5	2	0,013	1,6	48,00
	S0840.3	GAV		100 x 30 x 2,5	2	0,015	1,8	50,00
	S0840.4	GTO		120 x 30 x 2,5	2	0,018	2,2	55,00
	S0840.5	BI		140 x 30 x 2,5	2	0,020	2,5	59,00
	S0840.6	RS		160 x 30 x 2,5	2	0,023	2,9	64,00
	S0840.7	AZ		180 x 30 x 2,5	2	0,026	3,2	69,00
	S0840.8	VR		200 x 30 x 2,5	2	0,029	3,6	74,00
			GL					
 <p><b>Mensola in vetro bisatinato</b> Glass shelf Tablette en verre</p>	S0850			60 x 30 x 1,2	2	0,014	5,8	319,00
	S0850.1			80 x 30 x 1,2	2	0,019	7,7	348,00
	S0850.2			90 x 30 x 1,2	2	0,021	8,6	361,00
	S0850.3			100 x 30 x 1,2	2	0,023	9,6	368,00
	S0850.4	VS		120 x 30 x 1,2	2	0,027	11,5	404,00
	S0850.5			140 x 30 x 1,2	2	0,032	13,4	424,00
	S0850.6			160 x 30 x 1,2	2	0,036	15,4	447,00
	S0850.7			180 x 30 x 1,2	2	0,040	17,3	483,00
	S0850.8			200 x 30 x 1,2	2	0,044	19,2	501,00
 <p><b>Mensola in vetro colorato</b> Coloured glass shelf Tablette en verre</p>	S0855			60 x 30 x 1,2	2	0,014	5,8	352,00
	S0855.1			80 x 30 x 1,2	2	0,019	7,7	391,00
	S0855.2	VN		90 x 30 x 1,2	2	0,021	8,6	411,00
	S0855.3	VB		100 x 30 x 1,2	2	0,023	9,6	422,00
	S0855.4	VC		120 x 30 x 1,2	2	0,027	11,5	469,00
	S0855.5	VR		140 x 30 x 1,2	2	0,032	13,4	501,00
	S0855.6			160 x 30 x 1,2	2	0,036	15,4	532,00
	S0855.7			180 x 30 x 1,2	2	0,040	17,3	577,00
	S0855.8			200 x 30 x 1,2	2	0,044	19,2	609,00
CONTENITORI PENSILE HANGING CABINTES MEUBLES SUSPENDU	CODICE CODE CODE	FIN. ANTE DOORS FINISHING FIN. PORTES	FIN. SCOCCA STRUCTURE FINISHING FIN. STRUCT.	L x P x SP. W x D x TH. L x P x EP.	COLLI PACKS COLIS	VOLUMI VOLUME VOLUME	PESO WEIGHT POIDS	PREZZO PRICE PRIX €
 <p><b>Contenitore pensile a giorno</b> Hanging cabinet Meuble suspendu à jour</p>	S0880		AL		1	0,160	16,0	102,00
			BI					
			NR					
			GA					
 <p><b>Contenitore pensile con anta a ribalta</b> Hanging cabinet with flapping door Meuble suspendu avec porte à abattant</p>	S0881	NCA	AL		1	0,160	22,0	181,00
		RM	BI					
		RSB						
		OL						
		GAV						
		GTO	NR					
		BI						
		RS						
		AZ						
		VR	GA					
GL								



## STUDIO OFFICE

### SMART ACCESSORI

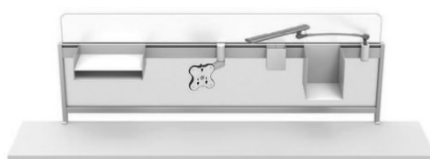
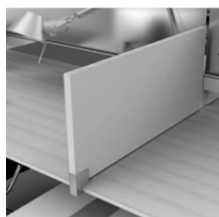
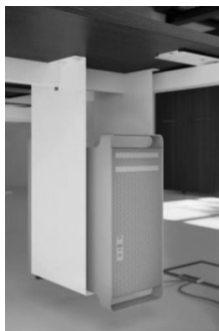

### SMART ACCESSORI

La linea smart accessori è composta da: sottomani in pelle e ecopelle di diverse misure, pannelli frontali laterali e centrali in legno, rivestiti in stoffa e fonoassorbenti.

### SMART ACCESSORIES

Smart accessory line is composed of leather and eco leather hand pads; central, side, frontal wooden panels. Fabric upholstered and sound proof.

### SMART ACCESSOIRES

Smart accessoires se compose de soumains en cuir/similcui de différentes dimensions, écrans mélaminés, revetus en tissu ou insonorisant.

## SMART ACCESSORI

PER MODELLI: DIVO-DELUXE-TRILOGY-QUADRA-TAU

FOR LINES: DIVO-DELUXE-TRILOGY-QUADRA-TAU

POUR GAMMES: DIVO-DELUXE-TRILOGY-QUADRA-TAU

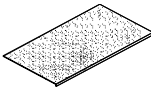
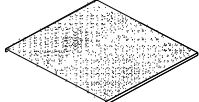
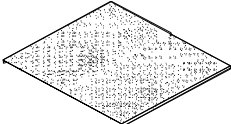
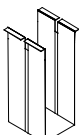
SOTTOMANI E PORTA PC WORKIN PAD AND CPU HOLDER SOUS-MAINS ET PORTE PC	CODICE CODE CODE	FINITURA FINISHING FINISSAGE	L x P x SP. W x D x TH. L x P x EP.	COLLI PACKS COLIS	VOLUMI VOLUME VOLUME	PESO WEIGHT POIDS	PREZZO
							PRICE PRIX €
 <b>Sottomano in pelle</b> <i>Leather working pad</i> Sous-main en cuir	AC300	E	85 x 46,7 x Sp.0,2	1	0,015	4,0	189,00
	AC300.1	P					298,00
 <b>Sottomano in pelle Prof.80</b> <i>Leather working pad depth 80</i> Sous-main en cuir profondeur 80	AC301	E	70 x 80 x Sp.0,2	1	0,017	7,0	200,00
	AC301.1	P					328,00
 <b>Sottomano in pelle Prof.90</b> <i>Leather working pad depth 90</i> Sous-main en cuir profondeur 90	AC302	E	80 x 90 x Sp.0,2	1	0,022	9,0	216,00
	AC302.1	P					388,00
 <b>Porta pc con aggancio sotto al piano</b> <i>Cpu holding shelf to be fixed under the top</i> Porte pc avec accrochement sous le plateau	AC350	AL BI NR GA	22 x 55	1	0,037	5,4	60,00

## SMART ACCESSORI

PER MODELLI:QUADRA-TAU. SPECIFICARE SEMPRE COLORE PROFILO (AL-BI)  
 FOR LINES: QUADRA-TAU. ALWAYS SPECIFY PROFILE COLOUR (AL-BI)  
 POUR GAMMES: QUADRA-TAU. SPECIFIER TOUJOURS LR COLEUR DU PROFIL (AL-BI)

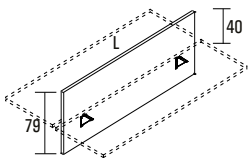
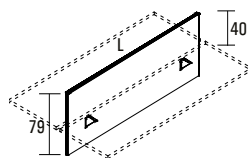
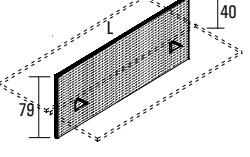
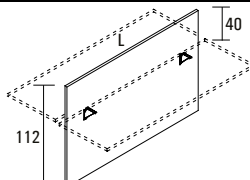
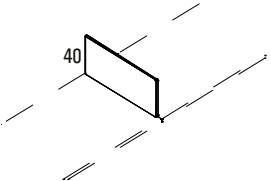
PANNELLI E PARETINE FRONTALI/CENTRALI FRONTAL PANELS PANNEAUX FRONTALES	CODICE CODE CODE	FINITURA FINISHING FINISSAGE	FIN. STAFFA FIN. BRACKET FIN. SUPPORT	L x P x SP. W x D x TH. L x P x EP.	COLLI PACKS COLIS	VOLUMI VOLUME VOLUME	PESO WEIGHT POIDS	PREZZO PRICE PRIX €
	 <p><b>Pannello frontale/centrale senza profilo</b>  <i>Frontal/central panel without profile</i>                      Panneau frontale/centrale sans profil</p>		NCA	AL				
S0610		RM	68 x 79 x 2,5		1	0,026	10,2	76,00
S0611		RSB	88 x 79 x 2,5		1	0,033	13,2	89,00
S0612		OL	108 x 79 x 2,5		1	0,033	16,2	101,00
S0613		GAV	128 x 79 x 2,5		1	0,033	19,2	114,00
S0614		GTO	148 x 79 x 2,5		1	0,033	22,2	126,00
S0615		BI	168 x 79 x 2,5		1	0,033	25,2	139,00
S0616		RS	188 x 79 x 2,5		1	0,033	28,2	151,00
 <p><b>Pannello frontale/centrale con profilo</b>  <i>Frontal/central panel with profile</i>                      Panneau frontale/centrale avec profil</p>		NCA	AL					
	S0610.1	RM		68 x 79 x 2,5	1	0,026	10,2	117,00
	S0611.1	RSB		88 x 79 x 2,5	1	0,033	13,2	131,00
	S0612.1	OL		108 x 79 x 2,5	1	0,033	16,2	146,00
	S0613.1	GAV		128 x 79 x 2,5	1	0,033	19,2	161,00
	S0614.1	GTO		148 x 79 x 2,5	1	0,033	22,2	176,00
	S0615.1	BI		168 x 79 x 2,5	1	0,033	25,2	191,00
	S0616.1	RS		188 x 79 x 2,5	1	0,033	28,2	205,00
 <p><b>Pannello frontale/centrale rivestito in stoffa con profilo</b>  <i>Frontal/central fabric upholstered panel with profile</i>                      Panneau frontale/centrale avec profil revêtu en tissu</p>		NCA	AL					
	S0610.2	RM		68 x 79 x 2,5	1	0,026	10,2	253,00
	S0611.2	RSB		88 x 79 x 2,5	1	0,033	13,2	278,00
	S0612.2	OL		108 x 79 x 2,5	1	0,033	16,2	293,00
	S0613.2	GAV		128 x 79 x 2,5	1	0,033	19,2	307,00
	S0614.2	GTO		148 x 79 x 2,5	1	0,033	22,2	414,00
	S0615.2	BI		168 x 79 x 2,5	1	0,033	25,2	455,00
	S0616.2	RS		188 x 79 x 2,5	1	0,033	28,2	500,00
 <p><b>Paretina frontale/centrale senza profilo</b>  <i>Frontal/central screen without profile</i>                      Cloisonette frontale/centrale sans profil</p>		NCA	AL					
	S0620	RM		68 x 112 x 2,5	1	0,026	14,5	94,00
	S0621	RSB		88 x 112 x 2,5	1	0,033	18,7	112,00
	S0622	OL		108 x 112 x 2,5	1	0,033	23,0	129,00
	S0623	GAV		128 x 112 x 2,5	1	0,033	27,2	147,00
	S0624	GTO		148 x 112 x 2,5	1	0,033	31,5	165,00
	S0625	BI		168 x 112 x 2,5	1	0,033	35,8	182,00
	S0626	RS		188 x 112 x 2,5	1	0,033	40,0	200,00
 <p><b>Pannello laterale condiviso senza profilo</b>  <i>Shared lateral panels without profile</i>                      Panneau partagé latérale sans profil</p>	S0630	NCA RM RSB OL GAV GTO	AL	60 x 40 x 2,5	2	0,012	4,6	50,00
	S0630.1	BI RS AZ VR GL	NR GA	80 x 40 x 2,5	2	0,015	6,1	56,00

## SMART ACCESSORI

PER MODELLI: TRILOGY-QUADRA. SPECIFICARE SEMPRE COLORE PROFILO (AL-BI)  
 FOR LINES: TRILOGY-QUADRA. ALWAYS SPECIFY PROFILE COLOUR (AL-BI)  
 POUR GAMMES: TRILOGY-QUADRA. SPECIFIER TOUJOURS LR COLEUR DU PROFIL (AL-BI)

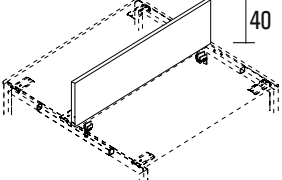
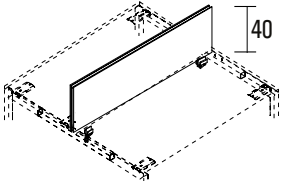
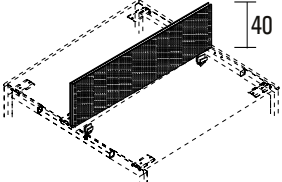
PANNELLI CENTRALI CENTRAL PANELS PANNEAUX CENTRALES	CODICE CODE CODE	FINITURA FINISHING FINISSAGE	FIN. STAFFA FIN. BRACKET FIN. SUPPORT	L x P x SP. W x D x TH. L x P x EP.	COLLI PACKS COLIS	VOLUMI VOLUME VOLUME	PESO WEIGHT POIDS	PREZZO PRICE PRIX €	
	 <p><b>Pannello centrale legno senza profilo con aggancio sulle gambe</b>  <i>Wooden central panel without profile to be fixed on the legs</i>                      Panneau centrale mélaminé sans profil à fixer sur pieds</p>		NCA	AL					
S0650		RM							
S0651		RSB	80 x 42,2 x 2,5		2	0,017	7,1	<b>79,00</b>	
S0652		OL	100 x 42,2 x 2,5		2	0,020	8,7	<b>86,00</b>	
S0653		GAV	120 x 42,2 x 2,5		2	0,024	10,3	<b>93,00</b>	
S0654		GTO	140 x 42,2 x 2,5		2	0,028	11,9	<b>99,00</b>	
S0655		BI	160 x 42,2 x 2,5		2	0,032	13,5	<b>106,00</b>	
S0656		RS	180 x 42,2 x 2,5		2	0,036	15,1	<b>113,00</b>	
S0656		AZ	200 x 42,2 x 2,5		2	0,040	16,7	<b>119,00</b>	
 <p><b>Pannello centrale legno con profilo con aggancio sulle gambe</b>  <i>Wooden central panel with profile to be fixed on the legs</i>                      Panneau centrale mélaminé avec profil à fixer sur pieds</p>		NCA	AL						
		RM							
	S0650.1	RSB		80 x 42,2 x 2,5	2	0,017	7,1	<b>115,00</b>	
	S0651.1	OL		100 x 42,2 x 2,5	2	0,020	8,7	<b>124,00</b>	
	S0652.1	GAV		120 x 42,2 x 2,5	2	0,024	10,3	<b>133,00</b>	
	S0653.1	GTO		140 x 42,2 x 2,5	2	0,028	11,9	<b>142,00</b>	
	S0654.1	BI		160 x 42,2 x 2,5	2	0,032	13,5	<b>150,00</b>	
	S0655.1	RS		180 x 42,2 x 2,5	2	0,036	15,1	<b>159,00</b>	
	S0656.1	AZ		200 x 42,2 x 2,5	1	0,040	16,7	<b>168,00</b>	
 <p><b>Pannello centrale rivestito in stoffa con profilo con aggancio sulle gambe</b>  <i>Wooden central panel upholstered in fabric with profile to be fixed on the legs</i>                      Panneau centrale en tissu avec profil à fixer sur pieds</p>			AL						
	S0650.2			80 x 42,2 x 2,5	2	0,017	7,1	<b>232,00</b>	
	S0651.2	GR (629)		100 x 42,2 x 2,5	2	0,020	8,7	<b>243,00</b>	
	S0652.2	AV (532)		120 x 42,2 x 2,5	2	0,024	10,3	<b>254,00</b>	
	S0653.2	RS (236)		140 x 42,2 x 2,5	2	0,028	11,9	<b>296,00</b>	
	S0654.2	GL (53)		160 x 42,2 x 2,5	2	0,032	13,5	<b>318,00</b>	
	S0655.2	VR (425)		180 x 42,2 x 2,5	2	0,036	15,1	<b>340,00</b>	
	S0656.2	BL (386)		200 x 42,2 x 2,5	2	0,040	16,7	<b>366,00</b>	



## SMART ACCESSORI

PER MODELLI: DELUXE-TRIOLOGY-QUADRA-TAU.

FOR LINES: DELUXE-TRIOLOGY-QUADRA-TAU

POUR GAMMES: DELUXE-TRIOLOGY-QUADRA-TAU

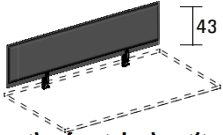
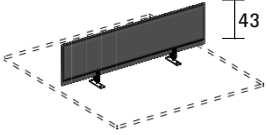
PANNELLI ACUSTICI FRONTALI E LATERALI FRONTAL AND LATERAL ACOUSTIC PANELS PANNEAUX FRONTALES ET LATERALE INSONORISANT	CODICE CODE CODE	FINITURA FINISHING FINISSAGE	FIN. STAFFA FIN. BRACKET FIN. SUPPORT	L x P x SP. W x D x TH. L x P x EP.	COLLI PACKS COLIS	VOLUMI VOLUME VOLUME	PESO WEIGHT POIDS	PREZZO PRICE PRIX €	
	 <p><b>Pannello acustico frontale rivestito in stoffa con aggancio sotto al piano</b> <i>Frontal acoustic panel upholstered in fabric to be fixed under the top</i> Panneau frontale insonorisant en tissu à fixer sous-plan</p>		GR (629)	AL					
S0640		AV (532)	80 x 39 x 2,5		2	0,016	7,5	261,00	
S0642		RS (236)	BI		120 x 39 x 3	2	0,023	10,7	322,00
S0643		GL (53)			140 x 39 x 3	2	0,027	12,4	385,00
S0644		VR (425)	NR		160 x 39 x 3	2	0,031	14,0	417,00
		BL (386)							
 <p><b>Pannello acustico centrale/laterale rivestito in stoffa con aggancio sotto al piano</b> <i>Side/central acoustic panel upholstered in fabric to be fixed under the top</i> Panneau laterale/centrale insonorisant en tissu à fixer sous-plan</p>		GR (629)	AL						
	S0640C	AV (532)		80 x 39 x 3	2	0,016	8,4	323,00	
	S0642C	RS (236)		BI	120 x 39 x 3	2	0,024	11,6	384,00
	S0643C	GL (53)			140 x 39 x 3	2	0,028	13,3	447,00
	S0644C	VR (425)		NR	160 x 39 x 3	2	0,031	14,9	479,00
		BL (386)							

### CARATTERISTICHE

Parete fonoassorbenti con materiale interno composto da fibra di poliestere termoformata a densità variabile. Rivestimento tessuto trevira CS 100%. Resistenza abrasione e solidità alla luce. Lo speciale sistema di taglio e finitura dei bordi dona perfetta simmetria al pannello rendendolo idoneo ad un utilizzo sia su postazioni singole che su postazioni condivise. Il pannello è dotato di una fascia sottostante di materiale ad alta densità che conferisce rigidità al sistema e ne permette il fissaggio tramite un morsetto che stringa solo la parte inferiore, senza bisogno di utilizzare supporti invasivi. È un prodotto ecologico ottenuto da materiale riciclato e a sua volta riciclabile.

### CHARACTERISTICS



Acoustic panel with inside material thermoformed polyester fibre with variable density. External fabric MIRAGE C5 100% polyester. Abrasion resistance and light fastness. The special cutting and finishing of the edges bestows perfect symmetry on the panel, making suitable for the use as well on single and shared workstation. The panel is equipped with a lower band of high-density material that provides rigidity to the system and allows fastening just with a clamp on the lower section, without needing for invasive supports.

It is a eco-friendly product as it is produced with recycled and recyclable material.

### CARATTERISTICHE

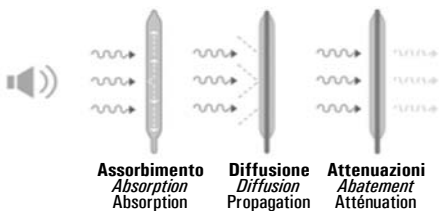
Cloison phonique composée intérieurement de matériaux en fibre de polyester thermoformé à densité variable. Revêtement en tissu Trevira CS 100%. Résistant à l'abrasion et à la lumière. Le système spécial de coupe et de finition des bords accordent une parfaite symétrie au panneau qui par cela est capable de s'adapter aussi bien pour des postes de travail individuel ou en équipe. Le panneau est équipé d'une gaine sous-jacente de matériaux à haute densité qui permet au système une certaine solidité et fixation au moyen d'un étau qui serre seulement la partie inférieure, sans le besoin d'utiliser des supports volumineux. Ce produit est écologique ayant été obtenu à partir de matériaux recyclés et qui de même peut l'être.

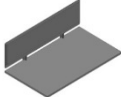
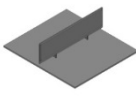

Pannello frontale-Frontal panel -Panneau frontale	Pannello centrale-Central panel -Panneau frontale	Pannello central/laterale-Central/lateral panel -Panneau centrale/frontale
		

## SMART ACCESSORI

PER MODELLI: DELUXE-TRILOGY-QUADRA-TAU. SPECIFICARE SEMPRE COLORE PROFILO (AL-BI)  
 FOR LINES: DELUXE-TRILOGY-QUADRA-TAU. ALWAYS SPECIFY PROFILE COLOUR (AL-BI)  
 POUR GAMMES: DELUXE-TRILOGY-QUADRA-TAU. SPECIFIER TOUJOURS LR COULEUR DU PROFIL (AL-BI)

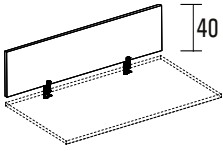
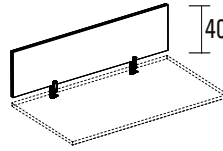
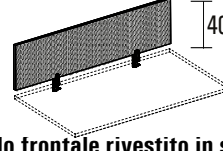
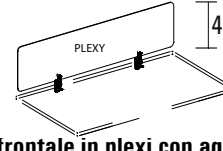
PANNELLI FRONTALI FRONTAL PANELS PANNEAUX FRONTALES	CODICE CODE CODE	FINITURA FINISHING FINISSAGE	FIN. STAFFA FIN. BRACKET FIN. SUPPORT	L x P x SP. W x D x TH. L x P x EP.	COLLI PACKS COLIS	VOLUMI VOLUME VOLUME	PESO WEIGHT POIDS	PREZZO PRICE PRIX €
 <p><b>Pannello frontale senza profilo e aggancio sotto al piano</b>  <i>Frontal panel without profile to be fixed under the top</i>            Panneau frontale sans profil à fixer sous-plan</p>		NCA						
	S0660	RM		80 x 36 x 2,5	2	0,015	6,4	86,00
	S0661	RSB		100 x 36 x 2,5	2	0,018	7,7	91,00
	S0662	OL		120 x 36 x 2,5	2	0,022	9,1	97,00
	S0663	GAV		140 x 36 x 2,5	2	0,025	10,5	103,00
	S0664	GTO		160 x 36 x 2,5	2	0,028	11,8	108,00
	S0665	BI		180 x 36 x 2,5	2	0,032	13,2	114,00
	S0666	RS		200 x 36 x 2,5	2	0,035	14,6	120,00
		AZ						
	VR							
	GL							
 <p><b>Pannello frontale con profilo e aggancio sotto al piano</b>  <i>Frontal panel with profile to be fixed under the top</i>            Panneau frontale avec profil à fixer sous-plan</p>		NCA						
	S0660.1	RM		80 x 36 x 2,5	2	0,015	6,4	120,00
	S0661.1	RSB		100 x 36 x 2,5	2	0,018	7,7	128,00
	S0662.1	OL		120 x 36 x 2,5	2	0,022	9,1	136,00
	S0663.1	GAV		140 x 36 x 2,5	2	0,025	10,5	144,00
	S0664.1	GTO		160 x 36 x 2,5	2	0,028	11,8	152,00
	S0665.1	BI		180 x 36 x 2,5	2	0,032	13,2	160,00
	S0666.1	RS		200 x 36 x 2,5	2	0,035	14,6	168,00
		AZ						
	VR							
	GL							
 <p><b>Pannello frontale rivestito in stoffa con profilo e aggancio sotto al piano</b>  <i>Frontal panel upholstered in fabric with profile to be fixed under the top</i>            Panneau frontale en tissu avec profil à fixer sous-plan</p>		GR (629)						
	S0660.2	AV (532)		80 x 36 x 2,5	2	0,015	6,4	208,00
	S0661.2	RS (236)		100 x 36 x 2,5	2	0,018	7,7	229,00
	S0662.2	GL (53)		120 x 36 x 2,5	2	0,022	9,1	250,00
	S0663.2	VR (425)		140 x 36 x 2,5	2	0,025	10,5	266,00
	S0664.2	BL (386)		160 x 36 x 2,5	2	0,028	11,8	287,00
	S0665.2			180 x 36 x 2,5	2	0,032	13,2	308,00
	S0666.2			200 x 36 x 2,5	2	0,035	14,6	329,00
 <p><b>Pannello frontale in plexi con aggancio sotto al piano</b>  <i>Plexy frontal panel to be fixed under the top</i>            Panneau frontale en plexy avec fixer sous-plan</p>								
	S0660.3	BI		80 x 36 x 0,5	2	0,001	2,6	141,00
	S0661.3	RS		100 x 36 x 0,5	2	0,001	3,1	160,00
	S0662.3	GL		120 x 36 x 0,5	2	0,001	3,5	180,00
	S0663.3	BT		140 x 36 x 0,5	2	0,001	3,9	199,00
	S0664.3			160 x 36 x 0,5	2	0,001	4,4	218,00
	S0665.3			180 x 36 x 0,5	2	0,001	4,8	238,00
	S0666.3			200 x 36 x 0,5	2	0,002	5,2	257,00

## SMART ACCESSORI

PER MODELLI: DELUXE-TRILOGY-QUADRA-TAU. SPECIFICARE SEMPRE COLORE PROFILO (AL-BI)  
 FOR LINES: DELUXE-TRILOGY-QUADRA-TAU. ALWAYS SPECIFY PROFILE COLOUR (AL-BI)  
 POUR GAMMES: DELUXE-TRILOGY-QUADRA-TAU. SPECIFIER TOUJOURS LR COULEUR DU PROFIL (AL-BI)

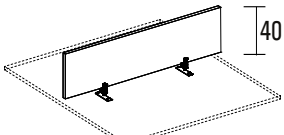
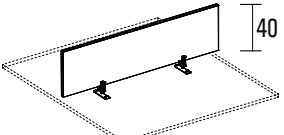
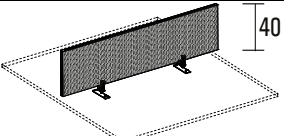
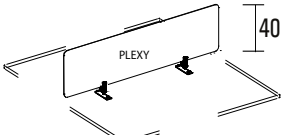
PANNELLI CENTRALI CENTRAL PANELS PANNEAUX CENTRALES	CODICE CODE CODE	FINITURA FINISHING FINISSAGE	FIN. STAFFA FIN. BRACKET FIN. SUPPORT	L x P x SP. W x D x TH. L x P x EP.	COLLI PACKS COLIS	VOLUMI VOLUME VOLUME	PESO WEIGHT POIDS	PREZZO
								PRICE PRIX €
 <p><b>Pannello centrale senza profilo con aggancio sotto al piano</b>  <i>Central panel without profile to be fixed under the top</i>                      Panneau centrale sans profil à fixer sous-plan</p>		NCA						
	S0660C	RM						
	S0661C	RSB		80 x 36 x 2,5	2	0,015	7,3	148,00
	S0662C	OL		100 x 36 x 2,5	2	0,019	8,6	153,00
	S0663C	GAV	AL	120 x 36 x 2,5	2	0,022	10,0	159,00
	S0664C	GTO	BI	140 x 36 x 2,5	2	0,026	11,4	165,00
	S0665C	BI	NR	160 x 36 x 2,5	2	0,029	12,7	170,00
	S0666C	RS		180 x 36 x 2,5	2	0,032	14,1	176,00
		AZ		200 x 36 x 2,5	2	0,036	15,5	182,00
	VR							
	GL							
 <p><b>Pannello centrale con profilo e aggancio sotto al piano</b>  <i>Central panel with profile to be fixed under the top</i>                      Panneau centrale avec profil à fixer sous-plan</p>		NCA						
	S0660.1C	RM						
	S0661.1C	RSB		80 x 36 x 2,5	2	0,015	7,3	182,00
	S0662.1C	OL		100 x 36 x 2,5	2	0,019	8,6	190,00
	S0663.1C	GAV	AL	120 x 36 x 2,5	2	0,022	10,0	198,00
	S0664.1C	GTO	BI	140 x 36 x 2,5	2	0,026	11,4	206,00
	S0665.1C	BI	NR	160 x 36 x 2,5	2	0,029	12,7	214,00
	S0666.1C	RS		180 x 36 x 2,5	2	0,032	14,1	222,00
		AZ		200 x 36 x 2,5	2	0,036	15,5	230,00
	VR							
	GL							
 <p><b>Pannello centrale rivestito in stoffa con profilo e aggancio sotto al piano</b>  <i>Central panel upholstered in fabric with profile to be fixed under the top</i>                      Panneau centrale en tissu avec profil à fixer sous-plan</p>								
	S0660.2C	GR (629)						
	S0661.2C	AV (532)		80 x 36 x 2,5	2	0,015	7,3	270,00
	S0662.2C	RS (236)		100 x 36 x 2,5	2	0,019	8,6	291,00
	S0663.2C	GL (53)	AL	120 x 36 x 2,5	2	0,022	10,0	312,00
	S0664.2C	VR (425)	BI	140 x 36 x 2,5	2	0,026	11,4	328,00
	S0665.2C	BL (386)	NR	160 x 36 x 2,5	2	0,029	12,7	349,00
	S0666.2C			180 x 36 x 2,5	2	0,032	14,1	370,00
				200 x 36 x 2,5	2	0,036	15,5	391,00
 <p><b>Pannello centrale in plexy con aggancio sotto al piano</b>  <i>Plexy frontal panel to be fixed under the top</i>                      Panneau centrale en plexy avec fixer sous-plan</p>								
	S0660.3C							
	S0661.3C	BI		80 x 36 x 0,5	2	0,002	3,5	203,00
	S0662.3C	RS	AL	100 x 36 x 0,5	2	0,002	4,0	222,00
	S0663.3C	GL	BI	120 x 36 x 0,5	2	0,002	4,4	241,00
	S0664.3C	BT	NR	140 x 36 x 0,5	2	0,002	4,8	261,00
	S0665.3C			160 x 36 x 0,5	2	0,003	5,3	280,00
	S0666.3C			180 x 36 x 0,5	2	0,003	5,7	300,00
				200 x 36 x 0,5	2	0,003	6,1	319,00

## SMART ACCESSORI

PER MODELLI: TRILOGY-QUADRA-TAU

FOR LINES: TRILOGY-QUADRA-TAU

POUR GAMMES: TRILOGY-QUADRA-TAU

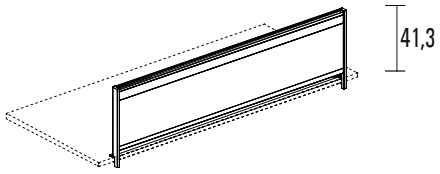
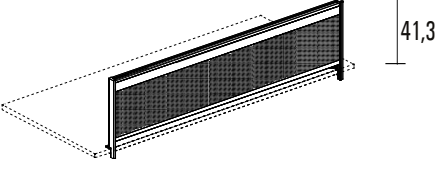
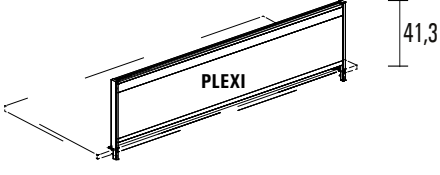
PANNELLI FRONTALI FRONTAL PANELS PANNEAUX FRONTALES	CODICE CODE CODE	FINITURA FINISHING FINISSAGE	FIN. TELAIO FIN. FRAME FIN. CHASSIS	L x P x SP. W x D x TH. L x P x EP.	COLLI PACKS COLIS	VOLUMI VOLUME VOLUME	PESO WEIGHT POIDS	PREZZO
								PRICE PRIX €
 <p><b>Pannello frontale legno con telaio attrezzabile, aggancio sotto al piano</b> <i>Wooden frontal panel with frame can be equipped to be fixed under the top</i> Panneau frontale mélaminé avec le châssis équipable à fixer sous-plan</p>		NCA RM						
	S0670	RSB	AL	80 x 41,3 x 3,5	1	0,029	7,6	325,00
	S0671	OL	BI	100 x 41,3 x 3,5	1	0,035	9,1	335,00
	S0662	GAV		120 x 41,3 x 3,5	1	0,041	10,6	349,00
	S0673	GTO	NR	140 x 41,3 x 3,5	1	0,048	12,1	364,00
	S0674	BI		160 x 41,3 x 3,5	1	0,054	13,6	377,00
	S0675	RS		180 x 41,3 x 3,5	1	0,061	15,2	392,00
	S0676	AZ	GA	200 x 41,3 x 3,5	1	0,067	16,8	407,00
		VR GL						
 <p><b>Pannello frontale rivestito con telaio attrezzabile, aggancio sotto al piano</b> <i>Wooden frontal panel upholstered in fabric with frame can be equipped to be fixed under the top</i> Panneau frontale en tissu avec le châssis équipable à fixer sous-plan</p>	S0670.2		AL	80 x 41,3 x 3,5	1	0,029	7,6	407,00
	S0671.2	GR (629)	BI	100 x 41,3 x 3,5	1	0,035	9,1	427,00
	S0672.2	AV (532)		120 x 41,3 x 3,5	1	0,041	10,6	453,00
	S0673.2	RS (236)	NR	140 x 41,3 x 3,5	1	0,048	12,1	476,00
	S0674.2	GL (53)		160 x 41,3 x 3,5	1	0,054	13,6	500,00
	S0675.2	VR (425)		180 x 41,3 x 3,5	1	0,061	15,2	526,00
	S0676.2	BL (386)	GA	200 x 41,3 x 3,5	1	0,067	16,8	564,00
 <p><b>Pannello frontale in plexi con telaio attrezzabile, aggancio sotto al piano</b> <i>Plexi frontal panel upholstered in fabric with frame can be equipped to be fixed under the top</i> Panneau frontale en plexi avec le châssis équipable à fixer sous-plan</p>	S0670.3		AL	80 x 41,3 x 3,5	1	0,029	4,4	377,00
	S0661.3		BI	100 x 41,3 x 3,5	1	0,035	5,1	401,00
	S0672.3	BI		120 x 41,3 x 3,5	1	0,041	5,8	429,00
	S0673.3	RS	NR	140 x 41,3 x 3,5	1	0,048	6,4	458,00
	S0674.3	GL		160 x 41,3 x 3,5	1	0,054	7,0	484,00
	S0675.3	BT		180 x 41,3 x 3,5	1	0,061	7,9	513,00
	S0676.3		GA	200 x 41,3 x 3,5	1	0,067	8,6	541,00

## SMART ACCESSORI

PER MODELLI: TRILOGY-QUADRA-TAU

FOR LINES: TRILOGY-QUADRA-TAU

POUR GAMMES: TRILOGY-QUADRA-TAU

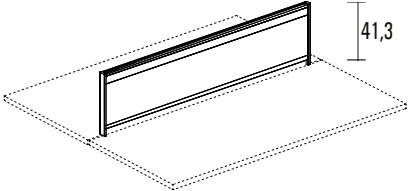
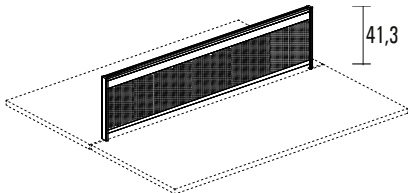
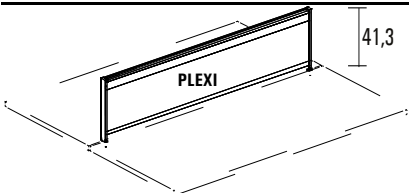
PANNELLI CENTRALI CENTRAL PANELS PANNEAUX CENTRALES	CODICE CODE CODE	FINITURA FINISHING FINISSAGE	FIN. TELAIO FIN. FRAME FIN. CHASSIS	L x P x SP. W x D x TH. L x P x EP.	COLLI PACKS COLIS	VOLUMI VOLUME VOLUME	PESO WEIGHT POIDS	PREZZO
								PRICE PRIX €
 <p><b>Pannello centrale legno con telaio attrezzabile, aggancio sotto al piano</b> <i>Wooden central panel with frame can be equipped to be fixed under the top</i> Panneau centrale mélaminé avec le châssis équipable à fixer sous-plan</p>		NCA RM						
	S0670C	RSB		80 x 41,3 x 3,5	1	0,030	8,1	335,00
	S0671C	OL		100 x 41,3 x 3,5	1	0,036	9,6	345,00
	S0672C	GAV		120 x 41,3 x 3,5	1	0,043	11,1	359,00
	S0673C	GTO	AL	140 x 41,3 x 3,5	1	0,049	12,6	374,00
	S0674C	BI	NR	160 x 41,3 x 3,5	1	0,056	14,1	387,00
	S0675C	RS	GA	180 x 41,3 x 3,5	1	0,062	15,7	402,00
	S0676C	AZ		200 x 41,3 x 3,5	1	0,069	17,3	417,00
 <p><b>Pannello centrale rivestito con telaio attrezzabile, aggancio sotto al piano</b> <i>Wooden central panel upholstered in fabric with frame can be equipped to be fixed under the top</i> Panneau centrale en tissu avec le châssis équipable à fixer sous-plan</p>	S0670.2C			80 x 41,3 x 3,5	1	0,030	8,1	410,00
	S0671.2C	GR (629)		100 x 41,3 x 3,5	1	0,036	9,6	431,00
	S0672.2C	AV (532)	AL	120 x 41,3 x 3,5	1	0,043	11,1	456,00
	S0673.2C	RS (236)	BI	140 x 41,3 x 3,5	1	0,049	12,6	480,00
	S0674.2C	GL (53)	NR	160 x 41,3 x 3,5	1	0,056	14,1	504,00
	S0675.2C	VR (425)	GA	180 x 41,3 x 3,5	1	0,062	15,7	529,00
	S0676.2C	BL (386)		200 x 41,3 x 3,5	1	0,069	17,3	568,00
	 <p><b>Pannello centrale in plexi con telaio attrezzabile, aggancio sotto al piano</b> <i>Plexi central panel upholstered in fabric with frame can be equipped to be fixed under the top</i> Panneau centrale en plexi avec le châssis équipable à fixer sous-plan</p>	S0670.3C			80 x 41,3 x 3,5	1	0,030	4,9
S0671.3C				100 x 41,3 x 3,5	1	0,036	5,6	411,00
S0672.3C		BI	AL	120 x 41,3 x 3,5	1	0,043	6,3	439,00
S0673.3C		RS	BI	140 x 41,3 x 3,5	1	0,049	6,9	468,00
S0674.3C		GL	NR	160 x 41,3 x 3,5	1	0,056	7,5	494,00
S0675.3C		BT	GA	180 x 41,3 x 3,5	1	0,062	8,4	523,00
S0676.3C				200 x 41,3 x 3,5	1	0,069	9,1	551,00

## SMART ACCESSORI

PER MODELLI: TRILOGY-QUADRA





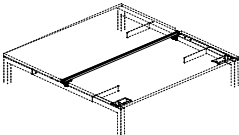
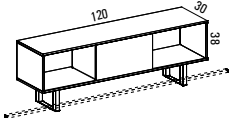
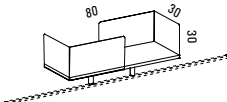
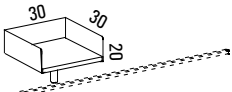
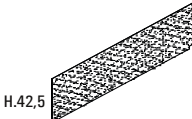

FOR LINES: TRILOGY-QUADRA

POUR GAMMES: TRILOGY-QUADRA

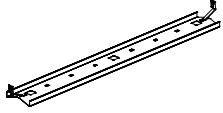
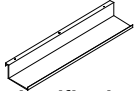
ACCESSORI PER SISTEMA BENCH ACCESSORIES FOR BENCH SYSTEM ACCESSOIRES POUR SYSTEME BENCH	CODICE CODE CODE	FINITURA FINISHING FINISSAGE	FIN. TELAIO FIN. FRAME FIN. CHASSIS	L x P x H. W x D x H. L x P x H	COLLI PACKS COLIS	VOLUMI VOLUME VOLUME	PESO WEIGHT POIDS	PREZZO PRICE PRIX €			
 <p><b>Barra porta accessori con aggancio sulle gambe</b> <i>Beam for accessories to be fixed on the double legs</i> <i>Barre pour accessoires à fixer sur le piétement double</i></p>	AC502	AL		120 x 2,5 x 2,5	1	0,003	2,3	102,00			
	AC503			140 x 2,5 x 2,5	1	0,004	2,6	103,00			
	AC504			160 x 2,5 x 2,5	1	0,004	3,0	110,00			
	AC505			180 x 2,5 x 2,5	1	0,005	3,2	115,00			
	AC506			200 x 2,5 x 2,5	1	0,005	3,6	117,00			
 <p><b>Porta documenti per barra porta accessori o sottopiano</b> <i>Case for documents to be hooked on accessory beam or under desktop</i> <i>Porte documents avec accrochement sur la barre accessoires ou sous-plan</i></p>	AC510	NCA RM RSB OL GAV GTO BI RS AZ VR GL	AL BI NR GA	120 x 30 x 38	1	0,160	22,0	199,00			
	 <p><b>Porta documenti con aggancio sulla barra porta accessori o sottopiano</b> <i>Case for documents to be hooked on accessory beam or under desktop</i> <i>Porte documents avec accrochement sur la barre accessoires ou sous-plan</i></p>	AC511	NCA RM RSB OL GAV GTO BI RS AZ VR GL	AL BI NR GA	80 x 30 x 30	1	0,090	8,0	179,00		
		 <p><b>Porta documenti con aggancio sulla barra porta accessori o sottopiano</b> <i>Case for documents to be hooked on accessory beam or under desktop</i> <i>Porte documents avec accrochement sur la barre accessoires ou sous-plan</i></p>	AC512	NCA RM RSB OL GAV GTO BI RS AZ VR GL	AL BI NR GA	80 x 30 x 20	1	0,005	3,6	194,00	
			 <p><b>Pannello frontale in plexiglass con aggancio sulla barra porta accessori</b> <i>Plexi frontal panel to be hooked on accessory beam</i> <i>Panneau frontale en plexi avec accrochement sur la barre</i></p>	AC522	BI RS GL BT		120 x 42,5 x 0,8	1	0,016	3,1	214,00
				AC523			140 x 42,5 x 0,8	1	0,019	3,6	264,00
				AC524			160 x 42,5 x 0,8	1	0,022	4,1	344,00
AC525				180 x 42,5 x 0,8			1	0,024	4,6	348,00	
AC526	200 x 42,5 x 0,8			1			0,027	5,1	351,00		

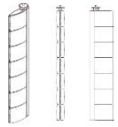
## SMART ACCESSORI

PER MODELLI: DIVO-DELUXE-TRILOGY-QUADRA-TAU  
 FOR LINES: DIVO-DELUXE-TRILOGY-QUADRA-TAU  
 POUR GAMMES: DIVO-DELUXE-TRILOGY-QUADRA-TAU





ACCESSORI ACCESSORIES ACCESSOIRES	CODICE CODE CODE	FINITURA FINISHING FINISSAGE	L x P x H. W x D x H. L x P x H	COLLI PACKS COLIS	VOLUMI VOLUME VOLUME	PESO WEIGHT POIDS	PREZZO PRICE PRIX		
							€		
 <p><b>Marsupio condiviso per elettrificazione da fissare alle gambe prof.125,5-165,2</b>  <i>Cable management pocket for shared desks to be fixed to legs depth cm 125,2 and cm 165,2</i>                      Goulotte pour postes partagés à fixer aux pieds prof. Cm 125,2 et cm 165,2</p>	AC602	AL	120 x 20 x 3,5	1	0,011	2,2	71,00		
	AC603	BI	140 x 20 x 3,5	1	0,013	3,1	77,00		
	AC604		160 x 20 x 3,5	1	0,015	3,6	79,00		
	AC605	NR	180 x 20 x 3,5	1	0,017	4,1	89,00		
	AC606		200 x 20 x 3,5	1	0,020	4,6	93,00		
	GA								
 <p><b>Marsupio per elettrificazione orizzontale da agganciare alla trave o fissare al piano</b>  <i>Cable management bag to hang on the beam for horizontal electrification</i>                      Poche passage cables pour électrification horizontale avec accrochement sur la poutre ou à fixer sous-plan</p>	AC610	AL	60 H.8 cm.	1	0,011	1,0	32,00		
	AC611	BI	120 H.8 cm.	1	0,019	2,0	46,00		
		NR							
		GA							
 <p><b>Marsupio per elettrificazione orizzontale da fissare sotto al piano</b>  <i>Cable management bag to hang under the desktop or fix on the top for horizontal electrification</i>                      Poche passage cables avec accrochement sous-plan pour électrification horizontale</p>	AC612	AL	60 H.8 cm.	1	0,029	2,2	46,00		
		BI							
		NR							
		GA							
 <p><b>Kit canalizzazione verticale</b>  <i>Vertical cable passage kit</i>                      Chemin de câbles verticale</p>	AC620	AL	60 H.8 cm.	1	0,003	0,6	37,00		
		BI							
		NR							
		CR					78,00		
 <p><b>Canalina in pvc a tre sezioni</b>  <i>PVC duct with 3 sections</i>                      Rigole pour pvc 3 sections</p>	AC621	AL					8,00		
							(Metro lineare) (Linear metre) (Metre lineaire)		
 <p><b>Reggicavi per canalizzazione orizzontale</b>  <i>Cable pocket for horizontal management</i>                      Porte câbles pour cablage horizontale</p>	AC625	AL				1	0,000	0,1	3,00
 <p><b>Marsupio per elettrificazione orizzontale da fissare sotto al piano</b>  <i>Cable management bag to hang under the desktop or fix on the top for horizontal electrification</i>                      Poche passage cables avec accrochement sous-plan pour électrification horizontale</p>	AC630	AL	50 x 10 x 5	1	0,003	1,0	31,00		
	AC631	BI	108 x 10 x 5	1	0,006	2,0	66,00		
	AC632		128 x 10 x 5	1	0,007	2,2	73,00		
	AC633	NR	148 x 10 x 5	1	0,008	2,4	78,00		
	AC634		168 x 10 x 5	1	0,013	2,6	86,00		
	GA								

## SMART ACCESSORI

PER MODELLI: DIVO-DELUXE-TRILOGY-QUADRA-TAU

FOR LINES: DIVO-DELUXE-TRILOGY-QUADRA-TAU

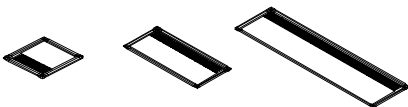
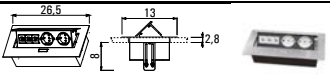
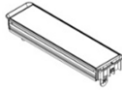
POUR GAMMES: DIVO-DELUXE-TRILOGY-QUADRA-TAU

ACCESSORI ACCESSORIES ACCESSOIRES	CODICE CODE CODE	FINITURA FINISHING FINISSAGE	L x P x H. W x D x H. L x P x H	COLLI PACKS COLIS	VOLUMI VOLUME VOLUME	PESO WEIGHT POIDS	PREZZO PRICE PRIX €
 ø 6 cm.  <b>Passacavo in plastica</b> <i>Plastic cable passage</i> Obturateur en plastique	AC700	AL	Diam.6 cm	0	0,000	0,0	10,00
  <b>Passacavo quadrato in metallo</b> <i>Metal square cable passage</i> Obturateur carré métallique	AC701	BI NR AL CR	10 x 10	1	0,000	0,3	33,00
  <b>Passacavo in metallo</b> <i>Metal cable passage</i> Obturateur métallique	AC705		10 x 10	1	0,000	0,2	36,00
	AC706	AL	24 x 10	1	0,001	0,3	55,00
	AC707		45 x 10	1	0,001	0,5	76,00
  <b>Gruppo prese incasso,cavi da scollegare in fase di chiusura.(sistema automatico di apertura)</b> <i>In wall plug device with cables to be disconnected in closing phase(Automatic open system)</i> Groupe prises en retrait,avec câbles à débrancher pendant la fermeture.(Ouverture automatique)	AC710	AL		1	0,020	2,0	253,00
  <b>Passacavo in plastica</b> <i>Plastic cable passage</i> Obturateur en plastique	AC720	AL	42 x 11	1	0,006	0,6	87,00
		BI					92,00
		CR					125,00
  <b>Passacavo in plastica</b> <i>Plastic cable passage</i> Obturateur en plastique	AC721	AL	80 x 11	1	0,012	1,5	141,00
		BI					154,00
		CR					214,00







## SMART ACCESSORI

PER MODELLI: DIVO-DELUXE-TRILOGY-QUADRA-TAU

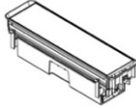
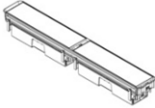
FOR LINES: DIVO-DELUXE-TRILOGY-QUADRA-TAU

POUR GAMMES: DIVO-DELUXE-TRILOGY-QUADRA-TAU





ACCESSORI ACCESSORIES ACCESSOIRES	CODICE CODE CODE	FINITURA FINISHING FINISSAGE	FINITURA COPERCHIO FIN. COVER FIN. COUVERTURE	L x P x H. W x D x H. L x P x H	COLLI PACKS COLIS	VOLUMI VOLUME VOLUME	PESO WEIGHT POIDS	PREZZO PRICE PRIX
								€
 <p><b>Passacavo in plastica con vaschetta</b> <i>Plastic cable passage with box</i> Obturbateur en plastique avec bol</p>	AC725	AL		42 x 11	1	0,006	0,8	108,00
		BI						114,00
		CR						146,00
 <p><b>Passacavo in plastica con vaschetta</b> <i>Plastic cable passage with box</i> Obturbateur en plastique avec bol</p>	AC726	AL		80 x 11	1	0,012	1,9	181,00
		BI						195,00
		CR						254,00
 <p><b>Passacavo in plastica</b> <i>Plastic cable passage</i> Obturbateur en plastique</p>	AC730	AL		42 x 11	1	0,006	0,2	36,00
		BI						22,00
		CR						51,00
 <p><b>Passacavo in plastica con vaschetta</b> <i>Plastic cable passage with box</i> Obturbateur en plastique avec bol</p>	AC731	AL		80 x 11	1	0,006	1,0	63,00
		BI						51,00
		CR						80,00
 <p><b>Passacavo in plastica con coperchio personalizzabile</b> <i>Plastic cable passage with customizable cover</i> Obturbateur en plastique avec couverture personnalisée</p>	AC730.1	AL	NCA RM RSB OL	42 x 11	1	0,006	0,2	52,00
		BI	GAV GTO BI					38,00
		CR	RS AZ VR GL					67,00
 <p><b>Passacavo in plastica con coperchio personalizzabile e vaschetta</b> <i>Plastic cable passage with customizable cover and box</i> Obturbateur en plastique avec couverture personnalisée et bol</p>	AC731.1	AL	NCA RM RSB OL	42 x 11	1	0,006	1,0	79,00
		BI	GAV GTO BI					67,00
		CR	RS AZ VR GL					96,00

## SMART ACCESSORI

PER MODELLI: DELUXE-TRILOGY-QUADRA-TAU

FOR LINES: DELUXE-TRILOGY-QUADRA-TAU

POUR GAMMES: DELUXE-TRILOGY-QUADRA-TAU





ACCESSORI PER BARRA-PROFILI-TELAIO ACCESSORIES FOR BEAM-PROFILE-FRAME ACCESSOIRES POUR BARRE-PROFIL-CHÂSSIS	CODICE CODE CODE	FINITURA FINISHING FINISSAGE	L x P x H. W x D x H. L x P x H	COLLI PACKS COLIS	VOLUMI VOLUME VOLUME	PESO WEIGHT POIDS	PREZZO PRICE PRIX
							€
 <p><b>Barra porta accessori con aggancio a paretine</b> <i>Accessory beam with hook on partitions</i> Barre porte accessoires avec accrochement sur cloisonnettes</p>	AC800	AL	L.80	1	0,004	1,0	96,00
	AC801		L.100	1	0,005	1,5	108,00
	AC802	BI	L.120	1	0,006	2,0	115,00
	AC803	NR	L.140	1	0,007	2,5	129,00
	AC804		L.160	1	0,008	3,0	140,00
	AC805		GA	L.180	1	0,009	3,5
 <p><b>Porta penna</b> <i>Pen holder</i> Porte stylos</p>	AC810	AL	14 x 11 x 8	1	0,001	0,5	41,00
BI							
NR							
GA							
 <p><b>Vaschetta porta documenti</b> <i>Document holder</i> Porte documents</p>	AC811	AL	37 x 28 x 8	1	0,008	1,0	50,00
BI							
NR							
GA							
 <p><b>Vaschetta porta documenti con ripiano</b> <i>Document holder with shelf</i> Porte documents avec rayons</p>	AC812	AL	37 x 28 x 12	1	0,012	1,5	85,00
BI							
NR							
GA							
 <p><b>Vaschetta porta docs</b> <i>Docs holder</i> Porte docs</p>	AC813	AL	20 x 25 x 22	1	0,011	2,0	60,00
BI							
NR							
GA							

## SMART ACCESSORI

PER MODELLI: DELUXE-TRILOGY-QUADRA-TAU

FOR LINES: DELUXE-TRILOGY-QUADRA-TAU

POUR GAMMES: DELUXE-TRILOGY-QUADRA-TAU

PORTA MONITOR E LAMPADE SCREEN HOLDER AND LAMPS PORTE MONITOR ET LAMPES	CODICE CODE CODE	FINITURA FINISHING FINISSAGE	L x P x H. W x D x H. L x P x H	COLLI PACKS COLIS	VOLUMI VOLUME VOLUME	PESO WEIGHT POIDS	PREZZO PRICE PRIX €
 <p><b>Braccio porta monitor con aggancio sul piano</b> <i>Screen holder with hook on desktop</i> Porte écran avec accrochement sur plan</p>	<b>AC850</b>	AL		2	0,010	3,5	<b>362,00</b>
		BI					
		NR					
		GA					
 <p><b>Braccio porta monitor con aggancio sulla barra porta accessori e sul telaio</b> <i>Screen holder with hook on accessory beam and frame</i> Porte écran avec accrochement sur barre porte accessoires et châssis</p>	<b>AC851</b>	AL		2	0,010	1,9	<b>270,00</b>
		BI					
		NR					
		GA					
 <p><b>Lampada LED</b> <i>Lamp</i> Lampe</p>	<b>AC852</b>	AL		1	0,016	3,0	<b>270,00</b>
 <p><b>Lampada LED con aggancio sulla barra porta accessori e sul telaio</b> <i>Lamp with hook on accessory beam and frame</i> Lampe avec accrochement sur barre porte accessoires et châssis</p>	<b>AC853</b>	AL		1	0,004	1,4	<b>288,00</b>
		BI					
		NR					
		GA					





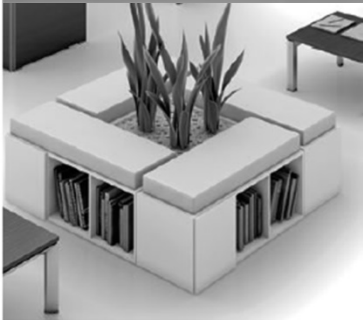

# STUDIO OFFICE







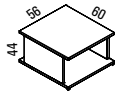
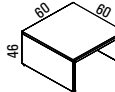
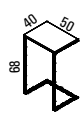

## SMART LOUNGE

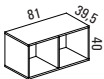
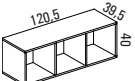
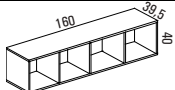

# SMART LOUNGE

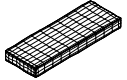
TAVOLI CAFFÈ COFFEE TABLES TABLES À CAFÉ	CODICE CODE CODE	FINITURA PIANI TOP FINISHING FIN. PLANS	FINITURA GAMBE LEG FINISHING FINITION PIEDS	L x P x H W x D x H L x P x H	COLLI PACKS COLIS	VOLUMI VOLUME VOLUME	PESO WEIGHT POIDS	PREZZO PRICE PRIX
								€
 <b>Tavolo caffè circolare piano legno diam.60</b> <i>Round coffee table with wooden top diameter 60</i> Table à café ronde avec plan mélaminé diamètre 60	S0783	NCA RM RSB OL GAV GTO BI	AL	Diam.60 H.52,5	3	0,044	21,3	320,00
			XL					435,00
 <b>Tavolo caffè circolare piano vetro diam.60</b> <i>Round coffee table with glass top diameter 60</i> Table à café ronde avec plan en verre diamètre 60	S0783V	VS VN VB VC VR	AL BI NR	Diam.60 H.51,2	3	0,053	24,5	592,00
			XL					707,00
			AL BI NR					660,00
			XL					775,00
 <b>Tavolo caffè 60x60 piano legno</b> <i>Coffee table 60x60 with wooden top</i> Table à café 60x60 avec plan mélaminé	S0783.1	NCA RM RSB OL GAV GTO BI	AL	60 x 60 x 52,5	3	0,052	22,8	324,00
			XL					448,00
 <b>Tavolo caffè 60x60 piano vetro</b> <i>Coffee table 60x60 with glass top</i> Table à café 60x60 avec plan en verre	S0783.1V	VS VN VB VC VR	AL BI NR	60 x 60 x 51,2	3	0,061	26,0	596,00
			XL					721,00
			AL BI NR					663,00
			XL					788,00
 <b>Tavolo caffè</b> <i>Coffee table</i> Table à café	S0785	NCA RM RSB OL GAV GTO BI		56 x 60 x 44	1	0,026	16,3	80,00
 <b>Tavolo caffè</b> <i>Coffee table</i> Table à café	S0786	NCA RM RSB OL GAV GTO BI		56 x 60 x 46	1	0,021	12,4	61,00
 <b>Porta notebook</b> <i>Notebook holder</i> Porte notebook	S0788	NCA RM RSB OL GAV GTO BI	AL BI GA	50 x 40 x 68	1	0,148	7,0	181,00

# SMART LOUNGE

ELEMENTI MOBILE CUBICO CUBIC CABINET ITEMS ELEMENTS MEUBLE CUBIQUE	CODICE CODE CODE	FINITURA FINISHING FINITION	FIN. SCOCCA STRUCTURE FINISHING FIN. STRUCT.	L x P x H. W x D x H. L x P x H.	COLLI PACKS COLIS	VOLUMI VOLUME VOLUME	PESO WEIGHT POIDS	PREZZO PRICE PRIX €
 <p><b>Mobile cubico a giorno</b> Open shelf cubic cabinet <i>Meuble cubique à jour</i></p>	S0580		AL NR BI GAV	81 x 39,5 x 40	1	0,141	16,9	74,00
 <p><b>Mobile cubico a giorno</b> Open shelf cubic cabinet <i>Meuble cubique à jour</i></p>	S0581		AL NR BI GAV	120,5x39,5x40	1	0,210	23,9	105,00
 <p><b>Mobile cubico a giorno</b> Open shelf cubic cabinet <i>Meuble cubique à jour</i></p>	S0582		AL NR BI GAV	160 x 39,5 x 40	1	0,279	30,9	136,00
 <p><b>Anta legno singola</b> Single wooden door for cubic cabinet <i>Porte single mélaminée pour meuble cubique</i></p>	S0583	NCA RM RSB OL GAV GTO BI		40 x 40 x SP.1,8	1	0,014	2,5	18,00
 <p><b>Anta vetro singola con telaio alluminio</b> Single glass door with aluminium frame <i>Porte single en verre avec chassis en aluminium</i></p>	S0584	VT		40 x 40 x SP.2	1	0,014	2,5	80,00
		VS						93,00
 <p><b>Anta vetro singola con telaio verniciato nero</b> Single glass door with black frame <i>Porte single en verre avec chassis noir</i></p>	S0584.1	VT		40 x 40 x SP.2	1	0,014	2,5	96,00
		VS						109,00
 <p><b>Cuscino 2 posti</b> 2 seat cushion <i>Coussin à 2 places</i></p>	S0585	CAT.		80 x 39,5 x 5	0	0,016	1,5	166,00
		A						
		B C						
 <p><b>Cuscino 3 posti</b> 3 seat cushion <i>Coussin à 3 places</i></p>	S0586	CAT.		120 x 39,5 x 5	0	0,025	2,5	229,00
		A						
		B C						
 <p>H.2,8 cm.</p>	AC120	AL	<b>Kit 4 piedini per mobile cubico a terra (Art.S0580)</b> <i>Small feet for cubic cabinet (art. PLO580)</i> 4 petits pieds pour meuble cubique (art. PLO580)					10,00
 <p>H.2,8 cm.</p>	AC120.1	AL	<b>Kit 6 piedini per mobile cubico a terra (Art.S0581)</b> <i>Small feet for cubic cabinet (art. PLO581)</i> 6 petits pieds pour meuble cubique (art. PLO581)					15,00
 <p>H.2,8 cm.</p>	AC120.2	AL	<b>Kit 8 piedini per mobile cubico a terra (Art.S0582)</b> <i>Small feet for cubic cabinet (art. PLO582)</i> 8 petits pieds pour meuble cubique (art. PLO582)					20,00

# STUDIO OFFICE

## SMART CONFERENCE





# SMART CONFERENCE

SULL'ORDINE SPECIFICARE SEMPRE LA FINITURA 1-2-3

ALWAYS SPECIFY FINISHING 1-2-3

SPECIFIER TOUJOURS LA FINITION 1-2-3

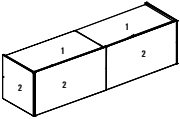
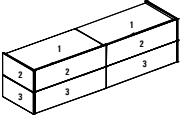
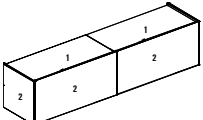
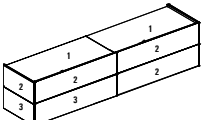
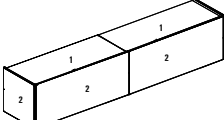
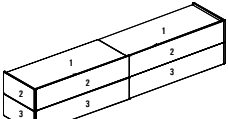
TAVOLI CONFERENZE CONFERENCE TABLES TABLES DE CONFERENCES	CODICE CODE CODE	FINITURA PIANI TOP FINISHING	FINITURA FRONTALI FIN. FRONTAL FIN. PANNEAU	L x P x H W x D x H L x P x H	COLLI PACKS COLIS	VOLUMI VOLUME VOLUME	PESO WEIGHT POIDS	PREZZO PRICE PRIX €
 <p><b>Tavolo conferenze L.285</b> <i>Conference table L.285</i> Table de conférence L.285</p>	<b>S0770</b>	NCA	NCA	285 x 82,5 x 72/74	6	0,336	150,0	<b>769,00</b>
		RM	RM					
		RSB	RSB					
		OL	OL					
		GAV	GAV					
		GTO	GTO					
	BI	BI						
 <p><b>Tavolo conferenze L.285</b> <i>Conference table L.285</i> Table de conférence L.285</p>	<b>S0771</b>	NCA	NCA	285 x 82,5 x 72/74	6	0,336	150,0	<b>809,00</b>
		RM	RM					
		RSB	RSB					
		OL	OL					
		GAV	GAV					
		GTO	GTO					
	BI	BI						
 <p><b>Tavolo conferenze L.325</b> <i>Conference table L.325</i> Table de conférence L.325</p>	<b>S0772</b>	NCA	NCA	325 x 82,5 x 72/74	6	0,386	170,0	<b>835,00</b>
		RM	RM					
		RSB	RSB					
		OL	OL					
		GAV	GAV					
		GTO	GTO					
	BI	BI						
 <p><b>Tavolo conferenze L.325</b> <i>Conference table L.325</i> Table de conférence L.325</p>	<b>S0773</b>	NCA	NCA	325 x 82,5 x 72/74	6	0,386	170,0	<b>877,00</b>
		RM	RM					
		RSB	RSB					
		OL	OL					
		GAV	GAV					
		GTO	GTO					
	BI	BI						
 <p><b>Tavolo conferenze L.365</b> <i>Conference table L.365</i> Table de conférence L.365</p>	<b>S0774</b>	NCA	NCA	365 x 82,5 x 72/74	6	0,436	188,0	<b>942,00</b>
		RM	RM					
		RSB	RSB					
		OL	OL					
		GAV	GAV					
		GTO	GTO					
	BI	BI						
 <p><b>Tavolo conferenze L.365</b> <i>Conference table L.365</i> Table de conférence L.365</p>	<b>S0775</b>	NCA	NCA	365 x 82,5 x 72/74	6	0,436	188,0	<b>1.005,00</b>
		RM	RM					
		RSB	RSB					
		OL	OL					
		GAV	GAV					
		GTO	GTO					
	BI	BI						

## SMART CONFERENCE

**SULL'ORDINE SPECIFICARE SEMPRE LA FINITURA 1-2**

*ALWAYS SPECIFY FINISHING 1-2*

**SPECIFIER TOUJOURS LA FINITION 1-2**

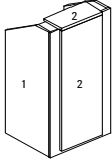
TAVOLI CONFERENZE CONFERENCE TABLES PUPITRE	CODICE CODE CODE	FINITURA PIANI TOP FINISHING FIN. PLANS	FINITURA FRONTALI FIN. FRONTAL FIN. PANNEAU	L x P x H W x D x H L x P x H	COLLI PACKS COLIS	VOLUMI VOLUME VOLUME	PESO WEIGHT POIDS	PREZZO PRICE PRIX
								€
 <p>Leggio Podium Pupitre</p>	<b>S0780</b>	<b>NCA</b>	<b>NCA</b>	60 x 72 x 122	1	0,082	40,0	<b>462,00</b>
		<b>RM</b>	<b>RM</b>					
		<b>RSB</b>	<b>RSB</b>					
		<b>OL</b>	<b>OL</b>					
		<b>GAV</b>	<b>GAV</b>					
		<b>GTO</b>	<b>GTO</b>					
		<b>BI</b>	<b>BI</b>					



**Sistema Integrus per la gestione traduzioni in simultanea**  
*Integrus System for simultaneous translation management.*  
Système Integrus pour la gestion des traductions simultanées



**Unità portatile CCS 900 Ultra per installazioni su tavolo**  
*Portable system CCS 900 Ultra for table-top installations.*  
Unité CCS 900 Ultra portable pour une installation sur une table



**Unità Concentus portatile per installazioni flessibili**  
*Portable Concentus units for (flexible) table-top placing*  
Unité Concentus portable pour une installation flexible sur une



**Unità DCN per installazioni portatili o fisse (incassate)**  
*Microphone units for portable or fixed (built-in) installations.*  
Unité de discussion pour les installations mobiles ou fixes (en-caissé)



**Unità ad incasso per strutture congressuali permanenti**  
*Flush mounted units for permanent conference facilities*  
Unité encaissée pour structures de conference fixes





**Prezzi da calcolare in base alla configurazione richiesta**  
*Prices must be calculated according to the request*  
Prix à calculer selon la configuration demandée

# STUDIO OFFICE





## MOBILI E CONTENITORI

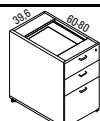
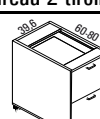
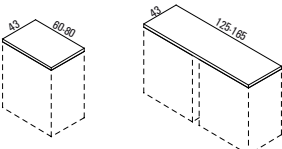

## MOBILI E CONTENITORI

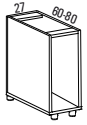
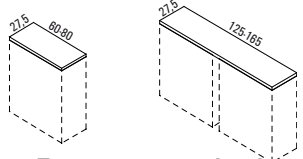
CASSETTIERE E CLASSIFICATORI DRAWER AND FILING CAISSONS	CODICE CODE CODE	FIN. TOP- FRONTALI TOP-FRONTAL FINISHING FIN. PLANS- TIROIRS	FIN. SCOCCA STRUCTURE FINISHING FIN. STRUCT.	L x P x H. W x D x H. L x P x H.	COLLI PACKS COLIS	VOLUMI VOLUME VOLUME	PESO WEIGHT POIDS	PREZZO PRICE PRIX €
			<b>S0200</b>	NCA RM RSB OL GAV GTO BI	AL NR BI GAV	39,6 x 55,5 x 57,3	1	0,135
<b>Cassettiera su ruote con serratura simultanea</b> <i>Mobile drawer pedestal on castors with lock</i> Caisson mobile 3 tiroirs avec serrure sur roulettes								
	<b>S0201</b>	NCA RM RSB OL GAV GTO BI	AL NR BI GAV	39,6 x 55,5 x 57,3	1	0,135	20,4	<b>198,00</b>
<b>Classificatore su ruote con serratura simultanea</b> <i>Mobile filing pedestal on castors with lock</i> Classeur mobile 1 tiroir+ 1 DS avec serrure sur roulette								
	<b>S0202</b>	NCA RM RSB OL GAV GTO BI	AL NR BI GAV	39,6 x 55,5 x 57,3	1	0,135	20,4	<b>206,00</b>
<b>Classificatore 5 ruote con serratura simultanea</b> <i>Mobile filing pedestal on 5 castors with lock</i> Classeur mobile 1 tiroir+ 1 DS avec serrure sur 5 roulettes								
	<b>S0203</b>	NCA RM RSB OL GAV GTO BI	AL NR BI GAV	39,6 x 60 x 69,5	1	0,176	22,0	<b>253,00</b>
<b>Cassettiera portante 4 cassetti con serratura simultanea</b> <i>Load bearing 4 drawer pedestal with lock</i> Caisson hauteur bureau 4 tiroirs avec serrure	<b>S0203.1</b>			39,6 x 80 x 69,5	1	0,234	26,8	<b>279,00</b>
	<b>S0204</b>	NCA RM RSB OL GAV GTO BI	AL NR BI GAV	39,6 x 60 x 69,5	1	0,176	22,0	<b>253,00</b>
<b>Classificatore portante 2 cass.+class. con serratura simultanea</b> <i>1 filing+ 2 drawer pedestal load bearing with lock</i> Caisson hauteur bureau 2 tiroirs+ 1 DS avec serrure	<b>S0204.1</b>			39,6 x 80 x 69,5	1	0,234	26,8	<b>279,00</b>
	<b>S0205</b>	NCA RM RSB OL GAV GTO BI	AL NR BI GAV	39,6 x 60 x 69,5	1	0,176	22,0	<b>253,00</b>
<b>Classificatore portante 2 cass.+class. con serratura simultanea</b> <i>1 filing+ 2 drawer pedestal load bearing with lock</i> Caisson hauteur bureau 2 DS avec serrure	<b>S0205.1</b>			39,6 x 80 x 69,5	1	0,234	26,8	<b>279,00</b>
	<b>S0210</b>	NCA		43 x 60 x SP.2,5	1	0,013	4,1	<b>29,00</b>
<b>Top cassettiere portanti</b> <i>Top for load bearing drawer pedestal</i> Top supérieure de caissons hauteur bureau	<b>S0211</b>	RM		43 x 80 x SP.2,5	1	0,017	5,3	<b>36,00</b>
	<b>S0212</b>	RSB		43 x 125,2 x SP.2,5	1	0,026	8,5	<b>60,00</b>
	<b>S0213</b>	OL		43 x 165,2 x SP.2,5	1	0,034	10,9	<b>74,00</b>
	<b>S0213</b>	GAV	GTO BI					

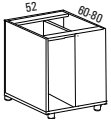
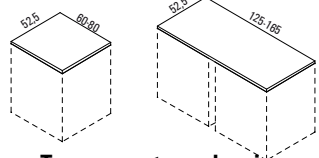

## MOBILI E CONTENITORI

CASSETTIERE E CLASSIFICATORI DRAWER AND FILING CAISSONS - CLASSEURS	CODICE CODE CODE	FINITURA FINISHING FINISSAGE	L x P x H. x D x H. x H.	W L x P	COLLI PACKS COLIS	VOLUMI VOLUME VOLUME	PESO WEIGHT POIDS	PREZZO PRICE PRIX
								€
 <p><b>Porta pc portante</b> <i>Load bearing cpu holder</i> Porte cpu porteur</p>	<b>S0207</b>	<b>AL NR BI GAV</b>	27 x 60 x 69,5		1	0,124	13,4	<b>78,00</b>
	<b>S0207.1</b>		27 x 80 x 69,5		1	0,164	18,0	<b>98,00</b>
 <p><b>Top per porta pc singolo</b> <i>Top for single cpu holder</i> Top supérieure pour porte cpu single</p>	<b>S0215</b>	<b>NCA RM RSB OL GAV GTO BI</b>	27,5 x 60 x SP.2,5		1	0,008	3,0	<b>23,00</b>
	<b>S0216</b>		27,5 x 80 x SP.2,5		1	0,011	3,9	<b>28,00</b>
	<b>S0217</b>		27,5 x 125,2 x SP.2,5		1	0,017	5,8	<b>39,00</b>
	<b>S0218</b>		27,5 x 165,2 x SP.2,5		1	0,022	7,4	<b>48,00</b>
 <p><b>Porta doppio pc portante</b> <i>Double load-bearing cpu holder</i> Porte cpu double porteur</p>	<b>S0208</b>	<b>AL NR BI GAV</b>	52 x 60 x 69,5		1	0,231	21,1	<b>115,00</b>
	<b>S0208.1</b>		52 x 80 x 69,5		1	0,306	28,3	<b>147,00</b>
 <p><b>Porta doppio pc portante BIFACCIALE</b> <i>Double load-bearing cpu holder DOUBLE FACE</i> Porte cpu double porteur DOUBLE FACE</p>	<b>S0209</b>	<b>AL NR BI GAV</b>	52 x 60 x 69,5		1	0,231	21,1	<b>115,00</b>
	<b>S0209.1</b>		52 x 80 x 69,5		1	0,306	28,3	<b>147,00</b>
 <p><b>Top per porta pc doppio</b> <i>Top for double cpu holder</i> Top supérieure pour porte cpu double porteur</p>	<b>S0210.1</b>	<b>NCA RM RSB OL GAV GTO BI</b>	52,5 x 60 x SP.2,5		1	0,015	4,4	<b>25,00</b>
	<b>S0211.1</b>		52,5 x 80 x SP.2,5		1	0,020	5,9	<b>34,00</b>
	<b>S0212.1</b>		52,5 x 125,2 x SP.2,5		1	0,031	9,2	<b>52,00</b>
	<b>S0213.1</b>				1	0,041	12,1	<b>69,00</b>
 <p><b>Chiusura soft per cassetiera (Kit x 3 cassetti)</b> <i>Soft close mechanism (3 drawer kit)</i> Fermeture amortie (kit pour 3 tiroirs)</p>	<b>S0250</b>		PORTATA MAX CASSETTO 20 Kg <i>MAXIMUM WEIGHT X DRAWER 20 Kgs</i> CAPACITE MAXIMALE TIROIR 20 Kgs					<b>36,00</b>
 <p><b>Maniglia cromata per ante legno</b> <i>Handle chromed for wooden desk</i> Poignée chromé pour portes mélaminé</p>	<b>AC110</b>	<b>BI CR NR</b>						<b>6,00</b>
								PER DIFFERENZA <i>FOR DIFFERENCE</i> DE LA DIFFÉRENCE

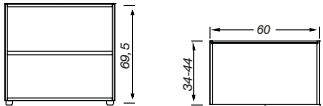
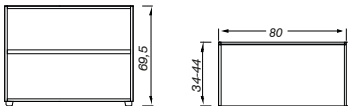
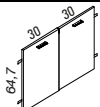
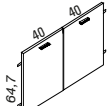
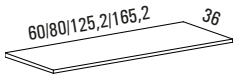
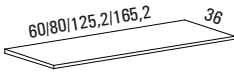
## MOBILI E CONTENITORI

MOBILI ESTENSIONE PIANO DESKTOP EXTENSION CABINETS MEUBLES EXTENSION PLAN	CODICE CODE CODE	FIN. TOP ANTE TOP-DOORS FINISHING FIN. PLANS-PORTES	FIN. SCOCCA STRUCTURE FINISHING FIN. STRUCT.	L x P x H. W x D x H. L x P x H.	COLLI PACKS COLIS	VOLUMI VOLUME VOLUME	PESO WEIGHT POIDS	PREZZO PRICE PRIX €
 <p><b>Mobile estensione piano L.60</b> <i>Desktop extension cabinet W.60</i> Meuble rallonge plan L.60</p>	<b>S0220</b>		<b>AL NR BI GAV</b>	60 x 34 x 69,5	1	0,050	20,8	<b>92,00</b>
	<b>S0220.1</b>			60 x 44 x 69,5	1	0,057	25,1	<b>110,00</b>
 <p><b>Mobile estensione piano L.80</b> <i>Desktop extension cabinet W.80</i> Meuble rallonge plan L.80</p>	<b>S0221</b>		<b>AL NR BI GAV</b>	80 x 34 x 69,5	1	0,061	25,6	<b>111,00</b>
	<b>S0221.1</b>			80 x 44 x 69,5	1	0,068	30,8	<b>133,00</b>
 <p><b>Coppia ante basse per contenitore L.60</b> <i>Pair of low doors for cabinets W.60</i> Jeu de portes basses pour armoire L.60</p>	<b>S0225</b>	<b>NCA RM RSB OL GAV GTO BI</b>		2 x L.30 H.64,7 SP.1,8	1	0,010	5,4	<b>66,00</b>
 <p><b>Coppia ante basse per contenitore L.80</b> <i>Pair of low doors for cabinets W.80</i> Jeu de portes basses pour armoire L.80</p>	<b>S0226</b>	<b>NCA RM RSB OL GAV GTO BI</b>		2 x L.40 H.64,7 SP.1,8	1	0,013	7,2	<b>73,00</b>
 <p><b>Top per contenitori Prof.34</b> <i>Top for cabinets Depth.34</i> Top pour armoires Prof. 34</p>	<b>S0230</b>	<b>NCA RM RSB OL GAV GTO BI</b>		60 x 36 x SP.2,5	1	0,011	4,1	<b>18,00</b>
	<b>S0231</b>			80 x 36 x SP.2,5	1	0,014	5,5	<b>23,00</b>
	<b>S0232</b>			125,2 x 36 x SP.2,5	1	0,022	8,6	<b>36,00</b>
	<b>S0233</b>			165,2 x 36 x SP.2,5	1	0,029	11,3	<b>47,00</b>
 <p><b>Top per contenitori Prof.34</b> <i>Top for cabinets Depth.34</i> Top pour armoires Prof. 34</p>	<b>S0230.1</b>	<b>NCA RM RSB OL GAV GTO BI</b>		60 x 36 x SP.2,5	1	0,013	5,2	<b>22,00</b>
	<b>S0231.1</b>			80 x 36 x SP.2,5	1	0,018	7,0	<b>30,00</b>
	<b>S0232.1</b>			125,2 x 36 x SP.2,5	1	0,027	10,9	<b>46,00</b>
	<b>S0233.1</b>			165,2 x 36 x SP.2,5	1	0,036	14,4	<b>60,00</b>

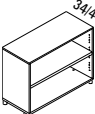
**MOBILI E CONTENITORI**

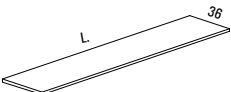
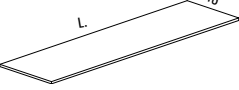
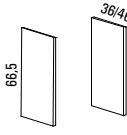
<b>MOBILI ESTENSIONE PIANO</b> <b>DESKTOP EXTENSION CABINETS</b> <b>ARMOIRES EXTENSION PLAN</b>	<b>CODICE</b> <b>CODE</b> <b>CODE</b>	<small>FIN. TOP ANTE</small> <small>TOP DOORS FINISHING</small> <small>FIN. PLANS-PORTES</small>	<small>FIN. SCOCCA</small> <small>STRUCTURE</small> <small>FINISHING</small> <small>FIN. STRUCT.</small>	<b>L x P x H.</b> <b>W x D x H.</b> <b>L x P x H.</b>	<b>COLLI</b> <b>PACKS</b> <b>COLIS</b>	<b>VOLUMI</b> <b>VOLUME</b> <b>VOLUME</b>	<b>PESO</b> <b>WEIGHT</b> <b>POIDS</b>	<b>PREZZO</b> <b>PRICE</b> <b>PRIX</b>
								<b>€</b>
 <b>H.69,5</b> <b>Contenitore basso a giorno L.45</b> <i>Low cabinet L.45</i> Armoire basse à jour L.45	<b>SO100</b>		<b>AL</b> <b>NR</b> <b>BI</b> <b>GAV</b>	45 x 34 x 69,5	1	0,036	13,0	<b>70,00</b>
	<b>SO100.1</b>			45 x 44 x 69,5	1	0,039	16,8	<b>86,00</b>
 <b>H.69,5</b> <b>Contenitore basso a giorno L.90</b> <i>Low cabinet L.90</i> Armoire basse à jour L.90	<b>SO101</b>		<b>AL</b> <b>NR</b> <b>BI</b> <b>GAV</b>	90 x 34 x 69,5	1	0,061	19,4	<b>107,00</b>
	<b>SO101.1</b>			90 x 44 x 69,5	1	0,068	25,1	<b>130,00</b>
 <b>SX</b> <b>Anta basse singola per contenitore H.69,5</b> <i>Low door for cabinets H.69,5</i> Porte basse pour armoire H.69,5	<b>SO120</b> <b>DX-SX</b>	<b>NCA</b> <b>RM</b> <b>RSB</b> <b>OL</b> <b>GAV</b> <b>GTO</b> <b>BI</b>		45 H.64,7 SP.1,8	1	0,014	4,1	<b>39,00</b>
 <b>Coppia ante basse per contenitore L.80</b> <i>Pair of low doors for cabinets W.80</i> Jeu de portes basses pour armoire L.80	<b>SO120.2</b>	<b>NCA</b> <b>RM</b> <b>RSB</b> <b>OL</b> <b>GAV</b> <b>GTO</b> <b>BI</b>		2 x 45 H.64,7 SP.1,8	1	0,014	8,2	<b>77,00</b>
 <b>Top per contenitori Prof.34</b> <i>Top for cabinets Depth.34</i> Top pour armoires Prof. 34	<b>SO140.2</b>	<b>NCA</b>		45x36xSP.2,5 (1 anta-door-porte)	1	0,008	3,1	<b>13,00</b>
	<b>SO141.2</b>	<b>RM</b>		90x36xSP.2,5 (2 ante-doors-portes)	1	0,016	6,2	<b>26,00</b>
	<b>SO142.2</b>	<b>RSB</b>		135x36xSP.2,5 (3 ante-doors-portes)	1	0,023	9,2	<b>39,00</b>
	<b>SO143.2</b>	<b>OL</b>		180x36xSP.2,5 (4 ante-doors-portes)	1	0,031	12,3	<b>52,00</b>
	<b>SO144.2</b>	<b>GAV</b>		225x36xSP.2,5 (5 ante-doors-portes)	1	0,039	15,4	<b>64,00</b>
	<b>SO145.2</b>	<b>GTO</b> <b>BI</b>		270x36xSP.2,5 (6 ante-doors-portes)	1	0,047	18,5	<b>77,00</b>
 <b>Top per contenitori Prof.44</b> <i>Top for cabinets Depth.44</i> Top pour armoires Prof. 44	<b>SO140.3</b>	<b>NCA</b>		45x46xSP.2,5 (1 anta-door-porte)	1	0,010	3,9	<b>17,00</b>
	<b>SO141.3</b>	<b>RM</b>		90x46xSP.2,5 (2 ante-doors-portes)	1	0,020	7,9	<b>33,00</b>
	<b>SO142.3</b>	<b>RSB</b>		135x46xSP.2,5 (3 ante-doors-portes)	1	0,030	11,8	<b>50,00</b>
	<b>SO143.3</b>	<b>OL</b>		180x46xSP.2,5 (4 ante-doors-portes)	1	0,039	15,7	<b>66,00</b>
	<b>SO144.3</b>	<b>GAV</b>		225x46xSP.2,5 (5 ante-doors-portes)	1	0,049	19,7	<b>82,00</b>
	<b>SO145.3</b>	<b>GTO</b> <b>BI</b>		270x46xSP.2,5 (6 ante-doors-portes)	1	0,059	23,6	<b>99,00</b>
 <b>Coppia fianchi finali bassi per contenitori H.69,5</b> <i>2 low side panels for cabinets H.69,5</i> Jeu de côtés de FINITIONbasses pour armoires H.69,5	<b>SO170</b>	<b>NCA</b> <b>RM</b> <b>RSB</b> <b>OL</b> <b>GAV</b> <b>GTO</b> <b>BI</b>		36 x H.66,5 SP.1,8	1	0,020	6,8	<b>30,00</b>
	<b>SO170.1</b>			46 x H.66,5 SP.1,8	1	0,026	8,7	<b>39,00</b>

## MOBILI E CONTENITORI

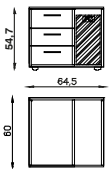
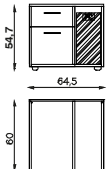
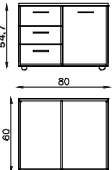
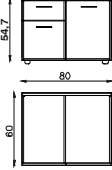
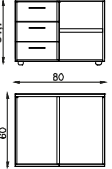
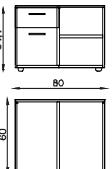
MOBILI DI SERVIZIO PORTANTI H.54,7 LOAD BEARING CABINETS H.54,7 MEUBLES DE RANGEMENT PORTEURS H.54,7	CODICE CODE CODE	FIN. TOP FRONT- SCHEN. TOP. FRONTAL FINISHING FIN. PLANS-TIROIRS	FIN. SCOCCA STRUCTURE FINISHING FIN. STRUCT.	L x P x H. W x D x H. L x P x H.	COLLI PACKS COLIS	VOLUMI VOLUME VOLUME	PESO WEIGHT POIDS	PREZZO PRICE PRIX €
 <p>SX</p> <p>Mobile di servizio portante N°3 cass.+porta pc Load bearing service cabinet N°3 drawers+cpu case Meuble de service porteur avec N°3 tiroirs+porte cpu</p>	S0400 DX-SX	NCA RM RSB OL GAV GTO BI	AL NR BI GAV	64,5 x 60 x 54,7	1	0,223	30,0	318,00
 <p>SX</p> <p>Mobile di servizio portante con cass.+class.+porta pc Load bearing service cabinet with drawer+filing drawer cpu case Meuble de service porteur avec tiroir+classeur+porte cpu</p>	S0400.1 DX-SX	NCA RM RSB OL GAV GTO BI	AL NR BI GAV	64,5 x 60 x 54,7	1	0,223	30,0	318,00
 <p>SX</p> <p>Mobile di servizio portante N°3 cass.+anta Load bearing service cabinet N°3 drawers+door Meuble de service porteur avec N°3 tiroirs+porte</p>	S0401 DX-SX	NCA RM RSB OL GAV GTO BI	AL NR BI GAV	80 x 60 x 54,7	1	0,275	37,0	389,00
 <p>SX</p> <p>Mobile di servizio portante con cass.+class.+anta Load bearing service cabinet with drawer+filing drawer+door Meuble de service porteur avec tiroir+classeur+porte</p>	S0401.1 DX-SX	NCA RM RSB OL GAV GTO BI	AL NR BI GAV	80 x 60 x 54,7	1	0,275	37,0	389,00
 <p>SX</p> <p>Mobile di servizio portante N°3 cass.+vano a giorno Load bearing service cabinet N°3 drawers+open case Meuble de service porteur avec N°3 tiroirs+compt à jour</p>	S0402 DX-SX	NCA RM RSB OL GAV GTO BI	AL NR BI GAV	80 x 60 x 54,7	1	0,275	34,0	353,00
 <p>SX</p> <p>Mobile di servizio portante con cass.+class.+vano a giorno Load bearing service cabinet with drawer+filing drawer+open case Meuble de service porteur avec tiroir+classeur+compt à jour</p>	S0402.1 DX-SX	NCA RM RSB OL GAV GTO BI	AL NR BI GAV	80 x 60 x 54,7	1	0,275	34,0	353,00

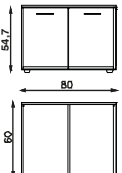
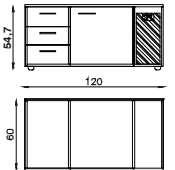
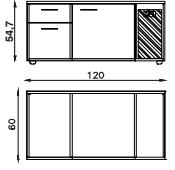
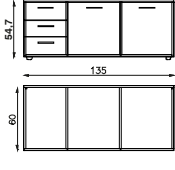
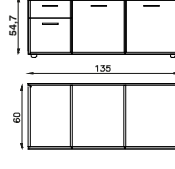
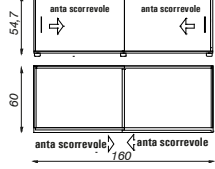

## MOBILI E CONTENITORI

<b>MOBILI DI SERVIZIO PORTANTI H.54,7</b> <b>LOAD BEARING CABINETS H.54,7</b> <b>MEUBLES DE RANGEMENT PORTEURS H.54,7</b>	<b>CODICE</b> <b>CODE</b> <b>CODE</b>	<small>FIN. TOP FRONT- SCHIEN. TOP FRONTAL FINISHING FIN. PLANS-TIROIRS</small>	<small>FIN. SCOCCA STRUCTURE FINISHING FIN. STRUCT.</small>	<b>L x P x H.</b> <b>W x D x H.</b> <b>L x P x H.</b>	<b>COLLI</b> <b>PACKS</b> <b>COLIS</b>	<b>VOLUMI</b> <b>VOLUME</b> <b>VOLUME</b>	<b>PESO</b> <b>WEIGHT</b> <b>POIDS</b>	<b>PREZZO</b> <b>PRICE</b> <b>PRIX</b>
								€
 <p><b>Mobile di servizio portante con 2 ante</b>  <i>Load bearing service cabinet with 2 doors</i>  <b>Meuble de service porteur avec 2 portes</b></p>	<b>S0403</b>	<b>NCA</b> <b>RM</b> <b>RSB</b> <b>OL</b> <b>GAV</b> <b>GTO</b> <b>BI</b>	<b>AL</b> <b>NR</b> <b>BI</b> <b>GAV</b>	80 x 60 x 54,7	1	0,275	32,0	<b>237,00</b>
 <p><b>Mobile di servizio portante N°3 cass.+anta+porta pc</b>  <i>Load bearing service cabinet N°3 drawers+door+cpu case</i>  <b>Meuble de service porteur avec N°3 tiroirs+porte+porte cpu</b></p>	<b>S0404</b> <b>DX-SX</b>	<b>NCA</b> <b>RM</b> <b>RSB</b> <b>OL</b> <b>GAV</b> <b>GTO</b> <b>BI</b>	<b>AL</b> <b>NR</b> <b>BI</b> <b>GAV</b>	120 x 60 x 54,7	1	0,408	58,0	<b>557,00</b>
 <p><b>Mobile di servizio portante con cass.+class.+anta+porta pc</b>  <i>Load bearing service cabinet with drawer+filing drawer+door+cpu case</i>  <b>Meuble de service porteur avec tiroir+classeur+porte+porte cpu</b></p>	<b>S0404.1</b> <b>DX-SX</b>	<b>NCA</b> <b>RM</b> <b>RSB</b> <b>OL</b> <b>GAV</b> <b>GTO</b> <b>BI</b>	<b>AL</b> <b>NR</b> <b>BI</b> <b>GAV</b>	120 x 60 x 54,7	1	0,408	58,0	<b>557,00</b>
 <p><b>Mobile di servizio portante con cass.+2 ante</b>  <i>Load bearing service cabinet with 3 drawer+2 doors</i>  <b>Meuble de service porteur avec 3 tiroirs+2 portes</b></p>	<b>S0405</b> <b>DX-SX</b>	<b>NCA</b> <b>RM</b> <b>RSB</b> <b>OL</b> <b>GAV</b> <b>GTO</b> <b>BI</b>	<b>AL</b> <b>NR</b> <b>BI</b> <b>GAV</b>	135 x 60 x 54,7	1	0,459	64,0	<b>621,00</b>
 <p><b>Mobile di servizio portante con cass.+class.+2 ante</b>  <i>Load bearing service cabinet with drawer+filing drawer+2 doors</i>  <b>Meuble de service porteur avec tiroir+classeur+2 portes</b></p>	<b>S0405.1</b> <b>DX-SX</b>	<b>NCA</b> <b>RM</b> <b>RSB</b> <b>OL</b> <b>GAV</b> <b>GTO</b> <b>BI</b>	<b>AL</b> <b>NR</b> <b>BI</b> <b>GAV</b>	135 x 60 x 54,7	1	0,459	64,0	<b>621,00</b>
 <p><b>Mobile di servizio portante MONOFACCIALE 2 ante scorrevoli</b>  <i>Load bearing service cabinet with 2 sliding doors</i>  <b>Meuble de service porteur avec 2 portes coulissantes</b></p>	<b>S0406</b>	<b>NCA</b> <b>RM</b> <b>RSB</b> <b>OL</b> <b>GAV</b> <b>GTO</b> <b>BI</b>	<b>AL</b> <b>NR</b> <b>BI</b> <b>GAV</b>	160 x 60 x 54,7	1	0,542	75,0	<b>464,00</b>

## MOBILI E CONTENITORI

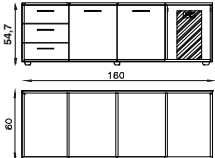
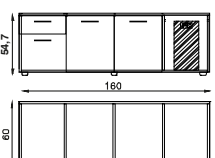
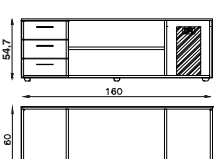
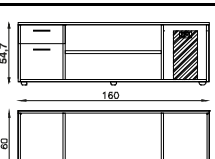
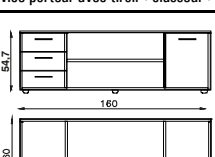
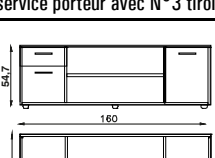
MOBILI DI SERVIZIO PORTANTI H.54,7 LOAD BEARING CABINETS H.54,7 MEUBLES DE RANGEMENT PORTEURS H.54,7	CODICE CODE CODE	FIN. TOP FRONT- SCHEN. TOP- FRONTAL FINISHING FIN. PLANS-TIROIRS	FIN. SCOCCA STRUCTURE FINISHING FIN. STRUCT.	L x P x H. W x D x H. L x P x H.	COLLI PACKS COLIS	VOLUMI VOLUME VOLUME	PESO WEIGHT POIDS	PREZZO PRICE PRIX €
 <p><b>Mobile di servizio portante N°3 cass.+porta pc+2 ante</b> <i>Load bearing service cabinet N°3 drawers+cpu case+2 doors</i> <i>Meuble de service porteur avec N°3 tiroirs+porte cpu+2 portes</i></p>	<b>S0410 DX-SX</b>	NCA RM RSB OL GAV GTO BI	AL NR BI GAV	160 x 60 x 54,7	1	0,542	75,0	<b>732,00</b>
 <p><b>Mobile di servizio portante con cass.+class.+porta pc+2 ante</b> <i>Load bearing service cabinet with drawer+filing drawer+cpu case+2 doors</i> <i>Meuble de service porteur avec tiroir+classeur+porte cpu+2 portes</i></p>	<b>S0410.1 DX-SX</b>	NCA RM RSB OL GAV GTO BI	AL NR BI GAV	160 x 60 x 54,7	1	0,542	75,0	<b>732,00</b>
 <p><b>Mobile di servizio portante N°3 cass.+porta pc+vano a giorno</b> <i>Load bearing service cabinet N°3 drawers+cpu case+open case</i> <i>Meuble de service porteur avec N°3 tiroirs+porte cpu+compt. à jour</i></p>	<b>S0411 DX-SX</b>	NCA RM RSB OL GAV GTO BI	AL NR BI GAV	160 x 60 x 54,7	1	0,542	68,0	<b>657,00</b>
 <p><b>Mobile di servizio portante con cass.+class.+porta pc+zona giorno</b> <i>Load bearing service cabinet with drawer+filing drawer+cpu case+open case</i> <i>Meuble de service porteur avec tiroir+classeur+porte cpu+compt. à jour</i></p>	<b>S0411.1 DX-SX</b>	NCA RM RSB OL GAV GTO BI	AL NR BI GAV	160 x 60 x 54,7	1	0,542	68,0	<b>657,00</b>
 <p><b>Mobile di servizio portante N°3 cass.+porta pc+anta</b> <i>Load bearing service cabinet N°3 drawers+cpu case+door</i> <i>Meuble de service porteur avec N°3 tiroirs+porte cpu+porte</i></p>	<b>S0412 DX-SX</b>	NCA RM RSB OL GAV GTO BI	AL NR BI GAV	160 x 60 x 54,7	1	0,542	71,0	<b>693,00</b>
 <p><b>Mobile di servizio portante con cass.+class.+porta pc+anta</b> <i>Load bearing service cabinet with drawer+filing drawer+cpu case+door</i> <i>Meuble de service porteur avec tiroir+classeur+porte cpu+porte</i></p>	<b>S0412.1 DX-SX</b>	NCA RM RSB OL GAV GTO BI	AL NR BI GAV	160 x 60 x 54,7	1	0,542	71,0	<b>693,00</b>

## MOBILI E CONTENITORI

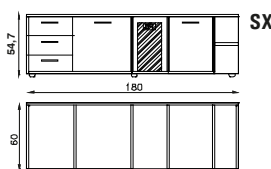
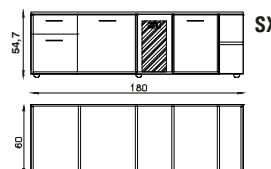
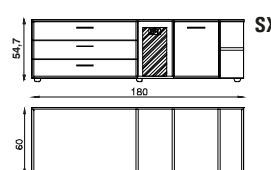
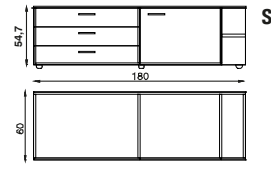
MOBILI DI SERVIZIO PORTANTI H.54,7 LOAD BEARING CABINETS H.54,7 MEUBLES DE RANGEMENT PORTEURS H.54,7	CODICE CODE CODE	FIN. TOP FRONT. SCHEN. TOP. FRONTAL-BACK PANEL FIN. PLANS-TIROIRS	FIN. SCOCCA STRUCTURE FINISHING FIN. STRUCT.	L x P x H. W x D x H. L x P x H.	COLLI PACKS COLIS	VOLUMI VOLUME VOLUME	PESO WEIGHT POIDS	PREZZO PRICE PRIX €
 <p><b>Mobile di servizio portante N°3 cass.+ porta pc+2 ante+zona a giorno</b> Load bearing service cabinet N°3 drawers+cpu case+2 doors+open case Meuble de service porteur avec N°3 tiroirs+porte cpu+2 portes+compt. à jour</p>	<b>S0414 DX-SX</b>	NCA RM RSB OL GAV GTO BI	AL NR BI GAV	180 x 60 x 54,7	1	0,609	85,0	<b>837,00</b>
 <p><b>Mobile di servizio portante con cass.+ class.+porta pc+2 ante+zona a giorno frontale</b> Load bearing service cabinet with drawer+filing drawer+cpu case+2 doors Meuble de service porteur avec tiroir + classeur+ porte cpu+2 portes</p>	<b>S0414.1 DX-SX</b>	NCA RM RSB OL GAV GTO BI	AL NR BI GAV	180 x 60 x 54,7	1	0,609	85,0	<b>837,00</b>
 <p><b>Mobile di servizio portante N°3 cassettoni +porta pc+anta+zona a giorno frontale</b> Load bearing service cabinet N°3 drawers+cpu case+door+open case Meuble de service porteur avec N°3 tiroirs+porte cpu+porte+compt. à jour</p>	<b>S0415 DX-SX</b>	NCA RM RSB OL GAV GTO BI	AL NR BI GAV	180 x 60 x 54,7	2	0,609	88,0	<b>817,00</b>
 <p><b>Mobile di servizio portante N°3 cassettoni +anta+zona a giorno frontale</b> Load bearing service cabinet N°3 drawers +door+open case Meuble de service porteur avec N°3 tiroirs+porte+compt. à jour</p>	<b>S0416 DX-SX</b>	NCA RM RSB OL GAV GTO BI	AL NR BI GAV	180 x 60 x 54,7	2	0,609	90,0	<b>826,00</b>

**MOBILI E CONTENITORI**

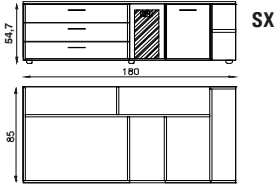
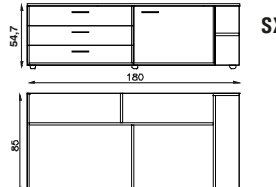
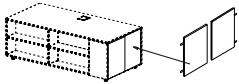
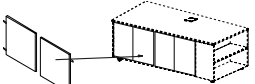
<b>MOBILI DI SERVIZIO PORTANTI H.54,7</b> <b>LOAD BEARING CABINETS H.54,7</b> <b>MEUBLES DE RANGEMENT PORTEURS H.54,7</b>	<b>CODICE</b> <b>CODE</b> <b>CODE</b>	<small>FIN. TOP FRONT.: SCHIEN. TOP: FRONTAL FINISHING FIN. PLANS-TIROIRS</small>	<small>FIN. SCOCCA STRUCTURE FINISHING FIN. STRUCT.</small>	<b>L x P x H.</b> <b>W x D x H.</b> <b>L x P x H.</b>	<b>COLLI</b> <b>PACKS</b> <b>COLIS</b>	<b>VOLUMI</b> <b>VOLUME</b> <b>VOLUME</b>	<b>PESO</b> <b>WEIGHT</b> <b>POIDS</b>	<b>PREZZO</b> <b>PRICE</b> <b>PRIX</b> <b>€</b>
 <p><b>Mobile di servizio portante N°3 cassettoni + porta pc+anta+zona a giorno frontale</b>  <i>Load bearing service cabinet N°3 drawers+cpu case+door+open case</i>  <b>Meuble de service porteur avec N°3 tiroirs+porte cpu+porte+compt. à jour</b></p>	<b>S0420</b> <b>DX-SX</b>	<b>NCA</b> <b>RM</b> <b>RSB</b> <b>OL</b> <b>GAV</b> <b>GTO</b> <b>BI</b>	<b>AL</b> <b>NR</b> <b>BI</b> <b>GAV</b>	180 x 85 x 54,7	2	0,855	101,0	<b>977,00</b>
 <p><b>Mobile di servizio portante N°3 cassettoni +anta+zona a giorno frontale</b>  <i>Load bearing service cabinet N°3 drawers + door+open case</i>  <b>Meuble de service porteur avec N°3 tiroirs+porte+compt. à jour</b></p>	<b>S0421</b> <b>DX-SX</b>	<b>NCA</b> <b>RM</b> <b>RSB</b> <b>OL</b> <b>GAV</b> <b>GTO</b> <b>BI</b>	<b>AL</b> <b>NR</b> <b>BI</b> <b>GAV</b>	180 x 85 x 54,7	2	0,855	103,0	<b>985,00</b>
 <p><b>Coppia ante frontali per articoli S0420-421</b>  <i>Jeu of frontal doors for article S0420-421</i>  <b>Jeu de portes frontales pour art. S0420-421</b></p>	<b>S0425</b>	<b>NCA</b> <b>RM</b> <b>RSB</b> <b>OL</b> <b>GAV</b> <b>GTO</b> <b>BI</b>			1	0,018	5,0	<b>50,00</b>
 <p><b>Coppia ante laterali per articoli S0420-421</b>  <i>Jeu of side doors for article S0420-421</i>  <b>Jeu de portes latérales pour art. S0420-421</b></p>	<b>S0426</b>	<b>NCA</b> <b>RM</b> <b>RSB</b> <b>OL</b> <b>GAV</b> <b>GTO</b> <b>BI</b>			1	0,023	7,0	<b>59,00</b>

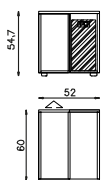
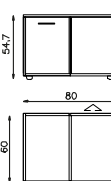
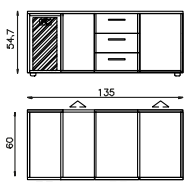
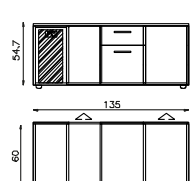

## MOBILI E CONTENITORI

MOBILI DI SERVIZIO BIFACCIALI PORTANTI H.54,7 LOAD BEARING CABINETS DOUBLE FACE H.54,7 MEUBLES DE RANGEMENT PORTEURS DOUBLE FACE H.54,7	CODICE CODE CODE	TOP FRONT. SCHEN. OP.FRONTAL FINISHING FIN. PLANS TIROIRS	FIN. SCOCCA STRUCTURE FINISHING FIN. STRUCT.	L x P x H. W x D x H. L x P x H.	COLLI PACKS COLIS	VOLUMI VOLUME VOLUME	PESO WEIGHT POIDS	PREZZO PRICE PRIX €
 <p><b>Mobile BIFACCIALE portante N°2 porta pc</b> <i>Cabinet double face N°2 cpu case</i> Meuble DOUBLE FACE N°2 cpus</p>	<b>S0430</b>	NCA RM RSB OL GAV GTO BI	AL NR BI GAV	52 x 60 x 54,7	1	0,181	19,0	<b>115,00</b>
 <p><b>Mobile BIFACCIALE portante N°2 ante</b> <i>Cabinet double face N°2 doors</i> Meuble DOUBLE FACE N°2 portes</p>	<b>S0431</b>	NCA RM RSB OL GAV GTO BI	AL NR BI GAV	80 x 60 x 54,7	1	0,275	32,0	<b>259,00</b>
 <p><b>Mobile BIFACCIALE portante N°2 cassettiere + 2 porta pc</b> <i>Cabinet double face N°2 drawers pedestal + 2 pcu case</i> Meuble de service porteur avec N°2 tiroirs +2 porte cpu</p>	<b>S0432</b>	NCA RM RSB OL GAV GTO BI	AL NR BI GAV	135 x 60 x 54,7	1	0,459	67,5	<b>693,00</b>
 <p><b>Mobile BIFACCIALE portante N°2 cassettiere con classificatore + 2 porta pc</b> <i>Cabinet double face N°2 drawers pedestal with filing + 2 pcu case</i> Meuble de service porteur avec N°2 tiroirs avec classer + 2 porte cpu</p>	<b>S0432.1</b>	NCA RM RSB OL GAV GTO BI	AL NR BI GAV	135 x 60 x 54,7	1	0,459	67,5	<b>693,00</b>

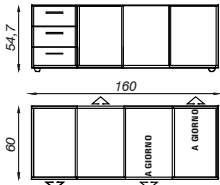
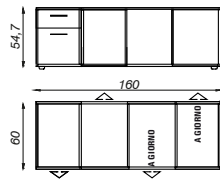
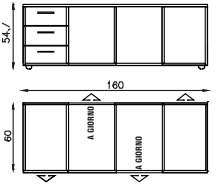
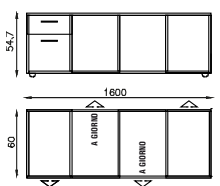

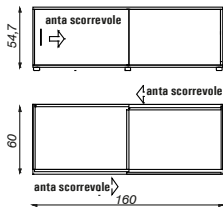
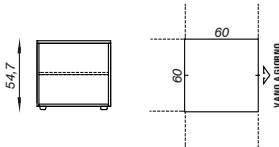
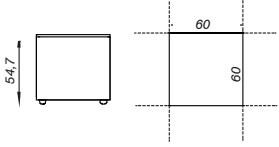

## MOBILI E CONTENITORI

<b>MOBILI DI SERVIZIO BIFACCIALI PORTANTI H.54,7</b> <b>LOAD BEARING CABINETS DOUBLE FACE H.54,7</b> <b>MEUBLES DE RANGEMENT PORTEURS DOUBLE FACE H.54,7</b>	<b>CODICE</b> <b>CODE</b> <b>CODE</b>	<small>FIN. TOP FRONT - SCHEN. TOP - FRONTAL FINISHING FIN. PLANS-TIROIRS</small>	<small>FIN. SCOCCA STRUCTURE FINISHING FIN. STRUCT.</small>	<b>L x P x H.</b> <b>W x D x H.</b> <b>L x P x H.</b>	<b>COLLI</b> <b>PACKS</b> <b>COLIS</b>	<b>VOLUMI</b> <b>VOLUME</b> <b>VOLUME</b>	<b>PESO</b> <b>WEIGHT</b> <b>POIDS</b>	<b>PREZZO</b> <b>PRICE</b> <b>PRIX</b> <b>€</b>
 <p><b>Mobile BIFACCIALE portante N°2 cassettiere + 2 zone a giorno</b>  <i>Cabinet double face N°2 drawers pedestal + 2 open case</i>  <b>Meuble de service porteur avec N°2 tiroirs + 2 compt. à jour</b></p>	<b>S0433</b>	<b>NCA</b> <b>RM</b> <b>RSB</b> <b>OL</b> <b>GAV</b> <b>GTO</b> <b>BI</b>	<b>AL</b> <b>NR</b> <b>BI</b> <b>GAV</b>	160 x 60 x 54,7	1	0,542	75,0	<b>776,00</b>
 <p><b>Mobile BIFACCIALE portante N°2 cassettiere con classificatore + 2 zone a giorno</b>  <i>Cabinet double face N°2 drawers pedestal with filing + 2 open case</i>  <b>Meuble de service porteur avec N°2 tiroirs avec classeur + 2 compt. à jour</b></p>	<b>S0433.1</b>	<b>NCA</b> <b>RM</b> <b>RSB</b> <b>OL</b> <b>GAV</b> <b>GTO</b> <b>BI</b>	<b>AL</b> <b>NR</b> <b>BI</b> <b>GAV</b>	160 x 60 x 54,7	1	0,542	75,0	<b>776,00</b>
 <p><b>Mobile BIFACCIALE portante N°2 cassettiere + 2 zone a giorno</b>  <i>Cabinet double face N°2 drawers pedestal + 2 open case</i>  <b>Meuble de service porteur avec N°2 tiroirs + 2 compt. à jour</b></p>	<b>S0434</b>	<b>NCA</b> <b>RM</b> <b>RSB</b> <b>OL</b> <b>GAV</b> <b>GTO</b> <b>BI</b>	<b>AL</b> <b>NR</b> <b>BI</b> <b>GAV</b>	160 x 60 x 54,7	1	0,542	75,0	<b>776,00</b>
 <p><b>Mobile BIFACCIALE portante N°2 cassettiere con classificatore + 2 zone a giorno</b>  <i>Cabinet double face N°2 drawers pedestal with filing + 2 open case</i>  <b>Meuble de service porteur avec N°2 tiroirs avec classeur + 2 compt. à jour</b></p>	<b>S0434.1</b>	<b>NCA</b> <b>RM</b> <b>RSB</b> <b>OL</b> <b>GAV</b> <b>GTO</b> <b>BI</b>	<b>AL</b> <b>NR</b> <b>BI</b> <b>GAV</b>	160 x 60 x 54,7	1	0,542	75,0	<b>776,00</b>

## MOBILI E CONTENITORI

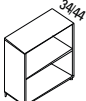

MOBILI DI SERVIZIO BIFACCIALI PORTANTI H.54,7 LOAD BEARING CABINETS DOUBLE FACE H.54,7 MEUBLES DE RANGEMENT PORTEURS DOUBLE FACE H.54,7	CODICE CODE CODE	FIN. TOP FRONT: SCHEN. TOP FRONTAL FINISHING FIN. PLANS-TIROIRS	FIN. SCOCCA STRUCTURE FINISHING FIN. STRUCT.	L x P x H. W x D x H. L x P x H.	COLLI PACKS COLIS	VOLUMI VOLUME VOLUME	PESO WEIGHT POIDS	PREZZO PRICE PRIX €
 <p><b>Mobile BIFACCIALE portante N°2 ante scorrevoli</b> <i>Cabinet double face N°2 sliding doors</i> Meuble de service porteur avec N°2 portes coulissantes</p>	<b>S0435</b>	NCA RM RSB OL GAV GTO BI	AL NR BI GAV	160 x 60 x 54,7	1	0,542	75,0	<b>477,00</b>
 <p><b>Mobile angolare 2/3 vie con 1 zona a giorno</b> <i>2/3 way cabinet with 1 open compartment</i> Meuble à angle 2/3 voies avec compartiment à jour</p>	<b>S0436</b>	NCA RM RSB OL GAV GTO BI	AL NR BI GAV	60 x 60 x 54,7	1	0,049	22,0	<b>116,00</b>
 <p><b>Mobile angolare 4 vie tutto chiuso</b> <i>4 way closed cabinet</i> Meuble à angle 4 voies tout fermé</p>	<b>S0437</b>	NCA RM RSB OL GAV GTO BI	AL NR BI GAV	60 x 60 x 54,7	1	0,219	23,0	<b>125,00</b>
 <p><b>Chiusura soft per cassettera (Kit x 3 cassetti)</b> <i>Soft close mechanism (3 drawer kit)</i> Fermeture amortie (kit pour 3 tiroirs)</p>	<b>S0250</b>		PORTATA MAX CASSETTO 20 Kg MAXIMUM WEIGHT X DRAWER 20 Kgs CAPACITE MAXIMALE TIROIR 20 Kgs					<b>36,00</b>
 <p><b>Maniglia cromata per ante legno</b> <i>Handle chromed for wooden desk</i> Poignée chromé pour portes mélaminé</p>	<b>AC110</b>	BI CR NR						<b>6,00</b> PER DIFFERENZA FOR DIFFERENCE DE LA DIFFÉRENCE

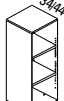
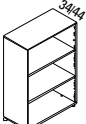
**MOBILI E CONTENITORI**

<b>CONTENITORI PROF.34/44</b> <i>CABINETS DEPTH 34/44</i> <b>ARMOIRES PROFONDEUR 34/44</b>		<b>CODICE</b> <i>CODE</i> <b>CODE</b>	<small>FIN. FRONTALI</small> <small>FRONTAL FINISHING</small> <small>FIN. TIROIRS</small>	<small>FIN. SCOCCA</small> <small>STRUCTURE</small> <small>FINISHING</small> <small>FIN. STRUCT.</small>	<b>L x P x H.</b> <i>W x D x H.</i> <b>L x P x H.</b>	<b>COLLI</b> <i>PACKS</i> <b>COLIS</b>	<b>VOLUMI</b> <i>VOLUME</i> <b>VOLUME</b>	<b>PESO</b> <i>WEIGHT</i> <b>POIDS</b>	<b>PREZZO</b> <i>PRICE</i> <i>PRIX</i> <b>€</b>
 <b>H.80,8</b>	<b>S0102</b>		<b>AL</b> <b>NR</b> <b>BI</b> <b>GAV</b>	45 x 34 x 80,8	1	0,040	14,0	<b>76,00</b>	
	<b>S0102.1</b>			45 x 44 x 80,8	1	0,044	18,2	<b>93,00</b>	
 <b>H.80,8</b>	<b>S0103</b>		<b>AL</b> <b>NR</b> <b>BI</b> <b>GAV</b>	90 x 34 x 80,8	1	0,061	21,7	<b>114,00</b>	
	<b>S0103.1</b>			90 x 44 x 80,8	1	0,067	29,0	<b>139,00</b>	
 <b>H.80,8</b>	<b>S0160.1</b>	<b>NCA</b> <b>RM</b> <b>RSB</b> <b>OL</b> <b>GAV</b> <b>GTO</b> <b>BI</b>	<b>AL</b> <b>NR</b> <b>BI</b> <b>GAV</b>	45 x 44 x 80,8	1	0,187	35,0	<b>288,00</b>	
 <b>H.80,8</b>	<b>S0161.1</b>	<b>NCA</b> <b>RM</b> <b>RSB</b> <b>OL</b> <b>GAV</b> <b>GTO</b> <b>BI</b>	<b>AL</b> <b>NR</b> <b>BI</b> <b>GAV</b>	90 x 46 x 80,8	1	0,366	64,5	<b>373,00</b>	
 <b>H.80,8</b>	<b>S0162.1</b>	<b>NCA</b> <b>RM</b> <b>RSB</b> <b>OL</b> <b>GAV</b> <b>GTO</b> <b>BI</b>	<b>AL</b> <b>NR</b> <b>BI</b> <b>GAV</b>	90 x 46 x 80,8	1	0,366	57,5	<b>488,00</b>	
 <b>H.119,2</b>	<b>S0104</b>		<b>AL</b> <b>NR</b> <b>BI</b> <b>GAV</b>	45 x 34 x 119,2	1	0,054	25,0	<b>106,00</b>	
	<b>S0104.1</b>			45 x 44 x 119,2	1	0,056	29,4	<b>130,00</b>	
 <b>H.119,2</b>	<b>S0105</b>		<b>AL</b> <b>NR</b> <b>BI</b> <b>GAV</b>	90 x 34 x 119,2	1	0,092	35,7	<b>159,00</b>	
	<b>S0105.1</b>			90 x 44 x 119,2	1	0,099	42,0	<b>193,00</b>	

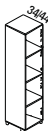
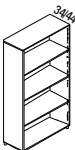

**MOBILI E CONTENITORI**

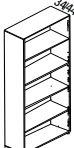
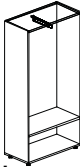
<b>CONTENITORI PROF.34/44</b> <b>CABINETS DEPTH 34/44</b> <b>ARMOIRES PROFONDEUR 34/44</b>	<b>CODICE</b> <b>CODE</b> <b>CODE</b>	<small>FIN. FRONTALI</small> <small>FRONTAL FINISHING</small> <small>FIN. TIRORS</small>	<small>FIN. SCOCCA</small> <small>STRUCTURE</small> <small>FINISHING</small> <small>FIN. STRUCT.</small>	<b>L x P x H.</b> <b>W x D x H.</b> <b>L x P x H.</b>	<b>COLLI</b> <b>PACKS</b> <b>COLIS</b>	<b>VOLUMI</b> <b>VOLUME</b> <b>VOLUME</b>	<b>PESO</b> <b>WEIGHT</b> <b>POIDS</b>	<b>PREZZO</b> <b>PRICE</b> <b>PRICE</b>
								<b>€</b>
 <b>H.158,8</b> <b>Contenitore medio a giorno L.45</b> <i>Medium cabinet L.45</i> Armoire moyenne à jour L.45	<b>S0106</b>		<b>AL</b> <b>NR</b> <b>BI</b> <b>GAV</b>	45 x 34 x 158,8	1	0,076	30,0	<b>135,00</b>
	<b>S0106.1</b>			45 x 44 x 158,8	1	0,088	35,7	<b>167,00</b>
 <b>H.158,8</b> <b>Contenitore medio a giorno L.90</b> <i>Medium cabinet L.90</i> Armoire moyenne à jour L.90	<b>S0107</b>		<b>AL</b> <b>NR</b> <b>BI</b> <b>GAV</b>	90 x 34 x 158,8	1	0,115	43,3	<b>203,00</b>
	<b>S0107.1</b>			90 x 44 x 158,8	1	0,161	51,0	<b>247,00</b>
 <b>H.197,2</b> <b>Contenitore alto a giorno L.45</b> <i>High cabinet L.45</i> Armoire haute à jour L.45	<b>S0108</b>		<b>AL</b> <b>NR</b> <b>BI</b> <b>GAV</b>	45 x 34 x 197,2	1	0,089	33,0	<b>165,00</b>
	<b>S0108.1</b>			45 x 44 x 197,2	1	0,100	41,0	<b>204,00</b>
 <b>H.197,2</b> <b>Contenitore alto a giorno L.90</b> <i>High cabinet L.90</i> Armoire haute à jour L.90	<b>S0109</b>		<b>AL</b> <b>NR</b> <b>BI</b> <b>GAV</b>	90 x 34 x 197,2	2	0,115	51,0	<b>247,00</b>
	<b>S0109.1</b>			90 x 44 x 197,2	2	0,127	60,0	<b>298,00</b>
 <b>S0165.1</b> <b>Contenitore guardaroba con appendiabito estraibile</b> <i>Wardrobe with pull-out coathanger</i> Armoire vestiaire avec portmanteau escamotable			<b>AL</b> <b>NR</b> <b>BI</b> <b>GAV</b>	90 x 44 x 197,2	2	0,127	52,0	<b>242,00</b>

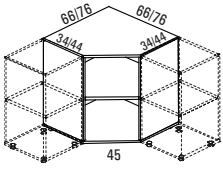
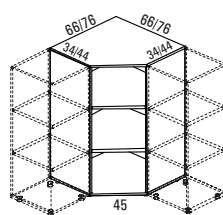
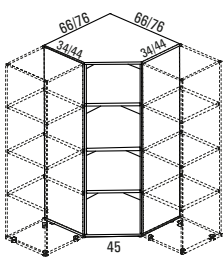
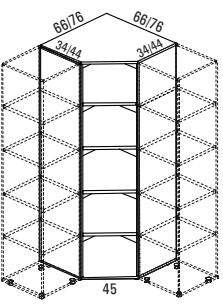

## MOBILI E CONTENITORI

CONTENITORI AD ANGOLO PROF.34/44 CORNER CABINETS DEPTH 34/44 CORNER ARMOIRES PROFONDEUR 34/44	CODICE CODE CODE	FIN. FRONTALI FRONTAL FINISHING FIN. TIROIRS	FIN. SCOCCA STRUCTURE FINISHING FIN. STRUCT.	L x P x H. W x D x H. L x P x H.	COLLI PACKS COLIS	VOLUMI VOLUME VOLUME	PESO WEIGHT POIDS	PREZZO PRICE PRIX
								€
<p><b>H.80,8</b></p>  <p><b>Angolo interno per contenitore basso H.80,8</b> <i>Internal corner for low cabinets H.80,8</i> <i>Angle interne pour armoire basse H.80,8</i></p>	<b>S0110</b>	AL NR BI GAV		66 x 66 x 80,8 P.34	3	0,391	34,3	<b>228,00</b>
	<b>S0110.1</b>			76 x 76 x 80,8 P.44	3	0,471	52,8	<b>274,00</b>
<p><b>H.119,2</b></p>  <p><b>Angolo interno per contenitore medio H.119,2</b> <i>Internal corner for medium cabinets H.119,2</i> <i>Angle interne pour armoire moyenne H.119,2</i></p>	<b>S0111</b>	AL NR BI GAV		66 x 66 x 119,2 P.34	3	0,587	60,3	<b>316,00</b>
	<b>S0111.1</b>			76 x 76 x 119,2 P.44	3	0,706	76,1	<b>384,00</b>
<p><b>H.158,8</b></p>  <p><b>Angolo interno per contenitore medio H.158,8</b> <i>Internal corner for medium cabinets H.158,8</i> <i>Angle interne pour armoire moyenne H.158,8</i></p>	<b>S0112</b>	AL NR BI GAV		66 x 66 x 158,8 P.34	4	0,809	78,8	<b>406,00</b>
	<b>S0112.1</b>			76 x 76 x 158,8 P.44	4	0,973	99,3	<b>492,00</b>
<p><b>H.197,2</b></p>  <p><b>Angolo interno per contenitore alto H.197,2</b> <i>Internal corner for high cabinets H.197,2</i> <i>Angle interne pour armoire haute H.197,2</i></p>	<b>S0113</b>	AL NR BI GAV		66 x 66 x 197,2 P.34	4	0,991	97,2	<b>494,00</b>
	<b>S0113.1</b>			76 x 76 x 197,2 P.44	4	1,192	122,5	<b>594,00</b>

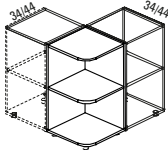
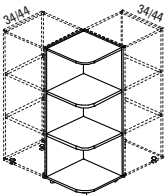
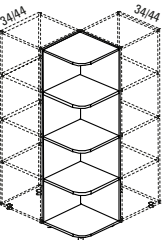
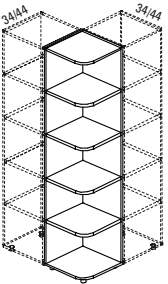
**MOBILI E CONTENITORI**

<b>CONTENITORI AD ANGOLO PROF.34/44</b> <i>CORNER CABINETS DEPTH 34/44</i> <b>CORNER ARMOIRES PROFONDEUR 34/44</b>		<b>CODICE</b> <i>CODE</i> <b>CODE</b>	<small>FIN. FRONTALI</small> <small>FRONTAL FINISHING</small> <small>FIN. TIRORS</small>	<small>FIN. SCOCCA</small> <small>STRUCTURE</small> <small>FINISHING</small> <small>FIN. STRUCT.</small>	<b>L x P x H.</b> <i>W x D x H.</i> <b>L x P x H.</b>	<b>COLLI</b> <i>PACKS</i> <b>COLIS</b>	<b>VOLUMI</b> <i>VOLUME</i> <b>VOLUME</b>	<b>PESO</b> <i>WEIGHT</i> <b>POIDS</b>	<b>PREZZO</b> <i>PRICE</i> <i>PRIX</i> <b>€</b>
 <p><b>H.80,8</b></p> <p><b>Angolo esterno per contenitore basso H.80,8</b> <i>External corner for low cabinets H.80,8</i> <i>Angle externe pour armoire basse H.80,8</i></p>	<b>S0115</b>			<b>AL</b> <b>NR</b> <b>BI</b> <b>GAV</b>	34 x 34 x 80,8 P.34	2	0,133	12,8	<b>258,00</b>
	<b>S0115.1</b>				44 x 44 x 80,8 P.44	2	0,173	18,7	<b>308,00</b>
 <p><b>H.119,2</b></p> <p><b>Angolo esterno per contenitore medio H.119,2</b> <i>External corner for medium cabinets H.119,2</i> <i>Angle externe pour armoire moyenne H.119,2</i></p>	<b>S0116</b>			<b>AL</b> <b>NR</b> <b>BI</b> <b>GAV</b>	34 x 34 x 119,2 P.34	2	0,200	18,6	<b>346,00</b>
	<b>S0116.1</b>				44 x 44 x 119,2 P.44	2	0,260	27,0	<b>424,00</b>
 <p><b>H.158,2</b></p> <p><b>Angolo esterno per contenitore medio H.158,8</b> <i>External corner for medium cabinets H.158,8</i> <i>Angle externe pour armoire moyenne H.158,8</i></p>	<b>S0117</b>			<b>AL</b> <b>NR</b> <b>BI</b> <b>GAV</b>	34 x 34 x 158,8 P.34	3	0,275	24,4	<b>456,00</b>
	<b>S0117.1</b>				44 x 44 x 158,8 P.44	3	0,359	35,3	<b>542,00</b>
 <p><b>H.197,2</b></p> <p><b>Angolo esterno per contenitore alto H.197,2</b> <i>External corner for high cabinets H.197,2</i> <i>Angle externe pour armoire haute H.197,2</i></p>	<b>S0118</b>			<b>AL</b> <b>NR</b> <b>BI</b> <b>GAV</b>	34 x 34 x 197,2 P.34	4	0,991	97,2	<b>494,00</b>
	<b>S0118.1</b>				44 x 44 x 197,2 P.44	3	0,338	30,2	<b>554,00</b>

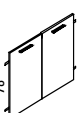
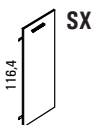
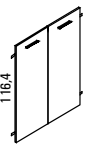
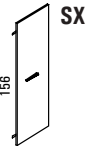

**MOBILI E CONTENITORI**

<b>ANTE LEGNO</b> <b>WOODEN DOORS</b> <b>PORTES mélaminé</b>	<b>CODICE</b> <b>CODE</b> <b>CODE</b>	<small>FIN. ANTE DOORS FINISHING Finition PORTES</small>		<b>L x H x SP.</b> <b>W x H x TH.</b> <b>L x H x EP.</b>	<b>COLLI</b> <b>PACKS</b> <b>COLIS</b>	<b>VOLUMI</b> <b>VOLUME</b> <b>VOLUME</b>	<b>PESO</b> <b>WEIGHT</b> <b>POIDS</b>	<b>PREZZO</b> <b>PRICE</b> <b>PRIX</b> <b>€</b>
 <p><b>Anta bassa con serratura</b>  <i>Low door with lock</i>  Porte basse avec serrure</p>	<b>S0121</b> <b>DX-SX</b>	<b>NCA</b> <b>RM</b> <b>RSB</b> <b>OL</b> <b>GAV</b> <b>GTO</b> <b>BI</b>		45 x 78 x 1,8 <b>Contenitori H.80,8</b> <i>Cabinets H.80,8</i> Armoires H.80,8	1	0,009	6,0	<b>47,00</b>
 <p><b>Coppia ante basse</b>  <i>Pair of low doors with lock</i>  Jeu de portes basses avec serrure</p>	<b>S0121.2</b>	<b>NCA</b> <b>RM</b> <b>RSB</b> <b>OL</b> <b>GAV</b> <b>GTO</b> <b>BI</b>		2 x 45 x 78 x 1,8 <b>Contenitori H.80,8</b> <i>Cabinets H.80,8</i> Armoires H.80,8	1	0,024	11,0	<b>90,00</b>
 <p><b>Anta media con serratura</b>  <i>Medium door with lock</i>  Porte moyenne avec serrure</p>	<b>S0122</b> <b>DX-SX</b>	<b>NCA</b> <b>RM</b> <b>RSB</b> <b>OL</b> <b>GAV</b> <b>GTO</b> <b>BI</b>		45 x 116,4 x 1,8 <b>Contenitori H.119,2</b> <i>Cabinets H.119,2</i> Armoires H.119,2	1	0,035	8,0	<b>56,00</b>
 <p><b>Coppia ante medie con serratura</b>  <i>Pair of medium doors with lock</i>  Jeu de portes moyennes avec serrure</p>	<b>S0122.2</b>	<b>NCA</b> <b>RM</b> <b>RSB</b> <b>OL</b> <b>GAV</b> <b>GTO</b> <b>BI</b>		2 x 45 x 116,4 x 1,8 <b>Contenitori H.119,2</b> <i>Cabinets H.119,2</i> Armoires H.119,2	1	0,035	15,0	<b>111,00</b>
 <p><b>Anta media con serratura</b>  <i>Medium door with lock</i>  Porte moyenne avec serrure</p>	<b>S0123</b> <b>DX-SX</b>	<b>NCA</b> <b>RM</b> <b>RSB</b> <b>OL</b> <b>GAV</b> <b>GTO</b> <b>BI</b>		45 x 156 x 1,8 <b>Contenitori H.158,8</b> <i>Cabinets H.158,8</i> Armoires H.158,8	1	0,046	10,0	<b>67,00</b>
 <p><b>Coppia ante medie con serratura</b>  <i>Pair of medium doors with lock</i>  Jeu de portes moyennes avec serrure</p>	<b>S0123.2</b>	<b>NCA</b> <b>RM</b> <b>RSB</b> <b>OL</b> <b>GAV</b> <b>GTO</b> <b>BI</b>		2 x 45 x 156 x 1,8 <b>Contenitori H.158,8</b> <i>Cabinets H.158,8</i> Armoires H.158,8	1	0,046	19,0	<b>133,00</b>

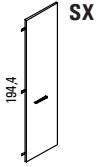
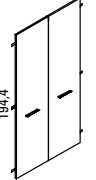
## MOBILI E CONTENITORI

ANTE LEGNO WOODEN DOORS PORTES mélaminé	CODICE CODE CODE	FIN. ANTE DOORS FINISHING FINITION PORTES	L x H x SP. W x H x TH. L x H x EP.	COLLI PACKS COLIS	VOLUMI VOLUME VOLUME	PESO WEIGHT POIDS	PREZZO PRICE PRIX €
 <p><b>Anta alta con serratura</b> <i>High door with lock</i> <b>Porte haute avec serrure</b></p>	<b>S0124 DX-SX</b>	<b>NCA RM RSB OL GAV GTO BI</b>	45 x 194,4 x 1,8 Contenitori H.197,2 <i>Cabinets H.197,2</i> Armoires H.197,2	1	0,057	12,0	<b>84,00</b>
 <p><b>Coppia ante alte con serratura</b> <i>Pair of high door with lock</i> <b>Jeu de portes hautes avec serrure</b></p>	<b>S0124.2</b>	<b>NCA RM RSB OL GAV GTO BI</b>	2 x 45 x 194,4 x 1,8 Contenitori H.197,2 <i>Cabinets H.197,2</i> Armoires H.197,2	1	0,057	23,0	<b>167,00</b>

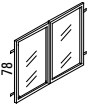
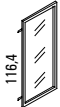
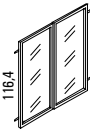
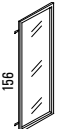
## MOBILI E CONTENITORI

ANTE VETRO CON TELAIO ALLUMINIO GLASS DOORS WITH ALUMINIUM FRAME PORTES EN VERRE AVEC BATI EN ALUMINIUM	CODICE CODE CODE	FIN. TELAIO FRAME FINISHING FINITION BATI	FIN. VETRO GLASS FINISHING FINITION VERRE	L x H x SP. W x H x TH. L x H x EP.	COLLI PACKS COLIS	VOLUMI VOLUME VOLUME	PESO WEIGHT POIDS	PREZZO PRICE PRIX
								€
 <p><b>Anta bassa vetro con telaio alluminio</b> <i>Low glass door with aluminium frame</i> Porte basse en verre avec bati en aluminium</p>	S0131	AL	VT	45 x 78 x 1,8 Contenitori H.80,8 Cabinets H.80,8 Armoires H.80,8	1	0,024	3,5	112,00
			VS					124,00
 <p><b>Coppia ante basse vetro con telaio alluminio</b> <i>Pair of low glass doors with aluminium frame</i> Jeu de portes basses avec bati en aluminium</p>	S0131.2	AL	VT	2 x 45 x 78 x 1,8 Contenitori H.80,8 Cabinets H.80,8 Armoires H.80,8	1	0,024	7,0	220,00
			VS					244,00
 <p><b>Anta media vetro con telaio alluminio</b> <i>Medium glass door with aluminium frame</i> Porte moyenne en verre avec bati en aluminium</p>	S0132	AL	VT	45 x 116,4 x 1,8 Contenitori H.119,2 Cabinets H.119,2 Armoires H.119,2	1	0,035	7,5	140,00
			VS					159,00
 <p><b>Coppia ante medie vetro con telaio alluminio</b> <i>Pair of medium glass doors with aluminium frame</i> Jeu de portes moyennes avec bati en aluminium</p>	S0132.2	AL	VT	2 x 45 x 116,4 x 1,8 Contenitori H.119,2 Cabinets H.119,2 Armoires H.119,2	1	0,035	14,0	274,00
			VS					312,00
 <p><b>Anta media vetro con telaio alluminio</b> <i>Medium glass door with aluminium frame</i> Porte moyenne en verre avec bati en aluminium</p>	S0133	AL	VT	45 x 156 x 1,8 Contenitori H.158,8 Cabinets H.158,8 Armoires H.158,8	1	0,046	9,0	164,00
			VS					188,00
 <p><b>Coppia ante medie vetro con telaio alluminio</b> <i>Pair of medium glass doors with aluminium frame</i> Jeu de portes moyennes avec bati en aluminium</p>	S0133.2	AL	VT	2 x 45 x 156 x 1,8 Contenitori H.158,8 Cabinets H.158,8 Armoires H.158,8	1	0,046	18,0	320,00
			VS					370,00

## MOBILI E CONTENITORI

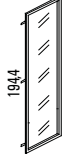
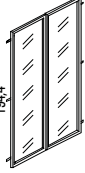
ANTE VETRO CON TELAIO ALLUMINIO GLASS DOORS WITH ALUMINIUM FRAME PORTES EN VERRE AVEC BATI EN ALUMINIUM	CODICE CODE CODE	FIN. TELAIO FRAME FINISHING FINITION BATI	FIN. VETRO GLASS FINISHING FINITION VERRE	L x H x SP. W x H x TH. L x H x EP.	COLLI PACKS COLIS	VOLUMI VOLUME VOLUME	PESO WEIGHT POIDS	PREZZO PRICE PRIX
								€
 <p><b>Anta alta vetro con telaio alluminio</b> <i>High glass door with aluminium frame</i> Porte haute en verre avec bati en aluminium</p>	<b>S0134</b>	<b>AL</b>	<b>VT</b>	45 x 194,4 x 1,8 Contenitori H.197,2 Cabinets H.197,2 Armoires H.197,2	1	0,057	11,0	<b>220,00</b>
			<b>VS</b>					<b>250,00</b>
 <p><b>Coppia ante alte vetro con telaio alluminio</b> <i>Pair of high glass doors with aluminium frame</i> Jeu de portes hautes avec bati en aluminium</p>	<b>S0134.2</b>	<b>AL</b>	<b>VT</b>	2 x 45 x 194,4 x 1,8 Contenitori H.197,2 Cabinets H.197,2 Armoires H.197,2	1	0,057	22,0	<b>431,00</b>
			<b>VS</b>					<b>492,00</b>

**MOBILI E CONTENITORI**

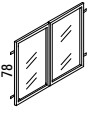
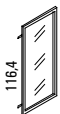
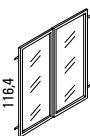
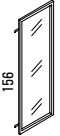
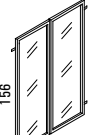
ANTE VETRO CON TELAIO VERNICIATO NERO GLASS DOORS WITH BLACK VARNISHED FRAME PORTES EN VERRE AVEC BATI EN VERNI NOIR	CODICE CODE CODE	FIN. TELAIO FRAME FINISHING FINITION BATI	FIN. VETRO GLASS FINISHING FINITION VERRE	L x H x SP. W x H x TH. L x H x EP.	COLLI PACKS COLIS	VOLUMI VOLUME VOLUME	PESO WEIGHT POIDS	PREZZO PRICE PRIX
								€
 <p><b>Anta bassa vetro con telaio verniciato nero</b> <i>Low glass door with black varnished frame</i> <i>Porte basse en verre avec bati en verni noir</i></p>	S0136	NR	VT	45 x 78 x 1,8 Contenitori H.80,8 Cabinets H.80,8 Armoires H.80,8	1	0,024	3,5	134,00
			VS					146,00
 <p><b>Coppia ante basse vetro con telaio verniciato nero</b> <i>Pair of low glass doors with black varnished frame</i> <i>Jeu de portes basses avec bati en verni noir</i></p>	S0136.2	NR	VT	2 x 45 x 78 x 1,8 Contenitori H.80,8 Cabinets H.80,8 Armoires H.80,8	1	0,024	7,0	264,00
			VS					285,00
 <p><b>Anta media vetro con telaio verniciato nero</b> <i>Medium glass door with black varnished frame</i> <i>Porte moyenne en verre avec bati en verni noir</i></p>	S0137	NR	VT	45 x 116,4 x 1,8 Contenitori H.119,2 Cabinets H.119,2 Armoires H.119,2	1	0,035	7,5	168,00
			VS					187,00
 <p><b>Coppia ante medie vetro con telaio verniciato nero</b> <i>Pair of medium glass doors with black varnished frame</i> <i>Jeu de portes moyennes avec bati en verni noir</i></p>	S0137.2	NR	VT	2 x 45 x 116,4 x 1,8 Contenitori H.119,2 Cabinets H.119,2 Armoires H.119,2	1	0,035	14,0	330,00
			VS					368,00
 <p><b>Anta media vetro con telaio verniciato nero</b> <i>Medium glass door with black varnished frame</i> <i>Porte moyenne en verre avec bati en verni noir</i></p>	S0138	NR	VT	45 x 156 x 1,8 Contenitori H.158,8 Cabinets H.158,8 Armoires H.158,8	1	0,046	9,0	196,00
			VS					221,00
 <p><b>Coppia ante medie vetro con telaio verniciato nero</b> <i>Pair of medium glass doors with black varnished frame</i> <i>Jeu de portes moyennes avec bati verni noir</i></p>	S0138.2	NR	VT	2 x 45 x 156 x 1,8 Contenitori H.158,8 Cabinets H.158,8 Armoires H.158,8	1	0,046	18,0	386,00
			VS					435,00

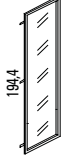
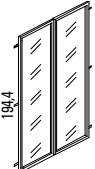

## MOBILI E CONTENITORI

ANTE VETRO CON TELAIO VERNICIATO NERO GLASS DOORS WITH BLACK VARNISHED FRAME PORTES EN VERRE AVEC BATI EN VERNI NOIR	CODICE CODE CODE	FIN. TELAIO FRAME FINISHING FINITION BATI	FIN. VETRO GLASS FINISHING FINITION VERRE	L x H x SP. W x H x TH. L x H x EP.	COLLI PACKS COLIS	VOLUMI VOLUME VOLUME	PESO WEIGHT POIDS	PREZZO PRICE PRIX €
 <p><b>Anta alta vetro con telaio verniciato nero</b> <i>High glass door with black varnished frame</i> <i>Porte haute en verre avec bati en verni noir</i></p>	<b>S0139</b>	<b>NR</b>	<b>VT</b>	45 x 194,4 x 1,8 Contenitori H.197,2 Cabinets H.197,2 Armoires H.197,2	1	0,057	11,0	<b>264,00</b>
			<b>VS</b>					<b>294,00</b>
 <p><b>Coppia ante alte vetro con telaio verniciato nero</b> <i>Pair of high glass doors with black varnished frame</i> <i>Jeu de portes hautes avec bati en verni noir</i></p>	<b>S0139.2</b>	<b>NR</b>	<b>VT</b>	2 x 45 x 194,4 x 1,8 Contenitori H.197,2 Cabinets H.197,2 Armoires H.197,2	1	0,057	22,0	<b>519,00</b>
			<b>VS</b>					<b>579,00</b>

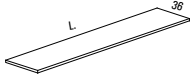
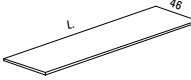
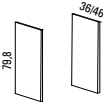
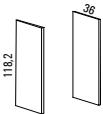
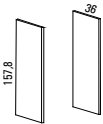
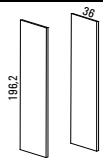

## MOBILI E CONTENITORI

TOP E FIANCHI FINALI TOP AND FINAL SIDES TOPS ET COTES	CODICE CODE CODE	FINITURA FINISHING FINISSAGE		L x P x SP. W x D x TH. L x P x EP.	COLLI PACKS COLIS	VOLUMI VOLUME VOLUME	PESO WEIGHT POIDS	PREZZO PRICE PRIX €
 <p><b>Top per contenitori Prof.34</b> Top for cabinets depth 34 Top pour armoire Profondeur 34</p>	<b>SO140</b>	<b>NCA</b>	2 - Ante-Door-Parte	45 x 36 x 1,8	1	0,007	2,3	<b>10,00</b>
	<b>SO141</b>	<b>RM</b>	2 - Ante-Doors-Portes	90 x 36 x 1,8	1	0,013	4,5	<b>20,00</b>
	<b>SO142</b>	<b>RSB</b>	3 - Ante-Doors-Portes	135,1 x 36 x 1,8	1	0,020	6,8	<b>30,00</b>
	<b>SO143</b>	<b>OL</b>	4 - Ante-Doors-Portes	180,1 x 36 x 1,8	1	0,026	9,1	<b>40,00</b>
	<b>SO144</b>	<b>GAV</b>	5 - Ante-Doors-Portes	225,2 x 36 x 1,8	1	0,033	11,4	<b>50,00</b>
	<b>SO145</b>	<b>GTO</b>	6 - Ante-Doors-Portes	270,2 x 36 x 1,8	1	0,039	13,6	<b>60,00</b>
	<b>BI</b>							
 <p><b>Top per contenitori Prof.44</b> Top for cabinets depth 44 Top pour armoire Profondeur 44</p>	<b>SO140.1</b>	<b>NCA</b>	2 - Ante-Door-Parte	45 x 46 x 1,8	1	0,009	2,9	<b>13,00</b>
	<b>SO141.1</b>	<b>RM</b>	2 - Ante-Doors-Portes	90 x 46 x 1,8	1	0,017	5,8	<b>26,00</b>
	<b>SO142.1</b>	<b>RSB</b>	3 - Ante-Doors-Portes	135,1 x 46 x 1,8	1	0,025	8,7	<b>39,00</b>
	<b>SO143.1</b>	<b>OL</b>	4 - Ante-Doors-Portes	180,1 x 46 x 1,8	1	0,033	11,6	<b>51,00</b>
	<b>SO144.1</b>	<b>GAV</b>	5 - Ante-Doors-Portes	225,2 x 46 x 1,8	1	0,041	14,5	<b>64,00</b>
	<b>SO145.1</b>	<b>GTO</b>	6 - Ante-Doors-Portes	270,2 x 46 x 1,8	1	0,050	17,4	<b>77,00</b>
	<b>BI</b>							
 <p><b>Coppia fianchi finali bassi</b> 2 low side panels Jeu de cotés de FINITIONbasses</p>	<b>SO171</b>	<b>NCA</b>	PER-FOR -POUR Contenitori H.80,8 Cabinets H.80,8 Armoires H.80,8	36 x H.79,8 x 1,8	1	0,024	8,0	<b>36,00</b>
	<b>SO171.1</b>	<b>OL</b>	PER-FOR -POUR Contenitori H.80,8 Cabinets H.80,8 Armoires H.80,8	46 x H.79,8 x 1,8	1	0,030	10,3	<b>45,00</b>
	<b>GAV</b>							
	<b>GTO</b>							
 <p><b>Coppia fianchi finali medi</b> 2 medium side panels Jeu de cotés de FINITIONmoyennes</p>	<b>SO172</b>	<b>NCA</b>	PER-FOR -POUR Contenitori H.119,2 Cabinets H.119,2 Armoires H.119,2	36 x H.118,2 x 1,8	1	0,030	10,3	<b>53,00</b>
	<b>SO172.1</b>	<b>OL</b>	PER-FOR -POUR Contenitori H.119,2 Cabinets H.119,2 Armoires H.119,2	46 x H.118,2 x 1,8	1	0,044	15,2	<b>67,00</b>
	<b>GAV</b>							
	<b>BI</b>							
 <p><b>Coppia fianchi finali medi</b> 2 medium side panels Jeu de cotés de FINITIONmoyennes</p>	<b>SO173</b>	<b>NCA</b>	PER-FOR -POUR Contenitori H.158,8 Cabinets H.158,8 Armoires H.158,8	36 x H.157,8 x 1,8	1	0,046	15,9	<b>70,00</b>
	<b>SO173.1</b>	<b>OL</b>	PER-FOR -POUR Contenitori H.158,8 Cabinets H.158,8 Armoires H.158,8	46 x H.157,8 x 1,8	1	0,058	20,3	<b>89,00</b>
	<b>GAV</b>							
	<b>GTO</b>							
 <p><b>Coppia fianchi finali alti</b> 2 high side panels Jeu de cotés de FINITIONhautes</p>	<b>SO174.1</b>	<b>NCA</b>	PER-FOR -POUR Contenitori H.197,2 Cabinets H.197,2 Armoires H.197,2	36 x H.196,2 x 1,8	1	0,057	19,8	<b>87,00</b>
	<b>SO174.1</b>	<b>OL</b>	PER-FOR -POUR Contenitori H.197,2 Cabinets H.197,2 Armoires H.197,2	46 x H.196,2 x 1,8	1	0,072	25,3	<b>111,00</b>
	<b>GAV</b>							
	<b>GTO</b>							

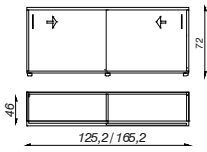
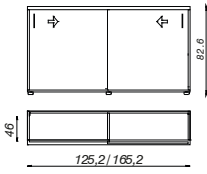
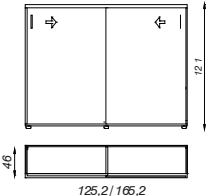
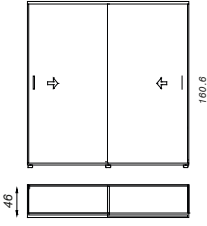



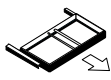

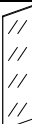
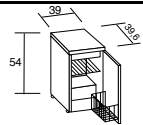
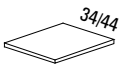
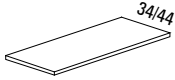
## MOBILI E CONTENITORI

CONTENITORI SCORREVOLI SLIDING CABINETS ARMOIRES COULISSANTES	CODICE CODE CODE	FIN. TOP FRONT- SCHEN. TOP FRONTAL FINISHING FIN. PLANS-TIROIRS	FIN. SCOCCA STRUCTURE FINISHING FIN. STRUCT.	L x P x H. W x D x H. L x P x H.	COLLI PACKS COLIS	VOLUMI VOLUME VOLUME	PESO WEIGHT POIDS	PREZZO PRICE PRIX
								€
 <p><b>Mobile basso con ante scorrevoli</b> <i>Low cabinet with sliding doors</i> Armoires basses avec portes coulissantes</p>	S0180.1	NCA RM RSB	AL NR BI GAV	125,2 x 46 x 72	2	0,120	56,0	385,00
	S0181.1	OL GAV GTO BI		165,2 x 46 x 72	2	0,135	74,0	470,00
 <p><b>Mobile basso con ante scorrevoli</b> <i>Low cabinet with sliding doors</i> Armoires basses avec portes coulissantes</p>	S0182.1	NCA RM RSB	AL NR BI GAV	125,2 x 46 x 82,6	2	0,130	69,0	424,00
	S0183.1	OL GAV GTO BI		165,2 x 46 x 82,6	2	0,145	90,0	517,00
 <p><b>Mobile medio con ante scorrevoli</b> <i>Medium cabinet with sliding doors</i> Armoires moyenne avec portes coulissantes</p>	S0184.1	NCA RM RSB	AL NR BI GAV	125,2 x 46 x 121	3	0,228	95,0	614,00
	S0185.1	OL GAV GTO BI		165,2 x 46 x 121	3	0,243	125,0	748,00
 <p><b>Mobile medio con ante scorrevoli</b> <i>Medium cabinet with sliding doors</i> Armoires moyenne avec portes coulissantes</p>	S0186.1	NCA RM RSB	AL NR BI GAV	125,2 x 46x160,6	3	0,300	129,0	913,00
	S0187.1	OL GAV GTO BI		165,2 x 46x160,6	3	0,315	170,0	1.113,00

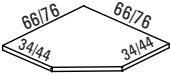
## MOBILI E CONTENITORI

ACCESSORI PER CONTENITORI ECESSOIRES FOR CABINETS ACCESSOIRES POUR ARMOIRES	CODICE CODE CODE		FIN. SCOCCA STRUCTURE FINISHING FIN. STRUCT.	L x P x H. W x D x H. L x P x H.	COLLI PACKS COLIS	VOLUMI VOLUME VOLUME	PESO WEIGHT POIDS	PREZZO PRICE PRIX €
 H.8/9 cm. <b>Kit piedini cromati per contenitori (N°4)</b> <i>Small feet for cabinets (N°4)</i> 4 petits pieds pour armoires	AC125		CR		1	0,010	2,0	64,00
 <b>Talaio estraibile per contenitori Prof.44</b> <i>Pull-out frame for cabinets depth 44</i> Chassis escamotable pour armoires Prof.44	AC130		AL		1	0,041	6,0	141,00
 <b>Appendiabito estraibile per contenitori Prof.44</b> <i>Pull-out coathanger for cabinets depth 44</i> Portemanteau escamotable pour armoires Prof.44	AC135		AL		1	0,002	0,3	22,00
 <b>Specchio per anta alta</b> <i>Mirror for wardrobe high door</i> Miroir pour porte haute garde-robe	AC140		V		1			35,00
 <b>Frigo Lt.39</b> <i>Lt.39 fridge</i> Réfrigérateur Lt.39	AC145				1	0,115	20,0	829,00
 <b>Ripiano spostabile 1 anta</b> <i>Movable shelf 1 door</i> Rayons depacable pour armoires à 1 porte	AC150		AL NR BI GAV	41,4 x 32 SP.2,5	1	0,007	2,5	11,00
	AC150.1			41,4 x 42 SP.2,5	1	0,009	3,3	14,00
 <b>Ripiano spostabile 2 ante</b> <i>Movable shelf 2 doors</i> Rayons depacable pour armoires à 2 portes	AC151		AL NR BI GAV	41,4 x 32 SP.2,5	1	0,014	5,3	22,00
	AC151.1			41,4 x 42 SP.2,5	1	0,018	6,9	29,00

## MOBILI E CONTENITORI

ACCESSORI PER CONTENITORI ECESSOIRES FOR CABINETS ACCESSOIRES POUR ARMOIRES	CODICE CODE CODE		FIN. SCOCCA STRUCTURE FINISHING FIN. STRUCT.	L x P x SP. W x D x SP. L x P x SP.	COLLI PACKS COLIS	VOLUMI VOLUME VOLUME	PESO WEIGHT POIDS	PREZZO PRICE PRIX €
 <p><b>Ripiano spostabile per angolo interno</b> <i>Movable shelf 1 door for internal corner</i> Rayons depacable pour armoires à 1 porte</p>	<b>AC152</b>		<b>AL NR BI GAV</b>	62,4x62,4 SP.2,5 P.34	1	0,020	7,5	<b>64,00</b>
	<b>AC152.1</b>			72,4x72,4 SP.2,5 P.44	1	0,026	10,1	<b>75,00</b>
 <p><b>Ripiano spostabile per angolo esterno</b> <i>Movable shelf 1 door for external corner</i> Rayons depacable pour armoires à 1 porte</p>	<b>AC153</b>		<b>AL NR BI GAV</b>	32,2x32,2 SP.2,5 P.34	1	0,005	2,1	<b>41,00</b>
	<b>AC153.1</b>			42,2x42,2 SP.2,5 P.44	1	0,009	3,5	<b>47,00</b>
 <p><b>Serratura per ante legno</b> <i>Lock for wooden doors</i> Serrure pour portes mélaminé</p>	<b>AC100</b>							<b>13,00</b>
 <p><b>Serratura per ante scorrevoli</b> <i>Lock for wooden sliding doors</i> Serrure pour portes coulissante mélaminé</p>	<b>AC101</b>							<b>20,00</b>
 <p><b>Serratura per cassettiere</b> <i>Lock for drawers</i> Serrure pour tiroirs</p>	<b>AC102</b>							<b>20,00</b>
 <p><b>Serratura per ante vetro con telaio</b> <i>Lock for glass doors with frame</i> Serrure pour portes en verre avec bati</p>	<b>AC103</b>							<b>19,00</b>
 <p><b>Maniglia cromata per ante legno</b> <i>Handle chromed for wooden desk</i> Poignée chromé pour portes mélaminé</p>	<b>AC110</b>	<b>BI CR NR</b>						<b>6,00</b> PER DIFFERENZA FOR DIFFERENCE DE LA DIFFÉRENCE

## MOBILI E CONTENITORI

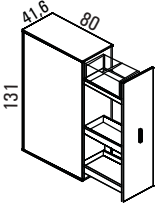
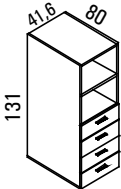
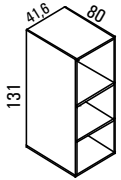
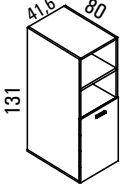
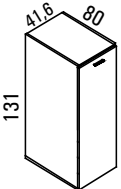
MOBILI MULTIFUNZIONE MULTIFUNCTIONAL CABINETS MEUBLES MULTI-FONCTION	CODICE CODE CODE	FIN. FRONT. FRONTAL FINISHING FIN. PLANS-TIROIRS	FIN. SCOCCA STRUCTURE FINISHING FIN. STRUCT.	L x P x SP. W x D x TH. L x P x EP.	COLLI PACKS COLIS	VOLUMI VOLUME VOLUME	PESO WEIGHT POIDS	PREZZO PRICE PRIX €
 <p><b>Mobile porta-dox/porta cartelle con anta estraibile</b> <i>Cabinet with pull-out door with filing section</i> <i>Meuble avec porte coulissante</i></p>	<b>S0566</b>	NCA RM RSB OL GAV GTO BI	AL NR BI GAV	41,6 x 80 x 135	1	0,480	69,0	<b>648,00</b>
 <p><b>Modulo 4 cassetti + vano a giorno</b> <i>Medium cabinet with drawers</i> <i>Armoire moyenne avec caisson</i></p>	<b>S0571</b>	NCA RM RSB OL GAV GTO BI	AL NR BI GAV	41,6 x 80 x 135	1	0,480	75,0	<b>620,00</b>
 <p><b>Contentitore medio a giorno</b> <i>Medium cabinet</i> <i>Armoire moyenne à jour</i></p>	<b>S0572</b>	NCA RM RSB OL GAV GTO BI	AL NR BI GAV	41,6 x 80 x 135	1	0,480	50,0	<b>280,00</b>
 <p><b>Contentitore medio a giorno+ Anta bassa legno</b> <i>Medium cabinet + 1 low wooden door</i> <i>Armoire moyenne à jou + 1 porte basse mélaminé</i></p>	<b>S0573 DX-SX</b>	NCA RM RSB OL GAV GTO BI	AL NR BI GAV	41,6 x 80 x 135	1	0,480	65,0	<b>342,00</b>
 <p><b>Contentitore medio a giorno+ Anta bassa legno</b> <i>Medium cabinet + 1 low wooden door</i> <i>Armoire moyenne à jou + 1 porte basse mélaminé</i></p>	<b>S0574 DX-SX</b>	NCA RM RSB OL GAV GTO BI	AL NR BI GAV	41,6 x 80 x 135	1	0,480	70,0	<b>370,00</b>

**MOBILI E CONTENITORI**

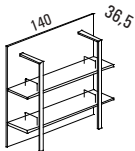
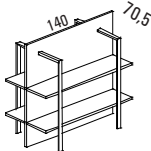
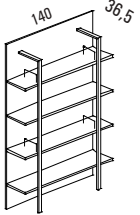
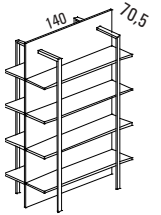
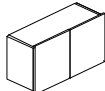
FILING LIBRERIA BOOKCASE FO FILING ARMOIRE	CODICE CODE CODE	FIN. SCHIENALE FINISHING BACK PANEL FINITION RETOUR	FIN. MENSOLA FIN. SHELF FINITION ETAGERE	FIN. DTRUTTURA STRUCTURE FINISHING FIN. STRUCT.	L x P x H. W x D x H. L x P x H.	COLLI PACKS COLIS	VOLUMI VOLUME VOLUME	PESO WEIGHT POIDS	PREZZO PRICE PRIX
									€
 <p><b>H.121</b></p> <p><b>Libreria</b> <i>Bookcase</i> Bibliothèques</p>	<b>S0590</b>	NCA RM RSB OL GAV GTO BI	NCA RM RSB OL GAV GTO BI	AL	140 x 36,5 x 121	3	0,145	45,0	<b>420,00</b>
				CR					<b>620,00</b>
 <p><b>H.121</b></p> <p><b>Libreria doppia</b> <i>Double bookcase</i> Bibliothèques</p>	<b>S0591</b>	NCA RM RSB OL GAV GTO BI	NCA RM RSB OL GAV GTO BI	AL	140 x 70,5 x 121	4	0,215	75,0	<b>756,00</b>
				CR					<b>1.156,00</b>
 <p><b>H.197,2</b></p> <p><b>Libreria</b> <i>Bookcase</i> Bibliothèques</p>	<b>S0592</b>	NCA RM RSB OL GAV GTO BI	NCA RM RSB OL GAV GTO BI	AL	140x36,5x197,2	3	0,265	85,0	<b>774,00</b>
				CR					<b>1.024,00</b>
 <p><b>H.197,2</b></p> <p><b>Libreria doppia</b> <i>Double bookcase</i> Bibliothèques</p>	<b>S0593</b>	NCA RM RSB OL GAV GTO BI	NCA RM RSB OL GAV GTO BI	AL	140x70,5x197,2	5	0,385	145,0	<b>1.393,00</b>
				CR					<b>1.893,00</b>
 <p><b>Contenitore per librerie</b> <i>Cabinet bookcase</i> Bibliothèques à jour</p>	<b>S0594</b>	NCA RM RSB OL GAV GTO BI	AL NR OL GAV		80 x 31,5 x 40	1	0,170	18,0	<b>168,00</b>





# STUDIO OFFICE







CONTENITORI E MOBILI METALLICI  
 METAL CABINETS  
 ARMOIRES METALLIQUES

SERIE LINE SERIE  <b>01</b> <b>PLUS</b>	<b>CONTENITORI ANTE                  BATTENTI E                  CLASSIFICATORI</b>		<b>FINITURE - FINISHES - FINITIONS</b>	
	<i>CABINETS WITH SWING                  DOORS AND FILING</i>		<b>AL (9006)</b>	<b>Alluminio - Aluminium - Aluminum</b>
	<b>ARMOIRES AVEC PORTES                  BATTANTE ET                  CLASSEURS MOBILE</b>		<b>BI (9010)</b>	<b>Bianco - White - Blanc</b>
			<b>GTO (7044)</b>	<b>Grigio tortora - Dove grey - Gris torturelle</b>



SERIE LINE SERIE  <b>02</b>	<b>CONTENITORI ANTE                  BATTENTI E                  SCORREVOLI</b>		<b>FINITURE - FINISHES - FINITIONS</b>	
	<i>CABINETS WITH SWING                  AND SLIDING DOORS</i>		<b>GR (7035)</b>	<b>Grigio - Grey - Gris</b>
	<b>ARMOIRES AVEC PORTES                  BATTANTE ET                  COLISSANTES</b>		<b>BI (9010)</b>	<b>Bianco - White - Blanc</b>

SERIE LINE SERIE  <b>03</b>	<b>CASSETTIERE E                  CLASSIFICATORI SU                  RUOTE</b>		<b>FINITURE - FINISHES - FINITIONS</b>	
	<i>DRAWERS AND FILING</i>		<b>AL (9006)</b>	<b>Alluminio - Aluminium - Aluminum</b>
	<b>CAISSONS ET CLASSEURS</b>		<b>BI (9010)</b>	<b>Bianco - White - Blanc</b>
			<b>NR (9005)</b>	<b>Nero - Black - Noir</b>
			<b>GTO (7044)</b>	<b>Grigio tortora - Dove grey - Gris torturelle</b>





**CONTENITORI E MOBILI METALLICI**  
**METAL CABINETS**  
**ARMOIRES METALLIQUES**

CONTENITORI E CLASSIFICATORI SERIE 01 PLUS CABINETS AND FILING LINE 01 PLUS ARMOIRES ET CLASSEURS SERIE 01 PLUS		CODICE CODE CODE	FINITURA FINISHING FINISSAGE	L x P x H. W x D x H. L x P x H.	COLLI PACKS COLIS	VOLUMI VOLUME VOLUME	PESO WEIGHT POIDS	PREZZO PRICE PRIX €
	H.72	SOM250	AL BI GTO	100 x 45 x 72	1	0,590	55,0	1.405,00
<b>Mobile classificatore con serratura cassetti)</b> <i>Mobile filing with lock (2 drawers)</i> Classeur mobile avec serrure (2 tiroirs)	(2)	SOM250.1		80 x 45 x 72	Non disponibile			
	H.72	SOM251	AL BI GTO	100 x 45 x 72	3	0,130	26,0	790,00
<b>Mobile basso con ante battenti e serratura</b> <i>Low cabinet with swing doors and lock</i> Armoire basse avec portes battante et serrure								
	H.101	SOM252	AL BI GTO	100 x 45 x 101	1	0,650	65,0	1.780,00
<b>Mobile classificatore con serratura cassetti)</b> <i>Mobile filing with lock (3 drawers)</i> Classeur mobile avec serrure (3 tiroirs)	(3)	SOM252.1		80 x 45 x 101	Non disponibile			
	H.101	SOM253	AL BI GTO	100 x 45 x 101	3	0,140	32,0	875,00
<b>Mobile basso con ante battenti e serratura</b> <i>Low cabinet with swing doors and lock</i> Armoire basse avec portes battante et serrure								
	H.133	SOM254	AL BI GTO	100 x 45 x 133	1	0,650	72,0	1.870,00
<b>Mobile classificatore con serratura cassetti)</b> <i>Mobile filing with lock (3 drawers)</i> Classeur mobile avec serrure (3 tiroirs)	(3)	SOM254.1		80 x 45 x 133	Non disponibile			
	H.133	SOM255	AL BI GTO	100 x 45 x 72	4	0,180	41,5	950,00
<b>Mobile medio con ante battenti e serratura</b> <i>Medium cabinet with swing doors and lock</i> Armoire moyenne avec portes battante et serrure								

**CONTENITORI E MOBILI METALLICI**  
**METAL CABINETS**  
**ARMOIRES METALLIQUES**

<b>CONTENITORI E CLASSIFICATORI SERIE 01 PLUS</b> <i>CABINETS AND FILING LINE 01 PLUS</i> <b>ARMOIRES ET CLASSEURS SERIE 01 PLUS</b>	<b>CODICE</b> <i>CODE</i> <b>CODE</b>	<b>FINITURA</b> <i>FINISHING</i> <b>FINISSAGE</b>		<b>L x P x H.</b> <i>W x D x H.</i> <b>L x P x H.</b>	<b>COLLI</b> <i>PACKS</i> <b>COLIS</b>	<b>VOLUMI</b> <i>VOLUME</i> <b>VOLUME</b>	<b>PESO</b> <i>WEIGHT</i> <b>POIDS</b>	<b>PREZZO</b> <i>PRICE</i> <b>PRIV</b> <b>€</b>
 <p><b>H.165</b></p> <p><b>Mobile medio con ante battenti e serratura</b>  <i>Medium cabinet with swing doors and lock</i>  <b>Armoire moyenne avec portes battante et serrure</b></p>	<b>SOM256</b>	<b>AL BI GTO</b>		100 x 45 x 165	4	0,190	53,0	<b>1.060,00</b>
 <p><b>H.200</b></p> <p><b>Mobile alto con ante battenti e serratura</b>  <i>High cabinets with swing doors and lock</i>  <b>Armoire haute avec portes battante et serrure</b></p>	<b>SOM257</b>	<b>AL BI GTO</b>		100 x 45 x 200	4	0,250	62,0	<b>1.200,00</b>



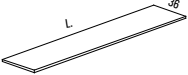
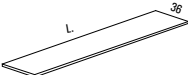
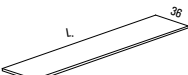

**CONTENITORI E MOBILI METALLICI**  
**METAL CABINETS**  
**ARMOIRES METALLIQUES**

CONTENITORI METALLICI SERIE 02 METAL CABINETS LINE 02 ARMOIRE METALLIQUES SERIE 02		CODICE CODE CODE	FINITURA FINISHING FINISSAGE	FINITURA ANTE DOORS FINISHING FINITIONPORTES	L x P x H. W x D x H. L x P x H.	COLLI PACKS COLIS	VOLUMI VOLUME VOLUME	PESO WEIGHT POIDS	PREZZO PRICE PRIX €
<p><b>H.88</b></p> <p>1 Ripiano 1 Shelf 1 Etagère</p>  <p><b>Mobile basso con ante battenti e serratura</b> Low cabinet with swing doors and lock Armoire basse avec portes battante et serrure</p>	SOM260	GR BI		100 x 45 x 88	5	0,200	34,0	620,00	
<p><b>H.200</b></p> <p>4 Ripiani 4 Shelves 1 Etagères</p>  <p><b>Mobile alto con ante battenti e serratura</b> High cabinet with swing doors and lock Armoire haute avec portes battante et serrure</p>	SOM261	GR BI		100 x 45 x 200	5	0,380	74,0	930,00	
<p><b>H.88</b></p> <p>1 Ripiano 1 Shelf 1 Etagère</p>  <p><b>Mobile basso con ante scorrevoli e serratura</b> Low cabinet with sliding doors and lock Armoire basse avec portes en coulissante et serrure</p>	SOM262	GR BI	GR BI	120 x 45 x 88	5	0,210	40,0	640,00	
								V	
<p><b>H.200</b></p> <p>4 Ripiani 4 Shelves 1 Etagères</p>  <p><b>Mobile alto con ante scorrevoli e serratura</b> High cabinet with sliding doors and lock Armoire haute avec portes en coulissante et serrure</p>	SOM263	GR BI	GR BI	120 x 45 x 200	5	0,400	83,0	960,00	
								V	
<p><b>H.88</b></p> <p>1 Ripiano 1 Shelf 1 Etagère</p>  <p><b>Mobile basso con ante scorrevoli e serratura</b> Low cabinet with sliding doors and lock Armoire basse avec portes en coulissante et serrure</p>	SOM264	GR BI	GR BI	180 x 45 x 88	5	0,870	80,0	850,00	
								V	

**CONTENITORI E MOBILI METALLICI**  
**METAL CABINETS**  
**ARMOIRES METALLIQUES**

TOP CONTENITORI METALLICI SERIE 1-2 TOP FOR METAL CABINETS LINE 1-2 TOP POUR ARMOIRE METALLIQUES SÉRIE 1-2		CODICE CODE CODE	FINITURA FINISHING FINISSAGE	FINITURA ANTE DOORS FINISHING FINITIONPORTES	L x P x H. W x D x H. L x P x H.	COLLI PACKS COLIS	VOLUMI VOLUME VOLUME	PESO WEIGHT POIDS	PREZZO PRICE PRIX €
 <p><b>H.200</b></p> <p>4 Ripiani 4 Shelves 1 Etagères</p> <p><b>Mobile alto con ante scorrevoli e serratura</b> High cabinet with sliding doors and lock Armoire haute avec portes en coulissante et serrure</p>	<b>SOM265</b>	<b>GR BI</b>	<b>GR BI</b>	180 x 45 x 200	5	0,620	118,0	<b>1.315,00</b>	
			<b>V</b>					<b>1.615,00</b>	
 <p><b>Top armadi L.100</b> Top for cabinets W.100 Top pour armoire L.100</p>	<b>SOM270</b>	<b>GR BI</b>		100 x 45 x 1,8	1	0,013	3,5	<b>130,00</b>	
 <p><b>Top armadi L.120</b> Top for cabinets W.120 Top pour armoire L.120</p>	<b>SOM271</b>	<b>GR BI</b>		120 x 45 x 1,8	1	0,023	4,0	<b>140,00</b>	
 <p><b>Top armadi L.180</b> Top for cabinets W.180 Top pour armoire L.180</p>	<b>SOM272</b>	<b>GR BI</b>		120 x 45 x 1,8	1	0,035	6,5	<b>160,00</b>	

**CONTENITORI E MOBILI METALLICI**  
**METAL CABINETS**  
**ARMOIRES METALLIQUES**

<b>CASSETTIERE E CLASSIFICATORI SU RUOTE</b> <i>METAL MOBILE DRAWER AND FILING</i> <b>CAISSONS ET CLASSEURS SUR ROULETTES</b>	<b>CODICE</b> <i>CODE</i> <b>CODE</b>	<b>FINITURA</b> <i>FINISHING</i> <b>FINISSAGE</b>		<b>L x P x H.</b> <i>W x D x H.</i> <b>L x P x H.</b>	<b>COLLI</b> <i>PACKS</i> <b>COLIS</b>	<b>VOLUMI</b> <i>VOLUME</i> <b>VOLUME</b>	<b>PESO</b> <i>WEIGHT</i> <b>POIDS</b>	<b>PREZZO</b> <i>PRICE</i> <b>PRIX</b> <b>€</b>
 <p><b>Cassettiera metallica su ruote con serratura simultanea</b>  <i>Metal mobile drawer pedestal on castors with lock</i>  <b>Caisson mobile metallique avec serrure sur roulettes</b></p>	<b>S0280</b>	<b>AL BI NR GTO</b>		42 x 53,3 x 55,5	1	0,160	20,0	<b>278,00</b>
 <p><b>Classificatore metallico su ruote con serratura simultanea</b>  <i>Metal mobile filing pedestal on castors with lock</i>  <b>Classeur mobile metallique avec serrure sur roulette</b></p>	<b>SOM281</b>	<b>AL BI NR GTO</b>		42 x 53,3 x 55,5	1	0,160	20,0	<b>288,00</b>
 <p><b>Classificatore metallico su ruote con serratura simultanea + cassetto</b>  <i>Metallic service cabinet on castors with simultaneous lock and drawer</i></p>	<b>SOM282</b>	<b>AL BI NR GTO</b>		42 x 53,3 x 55,5	1	0,160	20,0	<b>355,00</b>
 <p><b>H.101,6</b></p> <p><b>Classificatore metallico con serratura (3 cassetti)</b>  <i>Metal mobile filing with lock (4 drawers)</i>  <b>Classeur mobile en metallique avec serrure (4 tiroirs)</b></p>	<b>SOM290</b>	<b>GR</b>		47 x 62,1 x 101,6	1	0,320	45,0	<b>615,00</b>
 <p><b>H.132,1</b></p> <p><b>Classificatore metallico (4 cassetti)</b>  <i>Metal mobile filing with lock (4 drawers)</i>  <b>Classeur mobile en metallique avec serrure (4 tiroirs)</b></p>	<b>SOM291</b>	<b>GR</b>		47 x 62,1 x 132,1	1	0,390	55,0	<b>655,00</b>



# STUDIO OFFICE

## CONDIZIONI GENERALI DI VENDITA

- 1) La proposta d'ordine è subordinata all'accettazione della ditta produttrice e deve essere confermata per iscritto, essa deve essere compilata citando modello, codice, quantità e tutte le altre notizie necessarie per accelerare l'evasione dello stesso.
- 2) I termini di consegna sono di 50 giorni, la mancata consegna a causa di forza maggiore o inadempimento dei termini di pagamento e qualsiasi altro motivo non danno luogo ad alcuna forma di indennizzo o risarcimento.
- 3) La merce viaggia a rischio e pericolo del committente anche se spedita in porto franco. Al committente spetta l'azione di rivalsa nei confronti del vettore per danni dovuti al trasporto, tali danni dovranno essere evidenziati sulle bolle di consegna rese firmate al trasportatore.
- 4) Qualsiasi altro reclamo riguardante la merce dovrà essere inoltrato per iscritto entro 8 giorni dal ricevimento della suddetta.
- 5) Non si accettano resi senza autorizzazione da parte della ditta venditrice.
- 6) Le vendite si intendono fatte sotto condizione sospensiva (art. 1449 cc) rimanendo la merce di proprietà della ditta venditrice sino a che non sia interamente pagata.
- 7) I pagamenti sono validi e liberatori solo se effettuati presso la sede della ditta venditrice nei termini e nei modi pattuiti.  
Nel caso di ritardo di pagamento decorreranno gli interessi di mora al tasso bancario in vigore.
- 8) I prezzi non contemplano l'I.V.A. e sono modificabili in qualsiasi momento ad insindacabile giudizio della società.
- 9) Per ordini di importo netto superiore a Euro 800,00 la spedizione della merce è in porto franco. Per ordini di importo inferiore verrà applicato un addebito in fattura pari all'8% del totale della merce a titolo di contributo spese trasporto, con un minimo di Euro 26,00.
- 10) Il presente listino annulla e sostituisce tutti i precedenti.
- 11) Per qualsiasi controversia, l'esclusivo foro competente è quello di Teramo.
- 12) Le condizioni sopra indicate hanno validità solo per l'Italia.
- 13) La Tecnoarredo srl, si riserva il diritto di apportare modifiche tecniche ed estetiche alla propria produzione, anche senza preavviso, al fine di migliorare i propri prodotti.

## GENERAL SALES CONDITIONS

### Pricing and Ordering Information

All orders and prices are subject to acceptance by the company. Prices are subject to changes without written notice. Orders will be passed to production only after customer pro forma written formal acceptance.

Out of standard products are subject to additional cost. Prices for changes are quoted upon request. All orders will be accepted with the understanding that PRICES IN EFFECT AS DATE OF ORDER ACCEPTANCE WILL PREVAIL. Unshipped orders are subject to price increase which will be calculated on the amount of time spent in the warehouse. The manufacturer reserves the right to make changes in material, colour, design or price without notice or discontinue any of the products listed in this catalogue without notice.

### Payment Terms

Goods remain of the property of the manufacturer until total payment. Method of payment is according to the agreement/contract accepted by the manufacturer and buyer.

### Shipping Instructions

Delivery is ex works. Prices do not include transport and handling charges.

Title of goods is transferred to the customer when shipment is consigned to the carrier. Extra charges will apply if special packaging is required.

**Damaged, Lost Or Short Shipments:** Tecnoarredo packaging complies with the requirements of consolidated freight classifications. All goods must be checked by customer immediately upon receipt and inspected for eventual damages or shortages. If a problem with shipment is discovered, goods must be kept for inspection by the carrier.

**Complaints** concerning manufacturing defects will have to be stated within 8 (eight) calendar days within goods receipt. They will have to be reported by official statement describing defects characteristics. Moreover complaint will have to be provided with picture report. Replacing goods will be shipped and **Caution:** If a shipment is received with damaged merchandise, or a shortage, and clear receipt is given to the delivering carrier, you are responsible to file claim with the carrier within 15 calendar days. Tecnoarredo s.r.l. will not accept return of damaged merchandise

### Assembly and Installation of Products

Assembly and installation of products is at customer charge. Tecnoarredo srl is entitled to change product technical and aesthetic characteristics to improve company production standards without giving communication in advance.

**Forum:** in case of any legal dispute, Teramo is the competent Forum.

## GENERAL SALES CONDITIONS

**Commandes:** toutes les commandes sont subordonnées à l'acceptation du siège. Elles doivent rapporter la gamme, l'article et quantité désirés et doivent être toujours confirmées par écrit.

**Livraison:** 7 semaines à partir du jour de la confirmation par écrit de la commande.

**Prix :** prix au public hors-taxe départ usine.

**Transport:** frais de transport et assurance à la charge de l'acheteur.

**Paiement:** la marchandise reste de propriété du fabricant jusqu'au moment du paiement total. Les paiements peuvent être effectués de la façon suivante: A) au comptant à la livraison - B) cheque avalisé par la banque - C) lettre de crédit - D) traite à moyen terme escompté sans recours avalisé par la banque - E) engagement bancaire irrévocable de transfert.

**Emballage:** cartons sur palettes filmées à ne pas défaire.

### Réclamation pour les dommages

La marchandise voyage aux risques et périls du client. Les défauts des emballage doivent être contestés à l'arrivée de la marchandise. Réserves éventuelles seront présentées immédiatement au transporteur qui est responsable de la marchandise à partir de la livraison jusqu'à son déchargement.

### Modification des produits

Tecnoarredo s.r.l. se réserve le droit d'apporter des modifications techniques ou esthétiques sans préavis à ses produits à fin de les perfectionner. Le client ne peut pas refuser la marchandise modifiée ou demander des modèles non modifiés.

**Tribunal competent:** en cas de litiges, on reconnaît exclusivement la compétence du Tribunal de Teramo (Italie).



# STUDIO OFFICE

## TERMINI DI GARANZIA

Tutti i mobili Tecnoarredo srl sono garantiti all'acquirente originale al momento dell'acquisto per un periodo di 2 ( due ) anni di servizio a turno unico dalla data di consegna. La Tecnoarredo srl garantisce all'acquirente originale che il mobile e tutte le sue parti e componenti nel momento in cui vengono spediti sono senza difetti nel materiale e nella lavorazione poiché il controllo qualità avviene sul 100% della merce prodotta. Per "difetto di produzione" si intende qualsiasi imperfezione che non rientra nello standard di prodotto e/o che ne compromette l'utilizzo del prodotto stesso.

La garanzia della Tecnoarredo srl è espressamente limitata alla sostituzione di parti e componenti di mobili. La garanzia sarà ritenuta valida solo se l'acquirente provvederà a rilevare i difetti di produzione entro e non oltre 15 giorni dalla data di ricezione della merce. I reclami non saranno presi in considerazione se non accompagnati da un elenco dettagliato dei difetti e da fotografie che ne comprovino il danno. I costi per la spedizione della merce difettosa sono sempre a carico dell'acquirente.

La garanzia è valida per normali condizioni d'uso. I mobili Tecnoarredo non possono essere utilizzati all'aperto, non possono essere messi a contatto con fonti di calore ed umidità.

Le parti in vetro devono essere maneggiate, movimentate ed installate con cautela; gli sportelli ed i cassetti devono essere riportati allo stato di chiusura subito dopo l'uso.

La garanzia non copre:

- 1) difetti causati da un assemblaggio o smontaggio improprio;
- 2) difetti che emergono dopo l'acquisto in seguito a modifiche apportate al prodotto o sue parti, danni intenzionali, incidenti, uso errato, abuso, negligenza, esposizione agli elementi;
- 3) difetti causati dal trasporto;
- 4) l'uniformità del colore, la venatura o la tessitura dei materiali di copertura, eccezion fatta per gli standard commercialmente accettabili.

Il Rivenditore provvederà a predisporre clausole di garanzia da fornire all'acquirente finale.

Egli potrà ampliare le garanzie offerte dal Fabbricante, ma tutte le garanzie aggiuntive saranno a carico e sotto la responsabilità del Rivenditore stesso.

Nel certificato di garanzia il Rivenditore dovrà prevedere, fra l'altro, le modalità mediante le quali l'utente finale dovrà attivare l'intervento in garanzia. Il Rivenditore effettuerà l'intervento in garanzia presso l'utente finale, anche se a carico della Tecnoarredo, che provvederà a fornire le parti da sostituire (se i difetti sono coperti dalla garanzia di Tecnoarredo srl).

Il certificato di garanzia predisposto dal Rivenditore per gli utenti finali impegna la Tecnoarredo nei limiti del prezzo di acquisto corrisposto dal Rivenditore

Il rispetto delle leggi vigenti nel Territorio, per quanto concerne la compilazione del certificato di garanzia, sono a cura e carico del Rivenditore.

## WARRANTY TERMS

The original buyer of Tecnoarredo srl furniture units is covered by a 2 (two) year "single-shift service" warranty starting from date of goods delivery.

Tecnoarredo srl guarantees to the original buyer that the furniture unit and all its parts and components are void of material and manufacturing faults since internal quality standards check and test products 100% before delivery. The word "manufacturing fault" in the warranty refers to any product that doesn't match with product standard and/or any imperfection affecting product use.

Tecnoarredo srl warranty is expressly restricted to replacement of furniture parts and components. Warranty will be applied only if eventual damages are being reported within 15 days from receipt of goods. Complaints will not be taken into consideration unless they will be specified by a technical description of the faults and by pictures showing the issue.

Any delivery cost for items replacement are on charge of the Buyer.

Warranty covers normal conditions of use. Tecnoarredo srl furniture cannot be used out of doors; in contact with heat sources and damp. Glass parts must be handled, moved and installed with special care; doors and drawers must always be closed immediately after use.

Warranty does not cover:

- 1) faults caused by incorrect assembly or dismantling;
- 2) faults and/or damages occurring after purchase caused by changes made to product or its parts, intentional damage, accidents, wrong use, abuse, negligence, exposure to elements;
- 3) faults and/or damages caused by transport;
- 4) colour uniformity, flame, grains or patterns of facing material, exception made for commercially acceptable standards.

The Buyer will provide warranty clauses to be given to the end buyer. The Buyer is entitled to extend the warranties offered by the Manufacturer, but all additional warranties shall be at charge and under responsibility of the Buyer. The Buyer must show in the warranty certificate the procedures by means of which the end user must request jobs under warranty. The Buyer shall carry out jobs under warranty on the premises of the end user, even if provoked by Tecnoarredo, which shall replace the parts to the Buyer.

The warranty certificate prepared by the Buyer for the end users shall commit Tecnoarredo srl within the limits of the price paid by the Buyer.

The Buyer shall undertake and be responsible for observing the laws applicable in the Area as regards the drawing up of the warranty certificate.

## GARANTIE

Tous les meubles Tecnoarredo sont garantis à l'acheteur original au moment de l'achat pour une période de 2 (deux) ans à compter de la date de livraison.

La Tecnoarredo Ltd garantit à l'acheteur original que le mobilier et toutes ses pièces et composants sont exempts de défauts de matériaux et de fabrication quand ils sont livrés, au moment que le contrôle qualité se fait sur 100% des marchandises produites. Pour « défaut de fabrication » s'entend toute imperfection qui n'est pas dans le produit standard et / ou affecte l'utilisation du produit même.

La garantie Tecnoarredo Ltd est expressément limitée au remplacement des pièces et des composants de meubles. La garantie est valable seulement si l'acheteur sera à détecter les défauts de fabrication au plus tard 15 jours à partir de la date de réception de la marchandise. Aucune réclamation ne sera considérée s'elle ne sera pas accompagnée d'une liste détaillée des défauts et des photographies qui prouvent les dommages. Les frais d'expédition de la marchandise défectueuse sont toujours payés par l'acheteur. La garantie est valable pour les conditions normales d'utilisation. Les meubles Tecnoarredo ne peuvent pas être utilisés à l'extérieur, ne peuvent pas être mis en contact avec des sources de chaleur et d'humidité. Les parties en verre doivent être manipulés, déplacés et installés avec prudence, les portes et les tiroirs doivent être fermés immédiatement après l'usage. La garantie ne comprend pas:

- 1) les défauts causés par un mauvais montage ou démontage;
- 2) les défauts qui surviennent après l'achat à la suite de modifications apportées au produit ou à ses parties, dommages intentionnels, accident, mauvaise utilisation, abus, négligence, l'exposition aux éléments;
- 3) les défauts causés par le transport;
- 4) l'uniformité de la couleur, le grain ou la texture des matériaux de toiture, à l'exception des normes commercialement acceptables.

L'Acheteur préparera termes de sécurité que doivent être fournis à l'acheteur final.

Il va étendre les garanties offertes par le fabricant, mais toutes les garanties supplémentaires seront en charge et sous la responsabilité de l'acheteur. Dans la garantie l'Acheteur doit fournir, entre autres choses, la manière dont l'utilisateur final pourra activer la garantie. L'acheteur fera le travail de garantie à l'utilisateur final, même si dépendant par la négligence de Tecnoarredo, qui fournira les pièces à remplacer (si les défauts sont couverts par la garantie de Tecnoarredo Ltd).

Le certificat de garantie établi par l'Acheteur pour les utilisateurs finaux commis Tecnoarredo dans les limites du prix d'achat payé par l'acheteur.

La conformité avec les lois du Territoire, en ce qui concerne la compilation de la garantie, sont en charge de l'Acheteur.