

Fly desk 03/2016

Fly bench 03/2016

Informazioni

Information
Informations

- 3 **Caratteristiche tecniche**
5 Technical details
7 Caractéristiques techniques
- 9 **Peso, volume, colli**
Weight, volume, packages
Poids, volume, colis
- 15 **Abbinamenti colore e come ordinare**
Colour matching and how to order
Association coloris et comment passer la commande
- 22 **Composizioni**
Compositions
Compositions
- 28 **Scrivanie in vetro**
Glass desks
Bureaux avec plateau en verre
- 33 **Scrivanie in nobilitato**
Melamine desks
Bureaux avec plateau mélaminé
- 41 **Elementi per composizioni con struttura cavalletto**
Elements for composition with trestle structure
Éléments pour compositions avec structure piètement
- 64 **Tavoli riunione**
Meeting tables
Tables de réunion
- 66 **Zona di attesa**
Waiting area
Zone d'accueil
- 67 **Cassettiere su ruote**
Drawer units on wheels
Caissons à roulettes
- 68 **Cassettiere portanti**
Bearing drawer units
Caissons porteurs
- 69 **Serventi H63**
H63 pedestals
Dessertes H63
- 71 **Serventi H43**
H43 Pedestals
Dessertes H43
- 73 **Pianetto sopraelevato**
Raised shelf
Tablette surélevée
- 75 **Screen**
Screens
Ecran
- 81 **Modesty panel**
Modesty panel
Voile de fond
- 82 **Accessori per scrivania**
Desk accessories
Accessoires de bureau
- 84 **Esplicativo per elettrificazione**
Cable management
Détails du passage de câbles
- 85 **Accessori per elettrificazione**
Cable management accessories
Accessoires pour le passage de câbles
- 87 **Contenitori strutturali**
Structural cabinets
Armoires structurelles



Caratteristiche fisico-meccaniche dei pannelli in nobilitato melaminico

Emissione di formaldeide: E1

Spessori: cm 1.2 – 1.8. – 2.8

Densità: kg 660 (+ -3%) mc (DIN 68763/81)

Piani in nobilitato

Nobilitato melaminico di qualità E1.

Spessore: cm 1.8 – 2.8 con bordo ABS 20/10 stondato antiurto su tutti i lati del piano lavoro.

Colori: **G** Grigio chiaro - **W** Bianco – **RC** Rovere chiaro - **NA** Noce Ambra - **WE** Wengè

ATTENZIONE: Le finiture Bianco e Wengè non rispettano il Decreto Legislativo 81/08 (Italia), e sono disponibili su specifica richiesta del cliente, con cui questi (A) dichiarano formalmente di essere a conoscenza della difformità e delle violazioni di legge e (B) manleva la Babini spa da ogni responsabilità e/o conseguenza risarcitoria che possa derivare, ad ogni titolo, dall'utilizzazione di tali finiture, e da chiunque tali richieste possano pervenire.

Piani in vetro

In vetro temprato spessore cm 1.2.

Colori: **WV** Bianco extrachiaro – **KV** Nero

Struttura metallo gamba Cavalletto

FLY01: Tubolare di acciaio a sezione quadrata 4X4 spessore 20/10 piegato e saldato.

Piedi livellabili in acciaio con copri piede in ABS

FLY02: tubolari di acciaio a sezione rotonda Ø60 spessore 15/10, conificati e curvati, collegati tra loro tramite saldatura con tubolare di acciaio a sezione quadrata 4x40 spessore 20/10.

Piedi livellabili in acciaio con copri piede in ABS

Colori: **W** Bianco RAL9003 – **Y** Alluminio Lucido - **EQ** Ecocromo

Struttura in nobilitato

Nobilitato melaminico di qualità E1.

Spessore: cm 2.8 con bordo ABS 20/10 stondato antiurto su tutti i lati.

Colori: **G** Grigio chiaro - **W** Bianco – **RC** Rovere chiaro - **NA** Noce Ambra - **WE** Wengè

FLY01-FLY02: traversa di collegamento gambe in tubolare di acciaio a sezione quadrata 4x4 spessore 15/10.

Colori: **Y** Alluminio Lucido (per tutte le versioni).

Struttura metallo gamba Puntiforme

FLY02: tubolare di acciaio a sezione rotonda Ø60 spessore 15/10, conificato e curvato, saldato su piastra

in acciaio spessore 50/10.

Piedi livellabili in acciaio con copri piede in ABS

Traversa antiflessione in tubolare di acciaio a sezione rettangolare 4x2 spessore 15/10.

Colori: **W** Bianco RAL9003 – **Y** Alluminio Lucido - **EQ** Ecocromo

Screen su barra accessori

Nobilitato

Nobilitato melaminico di qualità E1.

Spessore cm 1.2 con bordo ABS 20/10 stondato antiurto su tutti i lati del piano lavoro.

Colori: **G** Grigio chiaro - **W** Bianco – **RC** Rovere chiaro - **NA** Noce Ambra - **WE** Wengè

Vetro

In vetro temprato spessore cm 1.2.

Colori: **SV** Satinato

Barra per screen

Profilo in estruso di alluminio a sezione rettangolare 6x4, con profilo interno di tenuta in materiale termoplastico.

Dotata di piastre in acciaio per il fissaggio alla struttura metallica delle scrivanie.

Colori: **W** Bianco RAL9003 – **Y** Alluminio Lucido

Screen con telaio di alluminio perimetrale

Nobilitato

Nobilitato melaminico di qualità E1.

Spessore cm 2.8 rifinito perimetralmente con profilo estruso di alluminio. Testate in pressofusione di alluminio.

Colori: **G** Grigio chiaro - **W** Bianco – **RC** Rovere chiaro - **NA** Noce Ambra - **WE** Wengè

Tessuto

Supporto in truciolare di qualità E1.

Spessore cm 2.5 rivestito in tessuto Madrid (100% polipropilene ignifugo) e tessuto Mirage (100% poliestere ignifugo). Rifinito perimetralmente con profilo estruso di alluminio. Testate in pressofusione di alluminio.

Colori: **DN** Madrid Nero - **DG** Madrid Grigio chiaro - **DS** Madrid Grigio scuro - **DR** Madrid Rosso - **DB** Madrid blu - **MN** Mirage Nero - **MG** Mirage Grigio - **MR** Mirage Rosso - **MB** Mirage Blu - **MT** Mirage Tortora - **MP** Mirage Panna – **MA** Mirage Arancione – **MX** Mirage Bordeaux – **MV** Mirage Verde Prato

Telaio perimetrale

Profilo in estruso di alluminio con funzione di aggancio accessori. Testate in pressofusione di alluminio.

Dotato di piastre in acciaio per il fissaggio alla struttura metallica delle scrivanie.

Colori: **W** Bianco RAL9003 –**Y** Alluminio Lucido

Screen fonoassorbenti

Le superfici del pannello sono rivestite in tessuto di poliestere Trevira CS® solidamente applicato all'imbottitura interna con la quale forma un corpo unico.

Possano essere applicati sia alla barra accessori che ai pianetti sopraelevati.

Colori: **GT** Grigio argento - **KT** Nero - **RT** Rosso - **DT** Blu - **BT** Beige

Modesty panel

Nobilitato melaminico di qualità E1.

Spessore cm 1.8 con bordo ABS su tutti i lati.

Dotati di piastre in acciaio per il fissaggio alla struttura metallica delle scrivanie.

Colori: **G** Grigio chiaro - **W** Bianco - **RC** Rovere chiaro - **NA** Noce Ambra - **WE** Wengè

Pianetto sopraelevato

Nobilitato melaminico di qualità E1.

Spessore cm 1.8.

Colori: **G** Grigio chiaro - **W** Bianco – **RC** Rovere chiaro - **NA** Noce Ambra - **WE** Wengè

Staffe strutturali in plastica pigmentata rinforzata con fibra di vetro.

Colori: **W** Bianco RAL9003 -**Y** Alluminio Lucido

Cassettiere su ruote, cassettiere portanti, serventi

Struttura

Nobilitato melaminico di qualità E1.

Spessore cm 1.8 – 2.8

Dotata di 4 ruote in plastica ed acciaio ad alta durata (cassettiera su ruote con schedario complete di 5° ruota) o di piedini di livellamento in plastica ed acciaio (cassettiere portanti – serventi).

Colori: **G** Grigio chiaro - **W** Bianco – **RC** Rovere chiaro - **NA** Noce Ambra - **WE** Wengè - **Z** Alluminio goffrato

Parti frontali

Nobilitato melaminico di qualità E1.

Spessore cm 1.8 con bordo ABS su tutti i lati.

Frontali cassette dotati di serratura con chiusura simultanea.

Cassette interni in metallo completi di guide ad estrazione semplice (ad estrazione totale per cassetto schedario) e sistema antiribaltamento.

Ante dotate di serratura e cerniere con apertura 110°

Colori: **G** Grigio chiaro - **W** Bianco – **RC** Rovere chiaro - **NA** Noce Ambra - **WE** Wengè - **Z** Alluminio goffrato

Maniglie

Plastica: in ABS stampato in finitura Alluminio RAL9006

Metallo: in alluminio pressofuso con finitura Cromato.

Physical-mechanical characteristics of the melamine panels

Formaldehyde emission: E1

Thickness: cm 1.2 – 1.8. – 2.8

Density: kg 660 (+ -3%) m3 (DIN 68763/81)

Melamine worktops

E1 quality melamine.

Thickness: cm 1.8 – 2.8 with ABS 20/10 rounded, impact-resistant edges on all sides of the working surface.

Colours: **G** Light grey - **W** White – **RC** Light oak - **NA** Ambra walnut - **WE** Wengé

WARNING: The White and Wengé finishes do not comply with Legislative Decree 81/08 (Italy) and are available at the customer's specific request, with which the latter (A) formally declare that they are aware of the deformity and the violation of the law and (B) they indemnify Babini spa from any liability and/or consequence of reimbursement of any sort which may stem from the use of these finishes, no matter from whom these requests may arrive.

Glass worktop

In 1.2 cm tempered glass.

Colours: **WV** Extra clear white – **KV** Black

Metal structure trestle leg

FLY01: Square 4x4 sections of tubular steel, 20/10 thick, bent and welded.

Steel feet can be levelled with ABS foot cover.

FLY02: Ø60 round sections of tubular steel, 15/10 thickness, tapered and curved, welded to one another with 4x40 square sections of tubular steel, 20/10 thickness.

Steel feet can be levelled with ABS foot cover.

Colours: **W** RAL9003 White – **Y** Glossy aluminium - **EQ** Eco-chrome

Melamine structure

E1 quality melamine.

Thickness: cm 2.8 with ABS 20/10 rounded, impact-resistant edges on all sides.

Colours: **G** Light grey - **W** White – **RC** Light oak - **NA** Ambra walnut - **WE** Wengé

FLY01-FLY02: legs connection crosspiece in 4x4 square sections of tubular steel, 15/10 thick.

Colours: **Y** Bright Aluminium (for all versions)

Metal structure punctiform leg

FLY02: Ø60 round sections of tubular steel, 15/10 thickness, tapered and curved, welded to 50/10 thick

steel plate.

Steel feet can be levelled with ABS foot cover.

Bend-resistant crosspiece in 4x4 square sections of tubular steel, 15/10 thick.

Colours: **W** RAL9003 White – **Y** Glossy aluminium - **EQ** Eco-chrome

Screen on accessory bar

Melamine

E1 quality melamine.

Thickness: cm 1.2 with ABS 20/10 rounded, impact-resistant edges on all sides of the working surface.

Colours: **G** Light grey - **W** White – **RC** Light oak - **NA** Ambra walnut - **WE** Wengé

Glass

In 1.2 cm tempered glass.

Colours: **SV** Frosted

Bar for screen

Profile in 6x4 rectangular section of extruded aluminium with internal seal profile in thermoplastic material.

Equipped with steel plates for fitting to the metallic structure of the desks.

Colours: **W** RAL9003 White – **Y** Glossy aluminium

Screen with aluminium frame border

Melamine

E1 quality melamine.

2.8 cm thick treated at the border with extruded aluminium profile. Head in pressure die-cast aluminium.

Colours: **G** Light grey - **W** White – **RC** Light oak - **NA** Ambra walnut - **WE** Wengé

Fabric

E1 quality particleboard.

2.5 cm thick in Madrid fabric (100% fire-resistant polypropylene) and Mirage fabric (100% fire-resistant polyester). Treated at the border with extruded aluminium profile. Head in pressure die-cast aluminium.

Colours: **DN** Madrid Black - **DG** Madrid Light grey - **DS** Madrid Dark grey - **DR** Madrid Red - **DB** Madrid Blue - **MN** Mirage Black - **MG** Mirage Grey - **MR** Mirage Red - **MB** Mirage Blue - **MT** Mirage Dove grey - **MP** Mirage Cream - **MA** Mirage Orange - **MX** Mirage Bordeaux - **MV** Mirage Green

Border frame

Extruded aluminium profile with accessory hook

function. Head in pressure die-cast aluminium.

Equipped with steel plates for fitting to the metallic structure of the desks.

Colours: **W** RAL9003 White – **Y** Glossy aluminium

Soundproof screen

Screen surfaces are covered by polyester Trevica CS[®] fabric, applied on internal upholstery creating a single element.

They can be applied on aluminium bar or above the raised shelf.

Colours: **GT** Silver grey -**KT** Black – **RT** Red -**DT** Blue -
BT Beige

Modesty panel

E1 quality melamine.

Thickness: cm 1.8 with ABS edges on all sides.

Equipped with steel plates for fitting to the metallic structure of the desks

Colours: **G** Light grey - **W** White – **RC** Light oak - **NA** Ambra walnut - **WE** Wengé

Raised shelf

E1 quality melamine.

1.8 cm thick.

Colours: **G** Light grey - **W** White – **RC** Light oak - **NA** Ambra walnut - **WE** Wengé

Structural brackets in fibreglass reinforced pigmented plastic.

Colours: **W** RAL9003 White – **Y** Glossy aluminium

Drawer unit on wheels, bearing, pedestal

Structure

E1 quality melamine.

Thickness: cm 1.8 – 2.8.

Equipped with 4 long-lasting plastic and steel wheels (drawer unit on wheels with file drawer complete with 5 wheels) or plastic and steel feet which can be levelled (bearing drawer unit - pedestal).

Colours: **G** Light grey - **W** White – **RC** Light oak - **NA** Ambra walnut - **WE** Wengé - **Z** Embossed aluminium

Front parts

E1 quality melamine.

Thickness: cm 1.8 with ABS edges on all sides.

Drawer fronts equipped with simultaneous closing lock.

Internal drawers in metal complete with simple extraction guides (complete extraction for file drawer) and anti-tipping system.

Door equipped with lock and hinges with 110° opening

Colours: **G** Light grey - **W** White – **RC** Light oak - **NA** Ambra walnut - **WE** Wengé - **Z** Embossed aluminium

Handles

Plastic: in moulded ABS in RAL9006 Aluminium finish

Metal: in die-cast aluminium with Chromium finish

Propriétés physiques et mécaniques des panneaux en mélamine

Émission de formaldéhyde: E1

Épaisseur: 1,2 - 1,8. - 2,8

Densité: 660 kg (+ -3%) m3 (DIN 68763/81)

Plateaux mélaminés

Mélamine de qualité E1.

Épaisseur: 1,8 cm - 2,8 avec chant en ABS 20/10 arrondi anti-choc sur tous les côtés du plan de travail.

Couleurs: **G** Gris clair - **W** Blanc - **RC** Chêne clair - **NA** Noyer Ambra - **WE** Wengé

MISE EN GARDE: Les finitions Blanc et Wengé ne respectent pas le décret législatif 81/08 (Italie), et sont disponibles sur demande spécifique de la part du client, qui doit (A) déclarer formellement qu'il est courant des divergences et des violations du droit et (B) soulever la société Babini spa de toute responsabilité et/ou de toute instance de dédommagement pouvant survenir, à quelque titre que ce soit, suite à l'utilisation de ces finitions et ce, indépendamment de la personne qui l'a avancée.

Plateaux en verre

En verre trempé h.1,2 cm.

Couleurs: **WV** Blanc extra clair - **KV** Noir

Structure en métal piètement

FLY01: Tube d'acier à section carrée 4x4 épaisseur 20/10 plié et soudé.

Vérins de mise à niveau en acier et couvercle en ABS

FLY02: tubes d'acier à section ronde Ø60 épaisseur

15/10, effilés et courbés, reliés entre eux par un tube en

acier soudé, à section carrée 4x40 épaisseur 20/10

Vérins de mise à niveau en acier et couvercle en ABS

Couleurs: **W** Blanc RAL9003 - **Y** Aluminium brillant - **EQ** Eco Chrome

Structure mélaminée

Mélamine de qualité E1.

Épaisseur: 2,8 cm avec chant en ABS 20/10 arrondi antichoc sur tous les côtés.

Couleurs: **G** Gris clair - **W** Blanc - **RC** Chêne clair - **NA** Noyer Ambra - **WE** Wengé

FLY01-FLY02: traverse de raccordement en tube d'acier à section carrée 4x4 épaisseur 15/10.

Couleur: **Y** Aluminium brillant (pour toutes les versions)

Structure en métal piètement effilé

FLY02: tube en acier, de section ronde Ø60 épaisseur 15/10, effilé et courbé, soudé sur tôle d'acier, épaisseur 50/10.

Vérins de mise à niveau en acier et couvercle en ABS
Traverse anti-flexion en tubulaire d'acier à section rectangulaire 4x2, épaisseur 15/10.

Couleurs: **W** Blanc RAL9003 - **Y** Aluminium brillant - **EQ** Eco Chrome

Écran sur barre d'accessoires

Mélamine

Mélamine de qualité E1.

Épaisseur: 1,2 cm avec chant arrondi anti-choc en ABS 20/10 sur tous les côtés du plan de travail.

Couleurs: **G** Gris clair **W** Blanc - **RC** Chêne clair - **NA** Noyer Ambra - **WE** Wengé

Verre

En verre trempé h.1,2 cm.

Couleurs: **SV** Satiné

Barre pour écran

Profil en aluminium extrudé à section rectangulaire 6x4, avec profil interne du joint en matériau thermoplastique. Équipé de plaques d'acier pour la fixation à la structure métallique des bureaux.

Couleurs: **W** Blanc RAL9003 - **Y** Aluminium brillant

Écran avec cadre de pourtour en aluminium

Mélamine

Mélamine de qualité E1.

Épaisseur 2,8 cm, avec profilé en aluminium extrudé sur le pourtour. Embouts en aluminium moulé sous pression.

Couleurs: **G** Gris clair **W** Blanc - **RC** Chêne clair - **NA** Noyer Ambra - **WE** Wengé

Tissu

Panneau de particules, qualité E1.

Épaisseur 2,5 cm, recouvert de tissu Madrid (100% polypropylène ignifuge) et tissu Mirage (100% polyester ignifuge). Profilé en aluminium extrudé sur le pourtour. Embouts en aluminium moulé sous pression.

Couleurs: **DN** Madrid Noir - **DG** Madrid Gris clair - **DS** Madrid Gris foncé - **DR** Madrid Rouge - **DB** Madrid Bleu - **MN** Mirage Noir - **MG** Mirage Gris - **MR** Mirage Rouge - **MB** Mirage Bleu - **MT** Mirage Gris tourterelle - **MP** Mirage Crème - **MA** Mirage Orange - **MX** Mirage Bordeaux - **MV** Mirage Vert

Cadre de pourtour

Profilé en aluminium extrudé - fonction fixation d'accessoires. Embouts en aluminium moulé sous pression.

Équipé de plaques d'acier pour la fixation à la structure métallique des bureaux.

Couleurs: **W** Blanc RAL9003 - **Y** Aluminium brillant

Écran anti-bruit

Les surfaces du panneau sont revêtues en tissu de polyester Trevira CS[®], appliqué solidement au rembourrage intérieur, avec lequel il s'intègre complètement.

Ils peuvent être appliqués aussi bien à la barre porte-accessoires, que au petits plateaux surélevés.

Couleurs: **GT** Gris argent - **KT** Noir – **RT** Rouge -**DT** Bleu
- **BT** Beige

Voile de fond

Mélamine de qualité E1.

Épaisseur 1,8 cm, avec chant en ABS sur tous les côtés.

Équipé de plaques d'acier pour la fixation à la structure métallique des bureaux

Couleurs: **G** Gris clair **W** Blanc - **RC** Chêne clair - **NA**
Noyer Ambra - **WE** Wengé

Tablette surélevée

Mélamine de qualité E1.

Épaisseur 1,8 cm.

Couleurs: **G** Gris clair **W** Blanc - **RC** Chêne clair - **NA**
Noyer Ambra - **WE** Wengé

Supports de structure en plastique pigmenté renforcé de fibre de verre.

Couleurs: **W** Blanc RAL9003 – **Y** Aluminium brillant

Caissons à roulettes, caissons porteurs, dessertes

Structure

Mélamine, qualité E1.

Épaisseur 1,8 - 2,8 cm

Équipé de 4 roulettes plastique/acier grande durabilité (caisson à roulettes avec fichier muni d'une 5ème roulette) ou de pieds réglables, plastique et acier (caissons porteurs - dessertes).

Couleurs: **G** Gris clair **W** Blanc - **RC** Chêne clair - **NA**
Noyer Ambra - **WE** Wengé - **Z** Aluminium gaufré

Façades

Mélamine, qualité E1.

Épaisseur 1,8 cm, avec chant en ABS sur tous les côtés.

Façades de tiroirs avec serrure à blocage simultané.

Tiroirs internes en métal sur coulisses

(extraction totale pour tiroir D.S.) et système anti-basculement.

Portes équipées de serrure et de charnières d'ouverture à 110 °

Couleurs: **G** Gris clair **W** Blanc - **RC** Chêne clair - **NA**
Noyer Ambra - **WE** Wengé - **Z** Aluminium gaufré

Poignées

Plastique: ABS finition Aluminium RAL9006

Métal: aluminium moulé sous pression finition chromée

Peso, volume, colli
Weight, volume, packages
Poids, volume, colis

Codice Code Code	Peso Weight Poids kg	Volume Volume Volume m³	Colli Packages Colis n°	Codice Code Code	Peso Weight Poids kg	Volume Volume Volume m³	Colli Packages Colis n°	Codice Code Code	Peso Weight Poids kg	Volume Volume Volume m³	Colli Packages Colis n°
52282	31,51	0,109	5	55045	108,8	0,269	9	55122	20,22	0,114	4
52284	34,15	0,113	5	55050	49,2	0,187	6	55123	22,35	0,118	4
55001	52,93	0,118	5	55051	49,2	0,187	6	55124	24,48	0,121	4
55002	58,46	0,125	5	55052	54,73	0,193	6	55125	26,61	0,125	4
55003	64	0,132	5	55053	54,73	0,193	6	55132	25,02	0,148	4
55006	75,8	0,157	5	55054	60,26	0,201	6	55133	27,65	0,153	4
55007	82,53	0,164	5	55055	60,26	0,201	6	55134	30,28	0,157	4
55008	70,8	0,177	8	55058	73,06	0,242	6	55135	32,91	0,162	4
55009	109,8	0,249	8	55059	73,06	0,242	6	55136	38,21	0,198	4
55011	50,2	0,177	5	55060	79,8	0,249	6	55137	41,35	0,203	4
55012	55,73	0,183	5	55061	79,8	0,249	6	55138	37,94	0,228	6
55013	61,26	0,191	5	55062	67,34	0,281	9	55139	56,36	0,31	6
55016	73,06	0,232	5	55063	67,34	0,281	9	55142	27,65	0,078	4
55017	79,8	0,239	5	55064	116,4	0,385	9	55143	30,58	0,083	4
55018	67,34	0,262	8	55065	116,4	0,385	9	55144	33,51	0,088	4
55019	106,4	0,36	7	55070	62,5	0,142	6	55146	36,55	0,092	4
55021	25,27	0,052	5	55071	62,5	0,142	6	55152	34,05	0,1	4
55022	29,6	0,058	5	55072	75,3	0,173	6	55153	37,78	0,105	4
55023	23,9	0,075	5	55073	75,3	0,173	6	55154	41,51	0,112	4
55024	28,23	0,08	5	55074	82,03	0,18	6	55155	45,15	0,117	4
55025	20,77	0,026	5	55075	82,03	0,18	6	55156	52,85	0,141	4
55026	25,1	0,032	5	55078	108,8	0,269	9	55157	57,28	0,148	4
55027	20,77	0,026	5	55079	108,8	0,269	9	55158	51,2	0,158	6
55028	25,1	0,032	5	55082	37,86	0,057	6	55159	77,12	0,225	6
55030	50,93	0,128	6	55083	42,2	0,062	6	55162	24,92	0,121	4
55031	50,93	0,128	6	55102	22,95	0,071	4	55163	27,85	0,127	4
55032	56,46	0,135	6	55103	25,08	0,074	4	55164	30,78	0,131	4
55033	56,46	0,135	6	55104	27,21	0,078	4	55165	33,81	0,136	4
55034	62	0,142	6	55105	29,35	0,081	4	55172	31,32	0,158	4
55035	62	0,142	6	55112	27,75	0,09	4	55173	35,05	0,164	4
55038	74,8	0,173	6	55113	30,38	0,094	4	55174	38,78	0,17	4
55039	74,8	0,173	6	55114	33,01	0,099	4	55175	42,41	0,176	4
55040	81,53	0,18	6	55115	35,65	0,103	4	55176	50,11	0,216	4
55041	81,53	0,18	6	55116	40,95	0,123	4	55177	54,55	0,223	4
55042	69,8	0,195	9	55117	44,08	0,128	4	55178	47,74	0,243	6
55043	69,8	0,195	9	55118	41,4	0,143	6	55179	73,66	0,336	6
55044	108,8	0,269	9	55119	59,82	0,199	6	55181	15,07	0,044	5

FLY 01/02/03

Codice Code Code	Peso Weight Poids kg	Volume Volume Volume m³	Colli Packages Colis n°	Codice Code Code	Peso Weight Poids kg	Volume Volume Volume m³	Colli Packages Colis n°	Codice Code Code	Peso Weight Poids kg	Volume Volume Volume m³	Colli Packages Colis n°
55182	17,2	0,048	5	55230	41,35	0,213	5	55289	40,45	0,139	5
55183	13,7	0,067	5	55231	41,35	0,213	5	55290	43,58	0,144	5
55184	15,83	0,07	5	55232	37,94	0,247	7	55291	43,58	0,144	5
55185	18,27	0,048	5	55233	37,94	0,247	7	55294	58,82	0,219	7
55186	21,2	0,054	5	55234	56,36	0,335	7	55295	58,82	0,219	7
55187	16,9	0,071	5	55235	56,36	0,335	7	55302	40,01	0,122	5
55188	19,83	0,076	5	55240	35,78	0,115	5	55303	40,01	0,122	5
55191	10,57	0,018	5	55241	35,78	0,115	5	55304	43,65	0,127	5
55192	12,7	0,022	5	55242	39,51	0,122	5	55305	43,65	0,127	5
55193	10,2	0,018	5	55243	39,51	0,122	5	55308	52,35	0,157	5
55194	12,33	0,021	5	55244	43,15	0,127	5	55309	52,35	0,157	5
55195	13,77	0,022	5	55245	43,15	0,127	5	55310	56,78	0,164	5
55196	16,7	0,028	5	55248	51,85	0,157	5	55311	56,78	0,164	5
55197	13,4	0,022	5	55249	51,85	0,157	5	55314	76,12	0,245	7
55198	16,33	0,027	5	55250	56,28	0,164	5	55315	76,12	0,245	7
55200	28,38	0,104	5	55251	56,28	0,164	5	55322	18,21	0,035	5
55201	28,38	0,104	5	55252	50,2	0,176	7	55323	20,35	0,038	5
55202	31,01	0,109	5	55253	50,2	0,176	7	55325	24,51	0,045	5
55203	31,01	0,109	5	55254	76,12	0,245	7	55326	27,55	0,049	5
55204	33,65	0,113	5	55255	76,12	0,245	7	55332	17,95	0,053	4
55205	33,65	0,113	5	55260	34,05	0,174	5	55333	20,08	0,056	4
55208	39,95	0,139	5	55261	34,05	0,174	5	55334	22,21	0,06	4
55209	39,95	0,139	5	55262	37,78	0,18	5	55335	24,35	0,063	4
55210	43,08	0,144	5	55263	37,78	0,18	5	55342	21,75	0,065	4
55211	43,08	0,144	5	55264	41,41	0,186	5	55343	24,38	0,069	4
55212	40,4	0,161	7	55265	41,41	0,186	5	55344	27,01	0,074	4
55213	40,4	0,161	7	55268	50,11	0,226	5	55345	29,65	0,078	4
55214	58,82	0,219	7	55269	50,11	0,226	5	55346	34,95	0,094	4
55215	58,82	0,219	7	55270	54,55	0,233	5	55347	38,08	0,099	4
55220	26,65	0,163	5	55271	54,55	0,233	5	55352	15,97	0,069	4
55221	26,65	0,163	5	55272	47,74	0,262	7	55353	18,1	0,073	4
55222	29,28	0,167	5	55273	47,74	0,262	7	55354	20,23	0,076	4
55223	29,28	0,167	5	55274	73,66	0,361	7	55355	22,36	0,08	4
55224	31,91	0,172	5	55275	73,66	0,361	7	55362	19,77	0,088	4
55225	31,91	0,172	5	55283	31,51	0,109	5	55363	22,4	0,093	4
55228	38,21	0,208	5	55285	34,15	0,113	5	55364	25,03	0,097	4
55229	38,21	0,208	5	55288	40,45	0,139	5	55365	27,66	0,102	4

Codice Code Code	Peso Weight Poids kg	Volume Volume Volume m³	Colli Packages Colis n°	Codice Code Code	Peso Weight Poids kg	Volume Volume Volume m³	Colli Packages Colis n°	Codice Code Code	Peso Weight Poids kg	Volume Volume Volume m³	Colli Packages Colis n°
55366	33,21	0,128	4	55429	27,65	0,078	4	55486	33,51	0,087	4
55367	36,35	0,133	4	55430	32,95	0,094	4	55487	33,51	0,087	4
55372	22,65	0,06	4	55431	32,95	0,094	4	55488	37,15	0,092	4
55373	25,58	0,065	4	55432	36,08	0,099	4	55489	37,15	0,092	4
55374	28,51	0,07	4	55433	36,08	0,099	4	55490	44,85	0,112	4
55375	31,55	0,074	4	55442	15,72	0,074	4	55491	44,85	0,112	4
55382	28,05	0,075	4	55443	15,72	0,074	4	55492	49,28	0,119	4
55383	31,78	0,08	4	55444	17,85	0,078	4	55493	49,28	0,119	4
55384	35,51	0,087	4	55445	17,85	0,078	4	55502	20,42	0,081	4
55385	39,15	0,092	4	55446	19,98	0,081	4	55503	20,42	0,081	4
55386	46,85	0,112	4	55447	19,98	0,081	4	55504	23,35	0,087	4
55387	51,28	0,119	4	55448	22,11	0,085	4	55505	23,35	0,087	4
55392	20,67	0,076	4	55449	22,11	0,085	4	55506	26,28	0,091	4
55393	23,6	0,082	4	55452	19,02	0,093	4	55507	26,28	0,091	4
55394	26,53	0,086	4	55453	19,02	0,093	4	55508	29,31	0,096	4
55395	29,56	0,091	4	55454	21,65	0,098	4	55509	29,31	0,096	4
55402	26,07	0,098	4	55455	21,65	0,098	4	55512	25,32	0,103	4
55403	29,8	0,104	4	55456	24,28	0,102	4	55513	25,32	0,103	4
55404	33,53	0,11	4	55457	24,28	0,102	4	55514	29,05	0,109	4
55405	37,16	0,116	4	55458	26,91	0,107	4	55515	29,05	0,109	4
55406	45,11	0,146	4	55459	26,91	0,107	4	55516	32,78	0,115	4
55407	49,55	0,153	4	55460	32,21	0,128	4	55517	32,78	0,115	4
55412	15,95	0,053	4	55461	32,21	0,128	4	55518	36,41	0,121	4
55413	15,95	0,053	4	55462	35,35	0,133	4	55519	36,41	0,121	4
55414	18,08	0,056	4	55463	35,35	0,133	4	55520	44,11	0,146	4
55415	18,08	0,056	4	55472	20,65	0,06	4	55521	44,11	0,146	4
55416	20,21	0,06	4	55473	20,65	0,06	4	55522	48,55	0,153	4
55417	20,21	0,06	4	55474	23,58	0,065	4	55523	48,55	0,153	4
55418	22,35	0,063	4	55475	23,58	0,065	4	55536	20,71	0,06	4
55419	22,35	0,063	4	55476	26,51	0,07	4	55537	20,71	0,06	4
55422	19,75	0,065	4	55477	26,51	0,07	4	55538	22,85	0,063	4
55423	19,75	0,065	4	55478	29,55	0,074	4	55539	22,85	0,063	4
55424	22,38	0,069	4	55479	29,55	0,074	4	55546	25,51	0,074	4
55425	22,38	0,069	4	55482	26,05	0,075	4	55547	25,51	0,074	4
55426	25,01	0,074	4	55483	26,05	0,075	4	55548	28,15	0,078	4
55427	25,01	0,074	4	55484	29,78	0,08	4	55549	28,15	0,078	4
55428	27,65	0,078	4	55485	29,78	0,08	4	55550	33,45	0,094	4

Codice Code Code	Peso Weight Poids kg	Volume Volume Volume m³	Colli Packages Colis n°	Codice Code Code	Peso Weight Poids kg	Volume Volume Volume m³	Colli Packages Colis n°	Codice Code Code	Peso Weight Poids kg	Volume Volume Volume m³	Colli Packages Colis n°
55551	33,45	0,094	4	55634	29,51	0,052	3	55683	51,72	0,093	8
55552	36,58	0,099	4	55635	33,15	0,057	3	55684	56	0,099	8
55553	36,58	0,099	4	55636	39,85	0,067	3	55686	53,9	0,095	8
55566	27,01	0,07	4	55637	44,28	0,074	3	55687	59,16	0,103	8
55567	27,01	0,07	4	55641	5	0,027	2	55688	64,42	0,113	8
55568	30,05	0,074	4	55642	6	0,035	2	55689	69,7	0,121	8
55569	30,05	0,074	4	55643	7	0,045	2	55691	52,6	0,093	8
55576	34,01	0,087	4	55645	4	0,05	2	55692	58,46	0,103	8
55577	34,01	0,087	4	55646	5	0,065	2	55693	64,32	0,113	8
55578	37,65	0,092	4	55647	6	0,08	2	55694	70,4	0,121	8
55579	37,65	0,092	4	55651	3	0,027	2	55696	66,5	0,115	8
55580	45,35	0,112	4	55652	4	0,035	2	55697	73,96	0,125	8
55581	45,35	0,112	4	55653	5	0,045	2	55698	81,42	0,139	8
55582	49,78	0,119	4	55655	3,5	0,05	2	55699	88,7	0,149	8
55583	49,78	0,119	4	55656	4	0,065	2	55702	33,9	0,106	7
55585	5	0,027	1	55657	5	0,08	2	55703	38,16	0,112	7
55586	6	0,035	1	55661	3,5	0,027	2	55704	42,42	0,12	7
55587	7	0,045	1	55662	4,5	0,035	2	55705	46,7	0,126	7
55591	4	0,05	1	55663	5,5	0,045	2	55712	40,5	0,13	7
55592	5	0,065	1	55664	21,5	0,039	5	55713	45,76	0,138	7
55593	6	0,08	1	55665	24	0,042	5	55714	51,02	0,148	7
55602	12,95	0,026	3	55666	26	0,046	5	55715	56,3	0,156	7
55603	15,08	0,029	3	55667	28	0,049	5	55722	31,44	0,147	7
55604	17,21	0,033	3	55668	27	0,046	5	55723	35,7	0,155	7
55605	19,35	0,036	3	55669	29,5	0,05	5	55724	39,96	0,161	7
55612	15,75	0,03	3	55670	32	0,055	5	55725	44,22	0,169	7
55613	18,38	0,034	3	55671	35	0,059	5	55732	38,04	0,186	7
55614	21,01	0,039	3	55672	26,5	0,046	5	55733	43,3	0,196	7
55615	23,65	0,043	3	55673	29	0,051	5	55734	48,56	0,204	7
55616	27,95	0,049	3	55674	32	0,056	5	55735	53,82	0,214	7
55617	31,08	0,054	3	55675	35	0,06	5	55742	43,3	0,12	7
55622	17,65	0,033	3	55676	33	0,056	5	55743	49,16	0,13	7
55623	20,58	0,038	3	55677	37	0,061	5	55744	55,02	0,14	7
55624	23,51	0,043	3	55678	41	0,068	5	55745	61,1	0,148	7
55625	26,55	0,047	3	55679	44,5	0,073	5	55752	53,1	0,15	7
55632	22,05	0,04	3	55681	43,2	0,079	8	55753	60,56	0,16	7
55633	25,78	0,045	3	55682	47,46	0,085	8	55754	68,02	0,174	7

Codice Code Code	Peso Weight Poids kg	Volume Volume Volume m³	Colli Packages Colis n°	Codice Code Code	Peso Weight Poids kg	Volume Volume Volume m³	Colli Packages Colis n°	Codice Code Code	Peso Weight Poids kg	Volume Volume Volume m³	Colli Packages Colis n°
55755	75,3	0,184	7	55922	31,5	0,06	6	56035	49,7	0,081	10
55762	40,84	0,161	7	55923	36,76	0,068	6	56051	21,26	0,085	6
55763	46,7	0,173	7	55924	42,02	0,078	6	56052	25,16	0,106	6
55764	52,56	0,181	7	55925	47,3	0,086	6	56053	19,52	0,128	6
55765	58,62	0,191	7	55932	35,3	0,066	6	56054	23,42	0,164	6
55772	50,64	0,206	7	55933	41,16	0,076	6	56055	26,16	0,093	6
55773	58,1	0,218	7	55934	47,02	0,086	6	56056	31,66	0,116	6
55774	65,56	0,23	7	55935	53,1	0,094	6	56057	24,42	0,136	6
55775	72,82	0,242	7	55942	44,1	0,08	6	56058	29,92	0,174	6
55802	28,4	0,055	7	55943	51,56	0,09	6	56091	8	0,054	3
55803	32,66	0,061	7	55944	59,02	0,104	6	56092	9	0,07	3
55804	36,92	0,069	7	55945	66,3	0,114	6	56094	7	0,099	3
55805	41,2	0,075	7	55971	15,07	0,044	5	56095	8	0,13	3
55812	35	0,064	7	55972	17,2	0,048	5	56101	2,5	0,003	3
55813	40,26	0,072	7	55973	13,7	0,067	5	56102	3,5	0,004	3
55814	45,52	0,082	7	55974	15,83	0,07	5	56106	5	0,05	3
55815	50,8	0,09	7	55975	18,27	0,048	5	56107	6	0,06	3
55842	37,8	0,069	7	55976	21,2	0,054	5	56108	5	0,05	3
55843	43,66	0,079	7	55977	16,9	0,071	5	56109	6	0,06	3
55844	49,52	0,089	7	55978	19,83	0,076	5	56205	32,9	0,098	7
55845	55,6	0,097	7	56003	26,4	0,133	9	56206	50,32	0,14	7
55852	47,6	0,084	7	56004	30,66	0,139	9	56207	33,9	0,153	7
55853	55,06	0,094	7	56007	32,8	0,141	9	56208	51,32	0,21	7
55854	62,52	0,108	7	56008	38,66	0,151	9	56211	42,7	0,113	7
55855	69,8	0,118	7	56011	21,14	0,036	10	56212	67,62	0,166	7
55884	39,42	0,116	7	56012	25,4	0,044	10	56213	43,7	0,168	7
55885	43,7	0,122	7	56014	27,54	0,044	10	56214	68,62	0,236	7
55887	48,02	0,138	7	56015	33,4	0,056	10	56231	47,9	0,198	5
55888	53,3	0,146	7	56021	8	0,054	1	56232	28,9	0,167	3
55894	52,02	0,136	7	56022	9	0,07	1	56291	29,2	0,16	2
55895	58,1	0,144	7	56024	7	0,099	1	56292	30	0,16	2
55897	65,02	0,164	7	56025	8	0,13	1	56294	28,2	0,16	2
55898	72,3	0,174	7	56027	17,3	0,027	2	56295	28,5	0,16	2
55912	25,9	0,052	6	56028	22,4	0,035	2	56305	0,1	0,001	1
55913	30,16	0,058	6	56031	37,44	0,061	10	56311	25,2	0,181	2
55914	34,42	0,066	6	56032	41,7	0,069	10	56312	26	0,19	2
55915	38,7	0,072	6	56034	43,84	0,069	10	56313	24,2	0,181	2

FLY 01/02/03

Codice Code Code	Peso Weight Poids kg	Volume Volume Volume m³	Colli Packages Colis n°	Codice Code Code	Peso Weight Poids kg	Volume Volume Volume m³	Colli Packages Colis n°	Codice Code Code	Peso Weight Poids kg	Volume Volume Volume m³	Colli Packages Colis n°
56314	24,5	0,19	2	56429	5	0,076	2	56512	4,6	0,01	2
56321	51,2	0,501	2	56431	5,35	0,038	2	56513	5,4	0,012	2
56322	51,2	0,501	2	56432	6,39	0,04	2	56514	6,1	0,015	2
56323	51,5	0,51	2	56433	7,33	0,052	2	56515	6,9	0,017	2
56324	51,5	0,51	2	56434	8,28	0,054	2	56516	7,6	0,02	2
56326	55,2	0,501	2	56435	9,32	0,066	2	56517	8,4	0,022	2
56327	55,2	0,501	2	56436	10,26	0,078	2	56531	1,75	0,03	1
56328	55,5	0,51	2	56441	5,35	0,038	2	56532	2,19	0,03	1
56329	55,5	0,51	2	56442	6,39	0,04	2	56533	2,63	0,04	1
56330	54,2	0,501	2	56443	7,33	0,052	2	56534	3,08	0,04	1
56331	54,2	0,501	2	56444	8,28	0,054	2	56535	3,52	0,05	1
56332	55	0,51	2	56445	9,32	0,066	2	56536	3,96	0,06	1
56333	55	0,51	2	56446	10,26	0,078	2	56541	1,75	0,03	1
56341	52,4	0,502	3	56448	7,13	0,098	3	56542	2,19	0,03	1
56343	54	0,52	3	56449	8,52	0,126	3	56543	2,63	0,04	1
56345	50,4	0,502	3	56461	7,2	0,012	2	56544	3,08	0,04	1
56347	51	0,52	3	56462	8,5	0,015	2	56545	3,52	0,05	1
56351	42,2	0,341	2	56463	9,8	0,018	2	56546	3,96	0,06	1
56352	42,2	0,341	2	56464	11	0,021	2	56548	8	0,07	1
56353	43	0,35	2	56465	12,3	0,023	2	56549	9,5	0,09	1
56354	43	0,35	2	56466	13,6	0,026	2	56551	2	0,061	1
56355	43,4	0,502	3	56471	7,2	0,012	2	56571	9	0,03	1
56357	44	0,52	3	56472	8,5	0,015	2	56572	2	0,022	1
56359	42,2	0,501	2	56473	9,8	0,018	2	56573	3	0,031	1
56361	42,5	0,51	2	56474	11	0,021	2	56574	0,5	0,1	1
56367	1	0,04	1	56475	12,3	0,023	2				
56412	9,1	0,013	2	56476	13,6	0,026	2				
56413	10,7	0,016	2	56491	0,2	0,001	1				
56414	13,3	0,019	2	56492	0,3	0,001	1				
56415	14,9	0,022	2	56493	0,3	0,001	1				
56416	16,5	0,024	2	56494	0,4	0,001	1				
56422	6,39	0,04	2	56502	5,4	0,012	2				
56423	7,33	0,052	2	56503	6,1	0,015	2				
56424	8,28	0,054	2	56504	6,9	0,017	2				
56425	9,32	0,066	2	56505	7,6	0,02	2				
56426	10,26	0,078	2	56506	8,4	0,022	2				
56428	4,5	0,058	2	56507	9,1	0,025	2				

- 16 **Scrivanie, tavoli riunione**
Desks, meeting tables
Bureaux, tables de réunion
- 17 **Cassettiere su ruote, cassettiere portanti, serventi**
Drawer units on wheels, bearing, pedestals
Caissons à roulettes, caissons porteurs, dessertes
- 18 **Screen su barra accessori**
Screen on accessory bar
Écran sur barre d'accessoires
- 19 **Screen con telaio di alluminio perimetrale**
Screen with aluminium frame border
Écran avec cadre de pourtour en aluminium

Scrivanie, tavoli riunione

Desks, meeting tables

Bureaux, tables de réunion

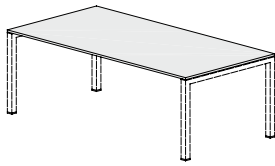

Piano nobilitato Melamine worktop Plateau mélaminé

G Grigio chiaro
Light grey
Gris clair

W Bianco
White
Blanc

RC Rovere chiaro
Light oak
Chêne clair

NA Noce Ambra
Ambra walnut
Noyer Ambra

WE Wenge
Wenge
Wengé

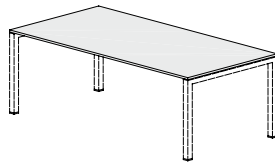

Piano vetro Glass worktop Plateau en verre

W Bianco
White
Blanc

KV Nero
Black
Noir

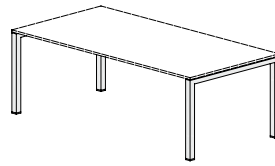

Struttura metallo Metal Structure Structure en métal

W Bianco RAL9003
RAL9003 white
Blanc RAL9003

Y Alluminio lucido
Glossy aluminium
Aluminium brillant

EQ Ecocromo
Eco-chrome
Éco chrome

Per una corretta compilazione dell'ordine bisogna indicare:

- **colore piano**
- **codice prodotto**
- **colore struttura metallica**

Esempio:
Scrivania rettangolare 180x80 con piano in nobilitato bianco spessore cm 2,8, struttura in metallo verniciato bianco RAL9003

Sigla colore piano **W**
Codice prodotto **55155**
Sigla colore struttura **W**

To correctly complete the order you must indicate:

- **worktop colour**
- **product code**
- **metallic structure colour**

Example:
180x180 rectangular desk with white melamine worktop, 2.8 cm thick, structure in RAL9003 white painted metal

Worktop colour code **W**
Product code **55155**
Structure colour code **W**

Pour remplir correctement le formulaire de la commande, indiquer:

- **la couleur du plateau**
- **le code du produit**
- **la couleur de la structure métallique**

Exemple:
Bureau rectangulaire 180x80 avec plateau en mélaminé blanc, 2,8 cm d'épaisseur, structure en métal peint en blanc RAL9003

Abréviation couleur du plateau **W**
Code du produit **55155**
Abréviation couleur de la structure **W**

Cassettiere su ruote, cassettiere portanti, serventi

Drawer units on wheels, bearing, pedestals

Caissons à roulettes, caissons porteurs, dessertes

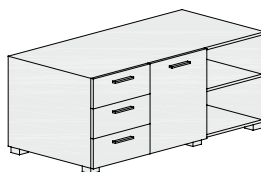
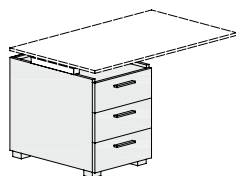

Struttura/frontale

Structure/front

Structure/façade

G Grigio chiaro
Light grey
Gris clair

W Bianco
White
Blanc

RC Rovere chiaro
Light oak
Chêne clair

NA Noce Ambra
Ambra walnut
Noyer Ambra

WE Wenge
Wenge
Wengé

Z Alluminio gofrato
Embossed aluminium
Aluminium gaufré

Struttura/frontale

Structure/front

Structure/façade

G Grigio chiaro
Light grey
Gris clair

W Bianco
White
Blanc

RC Rovere chiaro
Light oak
Chêne clair

NA Noce Ambra
Ambra walnut
Noyer Ambra

WE Wenge
Wenge
Wengé

Z Alluminio gofrato
Embossed aluminium
Aluminium gaufré

Struttura/frontale

Structure/front

Structure/façade

G Grigio chiaro
Light grey
Gris clair

W Bianco
White
Blanc

RC Rovere chiaro
Light oak
Chêne clair

NA Noce Ambra
Ambra walnut
Noyer Ambra

WE Wenge
Wenge
Wengé

Z Alluminio gofrato
Embossed aluminium
Aluminium gaufré

Per una corretta compilazione dell'ordine bisogna indicare:
- colore struttura/frontale
- codice prodotto

Esempio:
Cassettiera su ruote 3 cassetti in metallo in nobilitato bianco

Sigla colore struttura/frontali **W**
Codice prodotto **56301**

To correctly complete the order you must indicate:
- structure/front colour
- product code

Example:
Drawer unit on wheels, 3 metal drawers melamine white

Structure/front colour code **W**
Product code **56301**

Pour remplir correctement le formulaire de la commande, indiquer:
- la couleur de la structure/façade
- le code du produit

Exemple:
Caisson à roulettes 3 tiroirs en métal, mélaminé blanc

Abréviation couleur structure /façades **W**
Code du produit **56301**

Screen su barra accessori
 Screen on accessory bar
 Écran sur barre d'accessoires

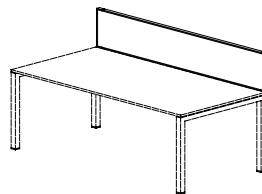
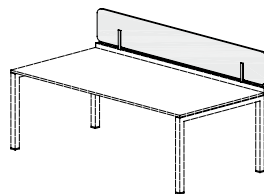
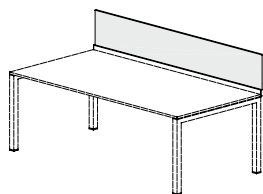
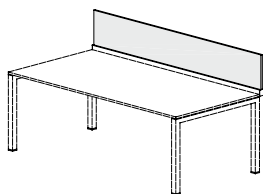

Nobilitato
 Melamine
 Mélamine

G Grigio chiaro
 Light grey
 Gris clair

W Bianco
 White
 Blanc

RC Rovere chiaro
 Light oak
 Chêne clair

NA Noce Ambra
 Ambra walnut
 Noyer Ambra

WE Wenge
 Wenge
 Wengé

Vetro
 Glass
 Verre

SV Satinato
 Satined
 Satiné

Tessuto Fonoassorbente
 Soundproof fabric
 Tissu anti-bruit

GT Grigio argento
 Silver grey
 Gris argent

KT Nero
 Black
 Noir

RT Rosso
 Red
 Rouge

DT Blu
 Blue
 Bleu

BT Beige
 Beige
 Beige

Profilo alluminio
 Aluminium profile
 Profilé en aluminium

W Bianco RAL9003
 RAL9003 White
 Blanc RAL9003

Y Alluminio lucido
 Glossy aluminium
 Aluminium brillant

Per una corretta compilazione dell'ordine bisogna indicare:
 - **colore screen**
 - **codice prodotto**
 - **colore profilo alluminio**

Esempio:
 Screen cm.160 in nobilitato bianco con profilo di alluminio verniciato bianco RAL9003

Sigla colore screen **W**
 Codice prodotto **56435**
 Sigla colore profilo alluminio **W**

To correctly complete the order you must indicate:
 - **screen colour**
 - **product code**
 - **aluminium profile colour**

Example:
 160 cm melamine white screen with RAL9003 white painted aluminium profile

Screen colour code **W**
 Product code **56435**
 Aluminium profile colour code **W**

Pour remplir correctement le formulaire de la commande, indiquer:
 - **la couleur de l'écran**
 - **le code du produit**
 - **la couleur de la cadre de aluminium**

Exemple:
 Ecran melamine 160 cm blanc avec cadre blanc RAL9003 blanc

Abréviation couleur écran **W**
 Code du produit **56435**
 Abréviation couleur de la structure **W**

Screen con telaio di alluminio perimetrale

Screen with aluminium frame border

Écran avec cadre de pourtour en aluminium

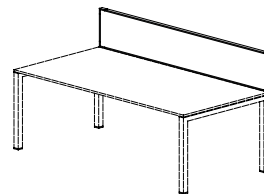
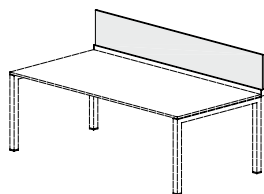
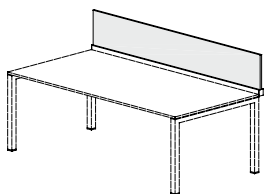

Nobilitato

Melamine

Mélamine

G Grigio chiaro
Light grey
Gris clair

W Bianco
White
Blanc

RC Rovere chiaro
Light oak
Chêne clair

NA Noce Ambra
Ambra walnut
Noyer Ambra

WE Wenge
Wenge
Wengé

Tessuto

Fabric

Tissu

DN Madrid nero
Madrid black
Madrid noir

DG Madrid grigio chiaro
Madrid light grey
Madrid gris clair

DS M adrid grigio scuro
Madrid dark grey
Madrid gris foncé

DR M adrid rosso
Madrid red
Madrid rouge

DB M adrid blu
Madrid blue
Madrid bleu

MN Mirage nero
Mirage black
Mirage noir

MG Mirage grigio
Mirage grey
Mirage gris

MR Mirage rosso
Mirage red
Mirage rouge

MB Mirage blu
Mirage blue
Mirage bleu

MT M irage tortora
Mirage dove grey
Mirage gris tourterelle

MP M irage panna
Mirage cream
Mirage crème

MA Mirage arancione
Mirage orange
Mirage orange

MX Mirage bordeaux
Mirage bordeaux
Mirage bordeaux

MV Mirage verde
Mirage green
Mirage vert

Profilo alluminio

Aluminium profile

Profilé en aluminium

W Bianco RAL9003
RAL9003 White
Blanc RAL9003

Y Alluminio lucido
Glossy aluminium
Aluminium brillant

Per una corretta compilazione dell'ordine bisogna indicare:

- colore screen
- codice prodotto
- colore profilo alluminio

Esempio:
Screen cm.160 in nobilitato bianco con profilo di alluminio verniciato bianco RAL9003

Sigla colore screen **W**
Codice prodotto **56465**
Sigla colore profilo alluminio **W**

To correctly complete the order you must indicate:

- screen colour
- product code
- aluminium profile colour

Example:
160 cm melamine white screen with RAL9003 white painted aluminium profile

Screen colour code **W**
Product code **56465**
Aluminium profile colour code **W**

Pour remplir correctement le formulaire de la commande, indiquer:

- la couleur de l'écran
- le code du produit
- la couleur du profilé en aluminium

Exemple:
Écran 160 cm, en mélaminé blanc, profilé en aluminium peint blanc RAL9003

Abréviation couleur écran **W**
Code du produit **56465**
Abréviation couleur profilé aluminium **W**

Esplicativo dimensionale scrivanie con servente portante
 Desk size with bearing pedestal explanation
 Détails des dimensions pour bureaux avec desserte porteuse

DESCRIZIONE

Il sistema FLY prevede l'utilizzo di serventi strutturali assemblati alla struttura delle scrivanie. Il servente strutturale H63 può essere fissato alla struttura in 3 posizioni, consentendo così di avere un'ingombro interno al piano della scrivania variabile.

Several structural pedestals assembled to the desk structures can be used with the FLY system. Structural pedestals H63 can be fitted to the structure in 3 positions which provides a variable dimension within the desk worktop.

Le système prévoit l'utilisation des dessertes structurelles assemblées à la structure des bureaux. La desserte structurelle H63 peut être fixée à la structure dans 3 positions différentes, ce qui permet d'avoir un encombrement variable hors du plan de travail.

FLY01

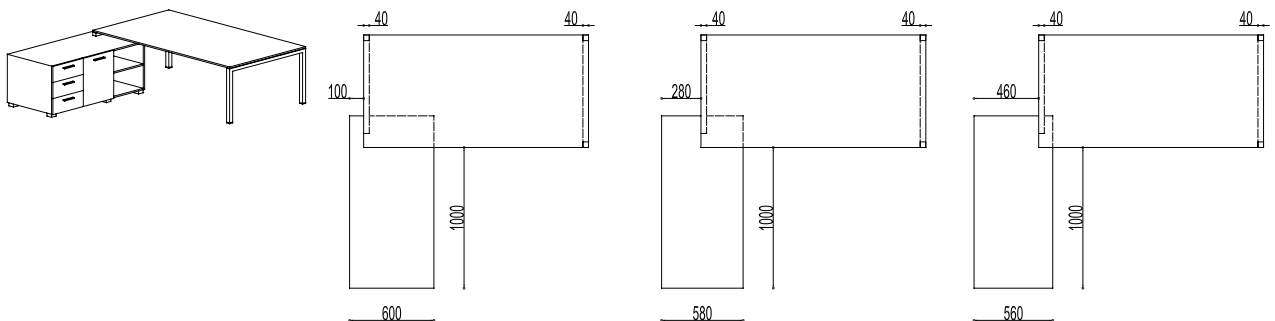

FLY02

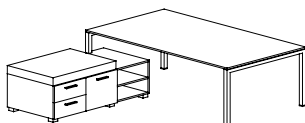
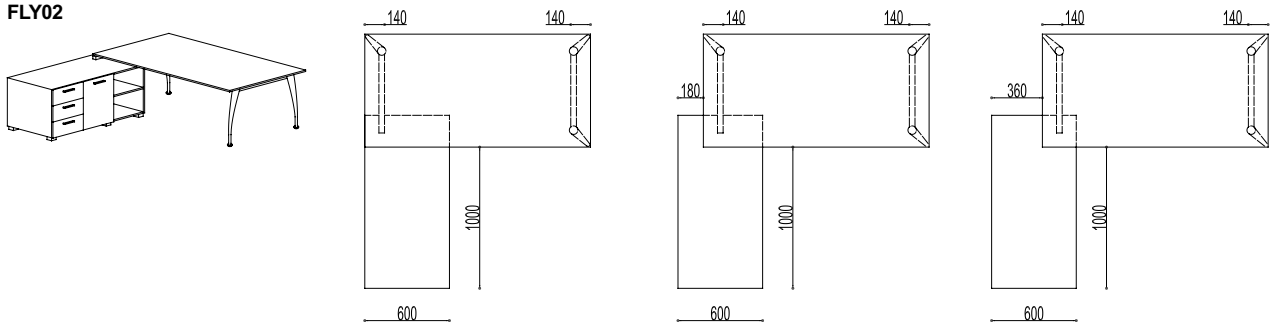

Il servente strutturale H43 può essere fissato alla struttura delle scrivanie FLY01 solamante in posizione terminale per avere un'allineamento perfetto con il piano superiore.

Structural pedestal H43 can be fitted to the FLY01 desk structure only at the end in order to obtain perfect alignment with the worktop.

La desserte structurelle H43 peut être fixée à la structure des bureaux FLY01 uniquement en position terminale pour avoir un alignement parfait avec le plan de travail plus haut.

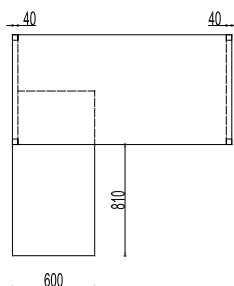

Esplicativo fori passacavi e top access
 Slot for cable management and top access explanation
 Détails encoches passe-câbles et top access

DESCRIZIONE

Fori per passaggio cavi ø6 – ø8 cm. (vedi listino Elementi Comuni art.47351 – 47352 – 43505 – 43506)

ø6 – ø8 cm slot for cable management (see General elements Price List Art.47351 – 47352 – 43505 – 43506)

Passe-câbles ø6 - ø8 cm. (Voir tarif Eléments communs art.47351 - 47352 - 43505 - 43506)

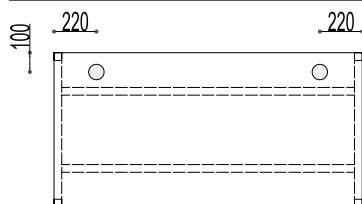

FLY01

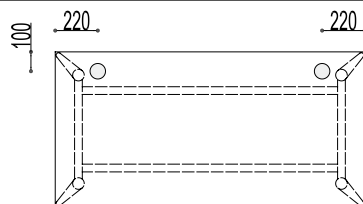

FLY02

Top access con coperchio con apertura basculante (vedi listino Elementi Comuni art.47353) non realizzabile in presenza di screen

Top access with swing-opening cover (see General elements Price List Art. 47353) not possible with screen

Top access avec couvercle à ouverture basculante (Voir tarif Eléments communs art.47353) il n'est pas possible avec écran

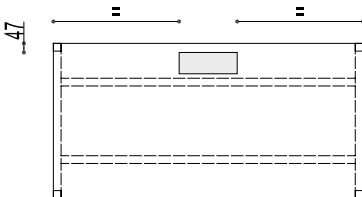
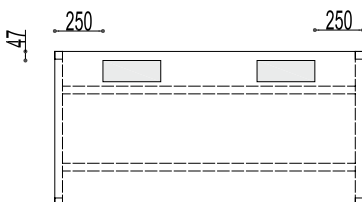

FLY01

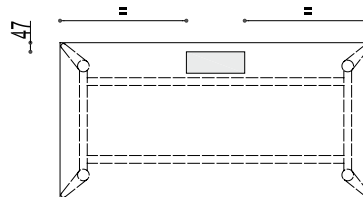
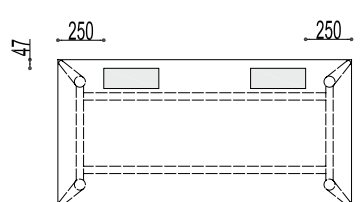

FLY02

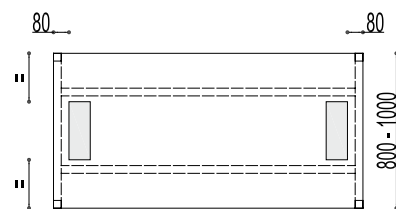

FLY01

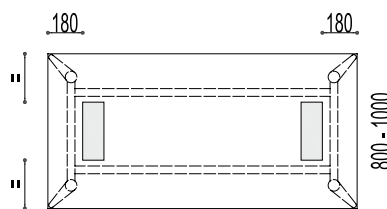

FLY02

Top access con coperchio ad apertura a scatto (vedi listino Elementi Comuni art.3842)

Top access with catch-opening cover (see General elements Price List Art. 47353)

Top access avec couvercle à ressort (Voir tarif Eléments communs art.3842)

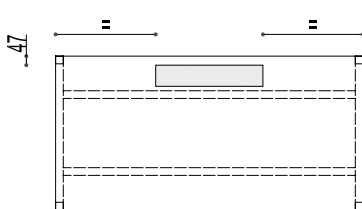

FLY01

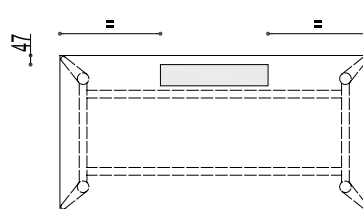

FLY02

FLY 01/02/03

COMP. 01

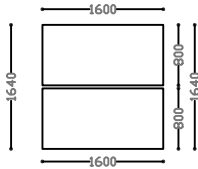

Composizione da 2 posti con scrivania 160x80 cm. Finiture piani W – RC – NA – WE

Composition for two operators with 160x80 cm worktop. Worktop finishes W – RC – NA – WE

Composition pour 2 opérateur avec bureaux 160x80 cm. Coloris de bureaux W – RC – NA – WE

SP.	nessun accessorio no accessories no accessoires		barra e screen melaminico aluminium bar and melamine screen / barre en aluminium avec écran melaminé		barra e screen vetro / aluminium bar and glass screen / barre en aluminium avec écran en verre		screen melaminico con telaio / melamine screen with frame / écran mélamine avec cadre		screen in tessuto Madrid con telaio / Madrid fabric screen with frame / écran en tissu Madrid avec cadre		screen con barra su piano sopraelevato / screen on bar above raised shelf / écran avec barre sur tablette surélevée	
	18mm	28mm	18mm	28mm	18mm	28mm	18mm	28mm	18mm	28mm	18mm	28mm
FLY 01	708,00	769,00	1.112,00	1.173,00	1.239,00	1.300,00	1.016,00	1.077,00	1.152,00	1.213,00	1.052,00	1.113,00
FLY 02	645,00	706,00	1.049,00	1.110,00	1.176,00	1.237,00	953,00	1.014,00	1.089,00	1.150,00	989,00	1.050,00
FLY 03	695,00	756,00	1.099,00	1.160,00	1.226,00	1.287,00	1.003,00	1.064,00	1.139,00	1.200,00	1.039,00	1.100,00

COMP. 02 - servente H 63 cm

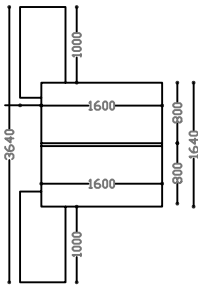

Composizione da 2 posti con scrivania 160x80 cm e servente H63. Finiture piani/serventi W – RC – NA – WE

Composition for two operators with 160x80 cm worktop and H63 pedestal. Worktop/pedestal finishes W – RC – NA – WE

Composition pour 2 opérateur avec bureaux 160x80 cm et dessertes H63. Coloris de bureaux/dessertes W – RC – NA – WE

SP.	nessun accessorio no accessories no accessoires		barra e screen melaminico aluminium bar and melamine screen / barre en aluminium avec écran melaminé		barra e screen vetro / aluminium bar and glass screen / barre en aluminium avec écran en verre		screen melaminico con telaio / melamine screen with frame / écran mélamine avec cadre		screen in tessuto Madrid con telaio / Madrid fabric screen with frame / écran en tissu Madrid avec cadre		screen con barra su piano sopraelevato / screen on bar above raised shelf / écran avec barre sur tablette surélevée	
	18mm	28mm	18mm	28mm	18mm	28mm	18mm	28mm	18mm	28mm	18mm	28mm
FLY 01	1.815,00	1.876,00	2.219,00	2.280,00	2.346,00	2.407,00	2.123,00	2.184,00	2.259,00	2.320,00	2.159,00	2.220,00
FLY 02	1.787,00	1.848,00	2.191,00	2.252,00	2.318,00	2.379,00	2.095,00	2.156,00	2.231,00	2.292,00	2.131,00	2.192,00
FLY 03	1.808,00	1.869,00	2.212,00	2.273,00	2.339,00	2.400,00	2.116,00	2.177,00	2.252,00	2.313,00	2.152,00	2.213,00

COMP. 02a - servente H 43 cm

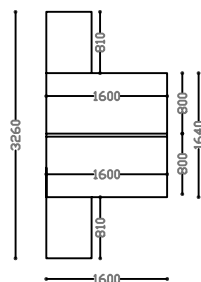

Composizione da 2 posti con scrivania 160x80 cm e servente H43. Finiture piani/serventi W – RC – NA – WE

Composition for two operators with 160x80 cm worktop and H43 pedestal. Worktop/pedestal finishes W – RC – NA – WE

Composition pour 2 opérateur avec bureaux 160x80 cm et dessertes H43. Coloris de bureaux/dessertes W – RC – NA – WE

SP.	nessun accessorio no accessories no accessoires		barra e screen melaminico aluminium bar and melamine screen / barre en aluminium avec écran melaminé		barra e screen vetro / aluminium bar and glass screen / barre en aluminium avec écran en verre		screen melaminico con telaio / melamine screen with frame / écran mélamine avec cadre		screen in tessuto Madrid con telaio / Madrid fabric screen with frame / écran en tissu Madrid avec cadre		screen con barra su piano sopraelevato / screen on bar above raised shelf / écran avec barre sur tablette surélevée	
	18mm	28mm	18mm	28mm	18mm	28mm	18mm	28mm	18mm	28mm	18mm	28mm
FLY 01	2.071,00	2.132,00	2.475,00	2.536,00	2.602,00	2.663,00	2.379,00	2.440,00	2.515,00	2.576,00	2.415,00	2.476,00
FLY 02	2.043,00	2.104,00	2.447,00	2.508,00	2.574,00	2.635,00	2.351,00	2.412,00	2.487,00	2.548,00	2.387,00	2.448,00
FLY 03	2.064,00	2.125,00	2.468,00	2.529,00	2.595,00	2.656,00	2.372,00	2.433,00	2.508,00	2.569,00	2.408,00	2.469,00

COMP. 03

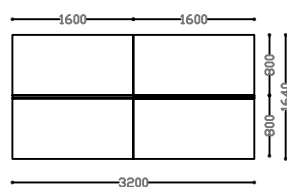

Composizione da 4 posti con scrivania 160x80 cm. Finiture piani W – RC – NA – WE

Composition for four operators with 160x80 cm worktop. Worktop finishes W – RC – NA – WE

Composition pour 4 opérateur avec bureaux 160x80 cm. Coloris de bureaux W – RC – NA – WE

SP.	nessun accessorio no accessories no accessoires		barra e screen melaminico aluminium bar and melamine screen / barre en aluminium avec écran melaminé		barra e screen vetro / aluminium bar and glass screen / barre en aluminium avec écran en verre		screen melaminico con telaio / melamine screen with frame / écran mélamine avec cadre		screen in tessuto Madrid con telaio / Madrid fabric screen with frame / écran en tissu Madrid avec cadre		screen con barra su piano sopraelevato / screen on bar above raised shelf / écran avec barre sur tablette surélevée	
	18mm	28mm	18mm	28mm	18mm	28mm	18mm	28mm	18mm	28mm	18mm	28mm
FLY 01	1.229,00	1.351,00	2.037,00	2.159,00	2.291,00	2.413,00	1.845,00	1.967,00	2.117,00	2.239,00	1.917,00	2.039,00
FLY 02	1.170,00	1.292,00	1.978,00	2.100,00	2.232,00	2.354,00	1.786,00	1.908,00	2.058,00	2.180,00	1.858,00	1.980,00
FLY 03	1.217,00	1.339,00	2.025,00	2.147,00	2.279,00	2.401,00	1.833,00	1.955,00	2.105,00	2.227,00	1.905,00	2.027,00

COMP. 04 - servente H 63 cm

Composizione da 4 posti con scrivania 160x80 cm e servente H63. Finiture piani/serventi W – RC – NA – WE

Composition for four operators with 160x80 cm worktop and H63 pedestal. Worktop/pedestal finishes W – RC – NA – WE

Composition pour 4 opérateur avec bureaux 160x80 cm et dessertes H63. Coloris de bureaux/dessertes W – RC – NA – WE

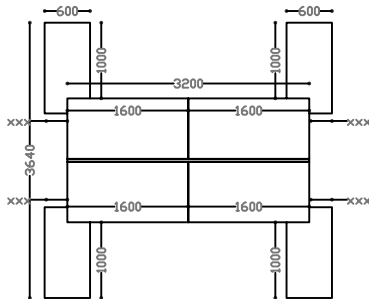

SP.	nessun accessorio no accessories no accessoires		barra e screen melaminico aluminium bar and melamine screen / barre en aluminium avec écran mélaminé		barra e screen vetro / aluminium bar and glass screen / barre en aluminium avec écran en verre		screen melaminico con telaio / melamine screen with frame / écran mélamine avec cadre		screen in tessuto Madrid con telaio / Madrid fabric screen with frame / écran en tissu Madrid avec cadre		screen con barra su piano sopraelevato / screen on bar above raised shelf / écran avec barre sur tablette surélevée	
	18mm	28mm	18mm	28mm	18mm	28mm	18mm	28mm	18mm	28mm	18mm	28mm
FLY 01	3.443,00	3.565,00	4.251,00	4.373,00	4.505,00	4.627,00	4.059,00	4.181,00	4.331,00	4.453,00	4.131,00	4.253,00
FLY 02	3.454,00	3.576,00	4.262,00	4.384,00	4.516,00	4.638,00	4.070,00	4.192,00	4.342,00	4.464,00	4.142,00	4.264,00
FLY 03	-	-	-	-	-	-	-	-	-	-	-	-

COMP. 04a - servente H 43 cm

Composizione da 4 posti con scrivania 160x80 cm e servente H43 e cuscino. Finiture piani/serventi W – RC – NA – WE

Composition for four operators with 160x80 cm worktop and H43 pedestal and cushion. Worktop/pedestal finishes W – RC – NA – WE

Composition pour 4 opérateur avec bureaux 160x80 cm et dessertes H43 et coussin. Coloris de bureaux/dessertes W – RC – NA – WE

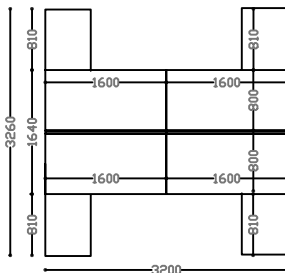

SP.	nessun accessorio no accessories no accessoires		barra e screen melaminico aluminium bar and melamine screen / barre en aluminium avec écran mélaminé		barra e screen vetro / aluminium bar and glass screen / barre en aluminium avec écran en verre		screen melaminico con telaio / melamine screen with frame / écran mélamine avec cadre		screen in tessuto Madrid con telaio / Madrid fabric screen with frame / écran en tissu Madrid avec cadre		screen con barra su piano sopraelevato / screen on bar above raised shelf / écran avec barre sur tablette surélevée	
	18mm	28mm	18mm	28mm	18mm	28mm	18mm	28mm	18mm	28mm	18mm	28mm
FLY 01	3.955,00	4.077,00	4.763,00	4.885,00	5.017,00	5.139,00	4.571,00	4.693,00	4.843,00	4.965,00	4.643,00	4.765,00
FLY 02	3.966,00	4.088,00	4.774,00	4.896,00	5.028,00	5.150,00	4.582,00	4.704,00	4.854,00	4.976,00	4.654,00	4.776,00
FLY 03	-	-	-	-	-	-	-	-	-	-	-	-

COMP. 05 - servente H 63 cm

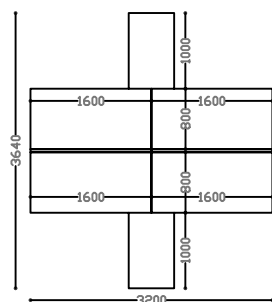

Composizione da 4 posti con scrivania 160x80 cm e servente bifacciale H63. Finiture piani/serventi W – RC – NA – WE

Composition for four operators with 160x80 cm worktop and double sided H63 pedestal. Worktop/pedestal finishes W – RC – NA – WE

Composition pour 4 opérateur avec bureaux 160x80 cm et dessertes double-face H63. Coloris de bureaux/dessertes W – RC – NA – WE

SP.	nessun accessorio no accessories no accessoires		barra e screen melaminico aluminium bar and melamine screen / barre en aluminium avec écran mélaminé		barra e screen vetro / aluminium bar and glass screen / barre en aluminium avec écran en verre		screen melaminico con telaio / melamine screen with frame / écran mélamine avec cadre		screen in tessuto Madrid con telaio / Madrid fabric screen with frame / écran en tissu Madrid avec cadre		screen con barra su piano sopraelevato / screen on bar above raised shelf / écran avec barre sur tablette surélevée	
	18mm	28mm	18mm	28mm	18mm	28mm	18mm	28mm	18mm	28mm	18mm	28mm
FLY 01	2.752,00	2.874,00	3.560,00	3.682,00	3.814,00	3.936,00	3.368,00	3.490,00	3.640,00	3.762,00	3.440,00	3.562,00
FLY 02	2.682,00	2.804,00	3.490,00	3.612,00	3.744,00	3.866,00	3.298,00	3.420,00	3.570,00	3.692,00	3.370,00	3.492,00
FLY 03	2.740,00	2.862,00	3.548,00	3.670,00	3.802,00	3.924,00	3.356,00	3.478,00	3.628,00	3.750,00	3.428,00	3.550,00

COMP. 05a - servente H 43 cm

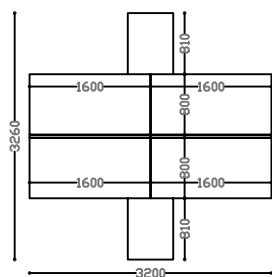

Composizione da 4 posti con scrivania 160x80 cm e servente bifacciale H43 e cuscino. Finiture piani/serventi W – RC – NA – WE

Composition for four operators with 160x80 cm worktop and double sided H43 pedestal and cushion. Worktop/pedestal finishes W – RC – NA – WE

Composition pour 4 opérateur avec bureaux 160x80 cm e dessertes double-face H43 et coussin. Coloris de bureaux/dessertes W – RC – NA – WE

SP.	nessun accessorio no accessories no accessoires		barra e screen melaminico aluminium bar and melamine screen / barre en aluminium avec écran mélaminé		barra e screen vetro / aluminium bar and glass screen / barre en aluminium avec écran en verre		screen melaminico con telaio / melamine screen with frame / écran mélamine avec cadre		screen in tessuto Madrid con telaio / Madrid fabric screen with frame / écran en tissu Madrid avec cadre		screen con barra su piano sopraelevato / screen on bar above raised shelf / écran avec barre sur tablette surélevée	
	18mm	28mm	18mm	28mm	18mm	28mm	18mm	28mm	18mm	28mm	18mm	28mm
FLY 01	2.671,00	2.793,00	3.479,00	3.601,00	3.733,00	3.855,00	3.287,00	3.409,00	3.559,00	3.681,00	3.359,00	3.481,00
FLY 02	2.601,00	2.723,00	3.409,00	3.531,00	3.663,00	3.785,00	3.217,00	3.339,00	3.489,00	3.611,00	3.289,00	3.411,00
FLY 03	2.659,00	2.781,00	3.467,00	3.589,00	3.721,00	3.843,00	3.275,00	3.397,00	3.547,00	3.669,00	3.347,00	3.469,00

COMP. 06

Composizione da 6 posti con scrivania 160x80 cm. Finiture piani W – RC – NA – WE

Composition for six operators with 160x80 cm worktop. Worktop finishes W – RC – NA – WE

Composition pour 6 opérateur avec bureaux 160x80 cm. Coloris de bureaux W – RC – NA – WE

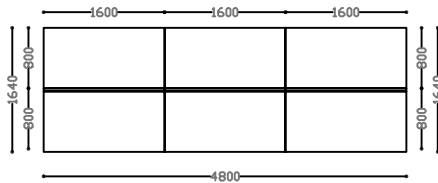

SP.	nessun accessorio no accessories no accessoires		barra e screen melaminico aluminium bar and melamine screen / barre en aluminium avec écran mélaminé		barra e screen vetro / aluminium bar and glass screen / barre en aluminium avec écran en verre		screen melaminico con telaio / melamine screen with frame / écran mélamine avec cadre		screen in tessuto Madrid con telaio / Madrid fabric screen with frame / écran en tissu Madrid avec cadre		screen con barra su piano sopraelevato / screen on bar above raised shelf / écran avec barre sur tablette surélevée	
	18mm	28mm	18mm	28mm	18mm	28mm	18mm	28mm	18mm	28mm	18mm	28mm
FLY 01	1.728,00	1.887,00	2.940,00	3.099,00	3.321,00	3.480,00	2.652,00	2.811,00	3.060,00	3.219,00	2.760,00	2.919,00
FLY 02	1.702,00	1.885,00	2.914,00	3.097,00	3.295,00	3.478,00	2.626,00	2.809,00	3.034,00	3.217,00	2.734,00	2.917,00
FLY 03	1.716,00	1.875,00	2.928,00	3.087,00	3.309,00	3.468,00	2.640,00	2.799,00	3.048,00	3.207,00	2.748,00	2.907,00

COMP. 07 - servente H 63 cm

Composizione da 6 posti con scrivania 160x80 cm e serventi monofacciale/bifacciale H63. Finiture piani/serventi W – RC – NA – WE

Composition for six operators with 160x80 cm worktop and single/double sided H63 pedestals. Worktop/ pedestal finishes W – RC – NA – WE

Composition pour 6 opérateur avec bureaux 160x80 cm et dessertes simple/double-face H63. Coloris de bureaux/dessertes W – RC – NA – WE

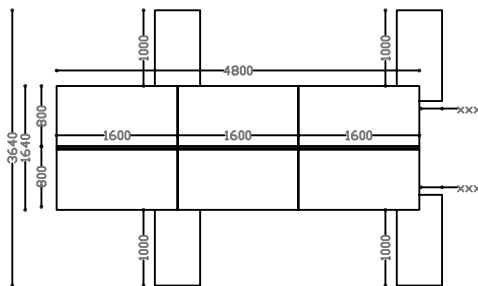

SP.	nessun accessorio no accessories no accessoires		barra e screen melaminico aluminium bar and melamine screen / barre en aluminium avec écran mélaminé		barra e screen vetro / aluminium bar and glass screen / barre en aluminium avec écran en verre		screen melaminico con telaio / melamine screen with frame / écran mélamine avec cadre		screen in tessuto Madrid con telaio / Madrid fabric screen with frame / écran en tissu Madrid avec cadre		screen con barra su piano sopraelevato / screen on bar above raised shelf / écran avec barre sur tablette surélevée	
	18mm	28mm	18mm	28mm	18mm	28mm	18mm	28mm	18mm	28mm	18mm	28mm
FLY 01	4.358,00	4.517,00	5.570,00	5.729,00	5.951,00	6.110,00	5.282,00	5.441,00	5.690,00	5.849,00	5.390,00	5.549,00
FLY 02	4.356,00	4.539,00	5.568,00	5.751,00	5.949,00	6.132,00	5.280,00	5.463,00	5.688,00	5.871,00	5.388,00	5.571,00
FLY 03	4.352,00	4.511,00	5.564,00	5.723,00	5.945,00	6.104,00	5.276,00	5.435,00	5.684,00	5.843,00	5.384,00	5.543,00

COMP. 07a - servente H 43 cm

Composizione da 6 posti con scrivania 160x80 cm e serventi monofacciale/bifacciale H43 e cuscino. Finiture piani/serventi W – RC – NA – WE

Composition for six operators with 160x80 cm worktop and single/double sided H43 pedestals and cushion. Worktop/pedestal finishes W – RC – NA – WE

Composition pour 6 opérateur avec bureaux 160x80 cm et dessertes simple/double-face H43 et coussin. Coloris de bureaux/dessertes W – RC – NA – WE

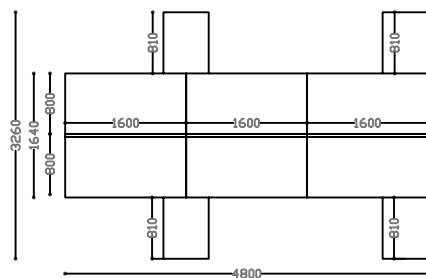

SP.	nessun accessorio no accessories no accessoires		barra e screen melaminico aluminium bar and melamine screen / barre en aluminium avec écran melaminé		barra e screen vetro / aluminium bar and glass screen / barre en aluminium avec écran en verre		screen melaminico con telaio / melamine screen with frame / écran mélamine avec cadre		screen in tessuto Madrid con telaio / Madrid fabric screen with frame / écran en tissu Madrid avec cadre		screen con barra su piano sopraelevato / screen on bar above raised shelf / écran avec barre sur tablette surélevée	
	18mm	28mm	18mm	28mm	18mm	28mm	18mm	28mm	18mm	28mm	18mm	28mm
FLY 01	4.533,00	4.692,00	5.745,00	5.904,00	6.126,00	6.285,00	5.457,00	5.616,00	5.865,00	6.024,00	5.565,00	5.724,00
FLY 02	4.531,00	4.714,00	5.743,00	5.926,00	6.124,00	6.307,00	5.455,00	5.638,00	5.863,00	6.046,00	5.563,00	5.746,00
FLY 03	4.527,00	4.686,00	5.739,00	5.898,00	6.120,00	6.279,00	5.451,00	5.610,00	5.859,00	6.018,00	5.559,00	5.718,00

ELEMENTO

DESCRIZIONE

Scrivanie con piano vetro
Desks with glass worktop
Bureaux avec plateau en verre

FLY01

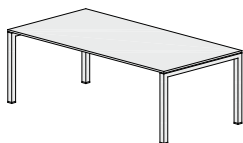

		Piano vetro / Glass worktop / Plateau en verre					
		Struttura / Structure / Structure: W - Y			Struttura / Structure / Structure: EQ		
		WV	KV		WV	KV	
MISURA	CODICE						
140x80	55001	1.049,00	903,00		1.288,00	1.142,00	
160x80	55002	1.141,00	975,00		1.381,00	1.214,00	
180x80	55003	1.245,00	1.058,00		1.484,00	1.297,00	
180x100	55006	1.532,00	1.300,00		1.769,00	1.536,00	
200x100	55007	1.647,00	1.389,00		1.884,00	1.626,00	
120x124	55008	1.592,00	1.400,00		1.851,00	1.659,00	
160x164	55009	2.259,00	1.923,00		2.603,00	2.267,00	
140x80	55011	1.058,00	921,00		1.292,00	1.146,00	
160x80	55012	1.149,00	983,00		1.383,00	1.217,00	
180x80	55013	1.249,00	1.062,00		1.483,00	1.296,00	
180x100	55016	1.469,00	1.237,00		1.739,00	1.507,00	
200x100	55017	1.586,00	1.329,00		1.857,00	1.599,00	
120x124	55018	1.533,00	1.341,00		1.804,00	1.611,00	
160x164	55019	2.196,00	1.860,00		2.489,00	2.153,00	

FLY02



ELEMENTO

DESCRIZIONE

Allungo laterale con piano in vetro completo di gamba cavalletto cm.60 e traverse in metallo

Return top with glass worktop complete with 60 cm trestle leg and metal crosspieces

Extension latérale plateau en verre, piètement 60 cm. et traverses en métal

FLY01

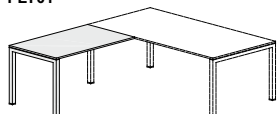

		Piano vetro / Glass worktop / Plateau en verre					
		Struttura / Structure / Structure: W - Y			Struttura / Structure / Structure: EQ		
MISURA	CODICE	WV	KV		WV	KV	
80x60	55021	554,00	490,00		674,00	610,00	
100x60	55022	630,00	551,00		750,00	670,00	
80x60	55023	564,00	501,00		676,00	612,00	
100x60	55024	641,00	562,00		753,00	674,00	

FLY02

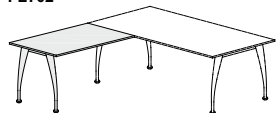

ELEMENTO

DESCRIZIONE

Allungo laterale con piano in vetro completo di traverse in metallo e supporto cassetiera. (ordinare cassetiera pag. 68)

Return top with glass worktop complete with metal crosspieces and drawer unit support. (order drawer unit on page 68)

Extension latérale plateau en verre, traverses en métal et support caisson (commander caisson page 68)

FLY01

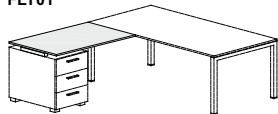

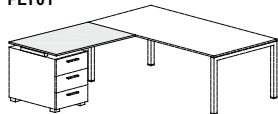
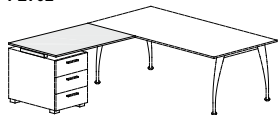
		Piano vetro / Glass worktop / Plateau en verre					
		Struttura / Structure / Structure: W - Y			Struttura / Structure / Structure: EQ		
		WV	KV		WV	KV	
MISURA	CODICE						
	80x60	55025	527,00	464,00		564,00	500,00
	100x60	55026	603,00	524,00		640,00	561,00
	80x60	55027	535,00	471,00		571,00	508,00
	100x60	55028	611,00	531,00		647,00	568,00

ELEMENTO

DESCRIZIONE

Scrivanie con piano vetro predisposte per servente portante H63 (ordinare servente monofacciale pag.69) Il disegno si riferisce alla scrivania SX

Desks with glass top predisposed for H63 bearing pedestal (order single sided pedestal on page 69). The drawing refers to the SX desk

Bureaux avec plateau en verre, pour composition avec desserte porteuse H63 (commander desserte à une seule façade page 69) Le schéma se rapporte à la composition pour bureau SX

FLY01

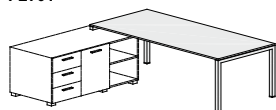

		Piano vetro / Glass worktop / Plateau en verre					
		Struttura / Structure / Structure: W - Y			Struttura / Structure / Structure: EQ		
		WV	KV		WV	KV	
MISURA	CODICE						
FLY01	140x80	DX 55030	1.047,00	901,00		1.285,00	1.139,00
		SX 55031					
	160x80	DX 55032	1.140,00	973,00		1.378,00	1.212,00
		SX 55033					
	180x80	DX 55034	1.243,00	1.056,00		1.481,00	1.294,00
		SX 55035					
	180x100	DX 55038	1.489,00	1.257,00		1.752,00	1.520,00
		SX 55039					
FLY02	200x100	DX 55040	1.604,00	1.347,00		1.867,00	1.609,00
		SX 55041					
	120x124	DX 55042	1.547,00	1.355,00		1.829,00	1.636,00
		SX 55043					
	160x164	DX 55044	2.217,00	1.881,00		2.591,00	2.255,00
		SX 55045					
	140x80	DX 55050	1.057,00	911,00		1.283,00	1.137,00
		SX 55051					
FLY02	160x80	DX 55052	1.149,00	982,00		1.374,00	1.208,00
		SX 55053					
	180x80	DX 55054	1.249,00	1.062,00		1.474,00	1.288,00
		SX 55055					
	180x100	DX 55058	1.461,00	1.228,00		1.717,00	1.485,00
		SX 55059					
	200x100	DX 55060	1.578,00	1.320,00		1.834,00	1.576,00
		SX 55061					
FLY02	120x124	DX 55062	1.522,00	1.330,00		1.787,00	1.595,00
		SX 55063					
FLY02	160x164	DX 55064	2.194,00	1.857,00		2.478,00	2.142,00
		SX 55065					

FLY 01/02/03

ELEMENTO

FLY01

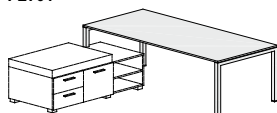

		Piano vetro / Glass worktop / Plateau en verre					
		Struttura / Structure / Structure: W - Y			Struttura / Structure / Structure: EQ		
MISURA	CODICE	WV	KV		WV	KV	
180x80	DX 55070 SX 55071	1.246,00	1.059,00		1.478,00	1.292,00	
180x100	DX 55072 SX 55073	1.490,00	1.258,00		1.744,00	1.511,00	
200x100	DX 55074 SX 55075	1.605,00	1.347,00		1.859,00	1.601,00	
160x164	DX 55078 SX 55079	2.230,00	1.894,00		2.546,00	2.210,00	

ELEMENTO

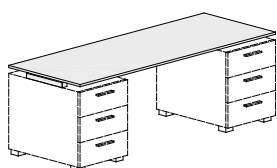

		Piano vetro / Glass worktop / Plateau en verre					
		Struttura / Structure / Structure: W - Y			Struttura / Structure / Structure: EQ		
MISURA	CODICE	WV	KV		WV	KV	
160x60	55082	911,00	787,00		985,00	860,00	
180x60	55083	988,00	847,00		1.061,00	920,00	

H72 (piani spessore 1,8)
(worktop thickness 1.8)
(épaisseur des plateaux 1,8)

Scrivanie in nobilitato
Melamine desks
Bureaux avec plateau mélaminé

ELEMENTO

DESCRIZIONE

Scrivanie con piano in nobilitato melaminico
Desk with melamine worktop
Bureau avec plateau mélaminé

FLY01

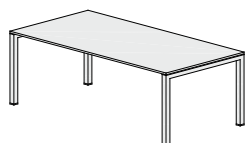

		Piano nobilitato SP.18 mm /18 mm thick melamine worktop Plateau mélaminé SP. 18 mm			
		Struttura / Structure / Structure: W - Y		Struttura / Structure / Structure: EQ	
MISURA	CODICE	G	W - RC - NA - WE	G	W - RC - NA - WE
120x60	55102	309,00	313,00	548,00	552,00
140x60	55103	316,00	320,00	556,00	560,00
160x60	55104	330,00	334,00	569,00	574,00
180x60	55105	344,00	349,00	584,00	589,00
120x80	55112	328,00	333,00	568,00	572,00
140x80	55113	340,00	345,00	580,00	585,00
160x80	55114	351,00	357,00	591,00	596,00
180x80	55115	367,00	373,00	607,00	613,00
180x100	55116	478,00	485,00	714,00	721,00
200x100	55117	495,00	503,00	732,00	740,00
120x124	55118	644,00	650,00	903,00	909,00
160x164	55119	741,00	752,00	1.085,00	1.095,00

FLY02

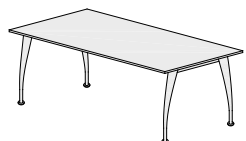

120x60	55122	313,00	317,00	536,00	540,00
140x60	55123	325,00	329,00	548,00	552,00
160x60	55124	338,00	342,00	560,00	565,00
180x60	55125	349,00	354,00	571,00	576,00
120x80	55132	333,00	337,00	567,00	571,00
140x80	55133	349,00	354,00	583,00	588,00
160x80	55134	359,00	365,00	593,00	598,00
180x80	55135	372,00	378,00	606,00	612,00
180x100	55136	415,00	422,00	685,00	692,00
200x100	55137	435,00	442,00	705,00	713,00
120x124	55138	585,00	591,00	855,00	861,00
160x164	55139	678,00	688,00	971,00	981,00

FLY 01/02/03

H73 (piani spessore 2,8)
(worktop thickness 2.8)
(épaisseur des plateaux 2,8)

Scrivanie in nobilitato
Melamine desks
Bureaux avec plateau mélaminé

ELEMENTO

DESCRIZIONE

Scrivania con piano in nobilitato melaminico
Desk with melamine worktop
Bureau avec plateau mélaminé

FLY01

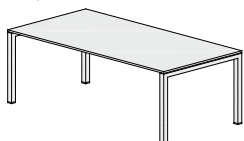

		Piano nobilitato SP.28 mm /28 mm thick melamine worktop Plateau mélaminé h. 28 mm			
		Struttura / Structure / Structure: W - Y		Struttura / Structure / Structure: EQ	
MISURA	CODICE	G	W - RC - NA - WE	G	W - RC - NA - WE
120x60	55142	316,00	323,00	555,00	562,00
140x60	55143	337,00	339,00	576,00	578,00
160x60	55144	348,00	353,00	587,00	592,00
180x60	55145	368,00	371,00	608,00	610,00
120x80	55152	349,00	351,00	588,00	590,00
140x80	55153	366,00	368,00	605,00	607,00
160x80	55154	385,00	387,00	624,00	627,00
180x80	55155	406,00	409,00	646,00	648,00
180x100	55156	513,00	516,00	750,00	753,00
200x100	55157	554,00	556,00	790,00	793,00
120x124	55158	685,00	687,00	944,00	946,00
160x164	55159	807,00	809,00	1.150,00	1.153,00

FLY02



120x60	55162	320,00	328,00	543,00	550,00
140x60	55163	346,00	348,00	568,00	570,00
160x60	55164	356,00	359,00	578,00	582,00
180x60	55165	373,00	375,00	595,00	598,00
120x80	55172	353,00	355,00	587,00	589,00
140x80	55173	375,00	377,00	609,00	611,00
160x80	55174	393,00	395,00	627,00	629,00
180x80	55175	411,00	413,00	644,00	647,00
180x100	55176	450,00	453,00	721,00	724,00
200x100	55177	493,00	495,00	763,00	766,00
120x124	55178	626,00	629,00	897,00	899,00
160x164	55179	744,00	746,00	1.037,00	1.039,00

H72 (piani spessore 1,8)
(worktop thickness 1.8)
(épaisseur des plateaux 1,8)

Scrivanie in nobilitato
Melamine desks
Bureaux avec plateau mélaminé

H73 (piani spessore 2,8)
(worktop thickness 2.8)
(épaisseur des plateaux 2,8)

ELEMENTO

DESCRIZIONE

Allungo laterale con piano in nobilitato completo di gamba cavalletto cm.60 e traverse in metallo

Return top with melamine worktop complete with 60 cm trestle leg and metal crosspieces

Extension latérale plateau mélaminé, piètement 60 cm. et traverses en métal

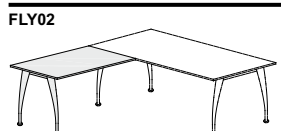
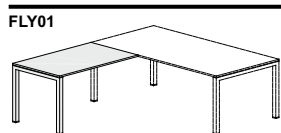

		Piano nobilitato SP.18 mm /18 mm thick melamine worktop Plateau mélaminé SP. 18 mm			
		Struttura / Structure / Structure: W - Y		Struttura / Structure / Structure: EQ	
		G	W - RC - NA - WE	G	W - RC - NA - WE
MISURA	CODICE				
80x60	55181	223,00	226,00	343,00	346,00
100x60	55182	240,00	243,00	360,00	363,00
80x60	55183	234,00	237,00	345,00	348,00
100x60	55184	252,00	255,00	364,00	367,00

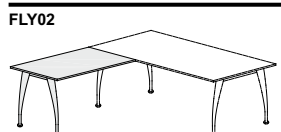
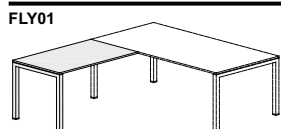

		Piano nobilitato SP.28 mm /28 mm thick melamine worktop Plateau mélaminé h. 28 mm			
		Struttura / Structure / Structure: W - Y		Struttura / Structure / Structure: EQ	
		G	W - RC - NA - WE	G	W - RC - NA - WE
MISURA	CODICE				
80x60	55185	236,00	238,00	356,00	358,00
100x60	55186	259,00	261,00	378,00	380,00
80x60	55187	247,00	249,00	358,00	360,00
100x60	55188	270,00	272,00	382,00	384,00

FLY 01/02/03

H72 (piani spessore 1,8)
(worktop thickness 1.8)
(épaisseur des plateaux 1,8)

H73 (piani spessore 2,8)
(worktop thickness 2.8)
(épaisseur des plateaux 2,8)

Scrivanie in nobilitato
Melamine desks
Bureaux avec plateau mélaminé

ELEMENTO

DESCRIZIONE

Allungo laterale con piano in nobilitato completo di traverse in metallo e supporto cassetiera. (ordinare cassetiera pag. 68)

Return top with melamine worktop complete with metal crosspieces and drawer unit support. (order drawer unit on page 68)

Extension latérale plateau mélaminé avec traverses en métal et support caisson (commander caisson page 68)

FLY01

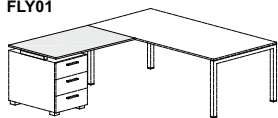

MISURA CODICE

80x60 **55191**
100x60 **55192**

Piano nobilitato SP.18 mm / 18 mm thick melamine worktop Plateau mélaminé SP. 18 mm						
Struttura / Structure / Structure: W - Y			Struttura / Structure / Structure: EQ			
G	W - RC - NA - WE		G	W - RC - NA - WE		
	80x60	55191	197,00	200,00	233,00	236,00
	100x60	55192	214,00	217,00	250,00	254,00
	80x60	55193	202,00	204,00	238,00	241,00
	100x60	55194	220,00	223,00	257,00	260,00

FLY02

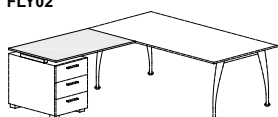

MISURA CODICE

80x60 **55193**
100x60 **55194**

FLY01

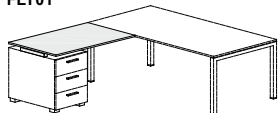

MISURA CODICE

80x60 **55195**
100x60 **55196**

Piano nobilitato SP.28 mm / 28 mm thick melamine worktop Plateau mélaminé h. 28 mm						
Struttura / Structure / Structure: W - Y			Struttura / Structure / Structure: EQ			
G	W - RC - NA - WE		G	W - RC - NA - WE		
	80x60	55195	210,00	211,00	246,00	248,00
	100x60	55196	232,00	234,00	269,00	270,00
	80x60	55197	215,00	216,00	251,00	253,00
	100x60	55198	238,00	240,00	275,00	277,00

FLY02

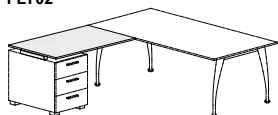

MISURA CODICE

80x60 **55197**
100x60 **55198**

H72 (piani spessore 1,8)
(worktop thickness 1.8)
(épaisseur des plateaux 1,8)

Scrivanie in nobilitato
Melamine desks
Bureaux avec plateau mélaminé

ELEMENTO

DESCRIZIONE

Scrivania con piano in nobilitato predisposta per servente portante H63 (ordinare servente monofacciale pag.69) Il disegno si riferisce alla scrivania SX

Desk with melamine top predisposed for H63 bearing pedestal (order single sided pedestal on page 69). The drawing refers to the SX desk

Bureaux avec plateau mélaminé, pour composition avec desserte porteuse H63 (commander desserte à une seule façade page 69). Le schéma se rapporte à la composition pour bureau SX

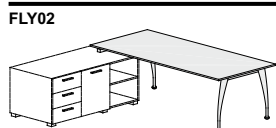
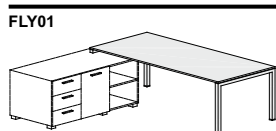

		Piano nobilitato SP.18 mm /18 mm thick melamine worktop Plateau mélaminé SP. 18 mm				
		Struttura / Structure / Structure: W - Y		Struttura / Structure / Structure: EQ		
		G	W - RC - NA - WE	G	W - RC - NA - WE	
MISURA	CODICE					
FLY01	140x80	DX 55200	339,00	344,00	577,00	582,00
		SX 55201				
	160x80	DX 55202	350,00	355,00	588,00	593,00
		SX 55203				
	180x80	DX 55204	366,00	372,00	604,00	610,00
		SX 55205				
	180x100	DX 55208	435,00	442,00	697,00	704,00
		SX 55209				
	200x100	DX 55210	453,00	460,00	715,00	723,00
		SX 55211				
	120x124	DX 55212	598,00	605,00	880,00	886,00
		SX 55213				
	160x164	DX 55214	699,00	709,00	1.073,00	1.083,00
		SX 55215				
FLY02	140x80	DX 55220	349,00	354,00	575,00	580,00
		SX 55221				
	160x80	DX 55222	359,00	364,00	585,00	590,00
		SX 55223				
	180x80	DX 55224	371,00	377,00	597,00	603,00
		SX 55225				
	180x100	DX 55228	406,00	413,00	662,00	670,00
		SX 55229				
	200x100	DX 55230	426,00	434,00	682,00	690,00
		SX 55231				
	120x124	DX 55232	574,00	580,00	838,00	844,00
		SX 55233				
	160x164	DX 55234	675,00	685,00	960,00	969,00
		SX 55235				

FLY 01/02/03

H73 (piani spessore 2,8)
(worktop thickness 2.8)
(épaisseur des plateaux 2,8)

Scrivanie in nobilitato
Melamine desks
Bureaux avec plateau mélaminé

ELEMENTO

DESCRIZIONE

Scrivania con piano in nobilitato predisposta per servente portante H63 (ordinare servente monofacciale pag.69) Il disegno si riferisce alla scrivania SX
Desk with melamine top predisposed for H63 bearing pedestal (order single sided pedestal on page 69). The drawing refers to the SX desk
Bureaux avec plateau mélaminé, pour composition avec desserte porteuse H63 (commander desserte à une seule façade page 69). Le schéma se rapporte à la composition pour bureau SX

FLY01

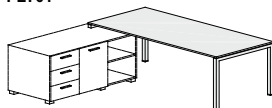

		Piano nobilitato SP28 mm /28 mm thick melamine worktop Plateau mélaminé h. 28 mm			
		Struttura / Structure / Structure: W - Y		Struttura / Structure / Structure: EQ	
MISURA	CODICE	G	W - RC - NA - WE	G	W - RC - NA - WE
140x80	DX 55240	364,00	366,00	602,00	605,00
	SX 55241				
160x80	DX 55242	383,00	386,00	622,00	624,00
	SX 55243				
180x80	DX 55244	404,00	407,00	643,00	645,00
	SX 55245				
180x100	DX 55248	471,00	473,00	733,00	736,00
	SX 55249				
200x100	DX 55250	511,00	513,00	773,00	776,00
	SX 55251				
120x124	DX 55252	640,00	643,00	921,00	924,00
	SX 55253				
160x164	DX 55254	765,00	767,00	1.139,00	1.141,00
	SX 55255				

FLY02



140x80	DX 55260	374,00	377,00	600,00	602,00
	SX 55261				
160x80	DX 55262	392,00	395,00	618,00	621,00
	SX 55263				
180x80	DX 55264	410,00	413,00	636,00	638,00
	SX 55265				
180x100	DX 55268	442,00	445,00	698,00	701,00
	SX 55269				
200x100	DX 55270	484,00	487,00	741,00	743,00
	SX 55271				
120x124	DX 55272	615,00	616,00	880,00	882,00
	SX 55273				
160x164	DX 55274	741,00	743,00	1.025,00	1.028,00
	SX 55275				

H73 (piani spessore 1,8)
 (worktop thickness 1.8)
 (épaisseur des plateaux 1,8)
 (piani spessore 2,8)
 (worktop thickness 2.8)
 (épaisseur des plateaux 2,8)

Scrivanie in nobilitato
 Melamine desks
 Bureaux avec plateau mélaminé

ELEMENTO

DESCRIZIONE

Scrivania con piano in nobilitato predisposta per servente portante H43 (ordinare servente monofacciale pag.71) Il disegno si riferisce alla scrivania SX

Desk with melamine top predisposed for H43 bearing pedestal (order single sided pedestal on page 71). The drawing refers to the SX desk

Bureaux avec plateau mélaminé, pour composition avec desserte porteuse H43 (commander desserte à une seule façade page 71). Le schéma se rapporte à la composition pour bureau SX

FLY01

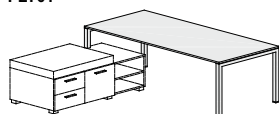

		Piano nobilitato SP18 mm /18 mm thick melamine worktop Plateau mélaminé SP. 18 mm			
		Struttura / Structure / Structure: W - Y		Struttura / Structure / Structure: EQ	
		G	W - RC - NA - WE	G	W - RC - NA - WE
MISURA	CODICE				
160x80	DX 55282	353,00	358,00	585,00	591,00
	SX 55283				
180x80	DX 55284	369,00	375,00	601,00	607,00
	SX 55285				
180x100	DX 55288	436,00	443,00	689,00	696,00
	SX 55289				
200x100	DX 55290	453,00	461,00	707,00	715,00
	SX 55291				
160x164	DX 55294	712,00	721,00	1.028,00	1.037,00
	SX 55295				

FLY01

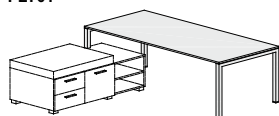

		Piano nobilitato SP28 mm /28 mm thick melamine worktop Plateau mélaminé h. 28 mm			
		Struttura / Structure / Structure: W - Y		Struttura / Structure / Structure: EQ	
		G	W - RC - NA - WE	G	W - RC - NA - WE
MISURA	CODICE				
160x80	DX 55302	387,00	389,00	619,00	621,00
	SX 55303				
180x80	DX 55304	408,00	410,00	640,00	642,00
	SX 55305				
180x100	DX 55308	471,00	474,00	725,00	728,00
	SX 55309				
200x100	DX 55310	512,00	514,00	765,00	768,00
	SX 55311				
160x164	DX 55314	777,00	780,00	1.093,00	1.096,00
	SX 55315				

FLY 01/02/03

H72 (piani spessore 1,8)
(worktop thickness 1.8)
(épaisseur des plateaux 1,8)

H73 (piani spessore 2,8)
(worktop thickness 2.8)
(épaisseur des plateaux 2,8)

Scrivanie in nobilitato
Melamine desks
Bureaux avec plateau mélaminé

ELEMENTO

DESCRIZIONE

Consolle con piano in nobilitato completo di traverse in metallo e supporti cassetiera. (ordinare cassettiere pag.68)

Console with melamine worktop complete with metal crosspieces and drawer unit supports. (order drawer unit on page 68)

Console avec plateau mélaminé muni de traverses en métal et supports caisson. (commander caisson page 68)

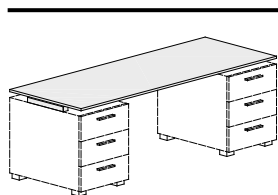

		Piano nobilitato SP.18 mm / 18 mm thick melamine worktop Plateau mélaminé SP. 18 mm			
		Struttura / Structure / Structure: W - Y		Struttura / Structure / Structure: EQ	
MISURA	CODICE	G	W - RC - NA - WE	G	W - RC - NA - WE
160x60	55322	278,00	282,00	352,00	355,00
180x60	55323	291,00	296,00	364,00	369,00

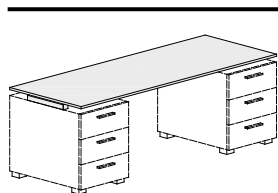

		Piano nobilitato SP.28 mm / 28 mm thick melamine worktop Plateau mélaminé h. 28 mm			
		Struttura / Structure / Structure: W - Y		Struttura / Structure / Structure: EQ	
MISURA	CODICE	G	W - RC - NA - WE	G	W - RC - NA - WE
160x60	55325	295,00	300,00	368,00	373,00
180x60	55326	313,00	316,00	387,00	389,00

H72 (piani spessore 1,8)
(worktop thickness 1.8)
(épaisseur des plateaux 1,8)

H73 (piani spessore 2,8)
(worktop thickness 2.8)
(épaisseur des plateaux 2,8)

Elementi per composizioni con struttura cavalletto
Elements for composition with trestle structure
Éléments pour compositions avec structure
piètement

ELEMENTO

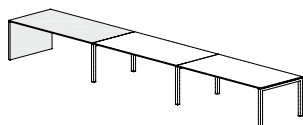

DESCRIZIONE

Tavolo INIZIALE-FINALE completo di fianco in nobilitato iniziale-finale e di traverse in metallo

N.B.: aggiungere piani e cavalletti CENTRALI

START-END table complete with start-end melamine panel and metal crosspieces.

Note: add CENTRAL worktops and trestles

Plateau DEBUT/FIN de composition équipé de piètement initial-final et de traverses en métal

NB: ajouter les plateaux et les piètements INTERMÉDIAIRES

FLY03

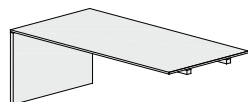

MISURA CODICE

120x60 **55664**
140x60 **55665**
160x60 **55666**
180x60 **55667**
120x80 **55668**
140x80 **55669**
160x80 **55670**
180x80 **55671**

Piano nobilitato SP.18 mm / 18 mm thick melamine worktop Plateau mélaminé SP. 18 mm			
G	W - RC - NA - WE		
	248,00	254,00	
	255,00	261,00	
	269,00	275,00	
	284,00	290,00	
	267,00	273,00	
	279,00	286,00	
	290,00	297,00	
	306,00	314,00	

FLY03

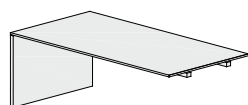

MISURA CODICE

120x60 **55672**
140x60 **55673**
160x60 **55674**
180x60 **55675**
120x80 **55676**
140x80 **55677**
160x80 **55678**
180x80 **55679**

Piano nobilitato SP.28 mm / 28 mm thick melamine worktop Plateau mélaminé h. 28 mm			
G	W - RC - NA - WE		
	255,00	264,00	
	276,00	280,00	
	287,00	294,00	
	307,00	312,00	
	287,00	291,00	
	304,00	308,00	
	324,00	328,00	
	345,00	349,00	

FLY 01/02/03

H72 (piani spessore 1,8)
(worktop thickness 1.8)
(épaisseur des plateaux 1,8)

Elementi per composizioni con struttura cavalletto
Elements for composition with trestle structure
Éléments pour compositions avec structure
piètement

ELEMENTO

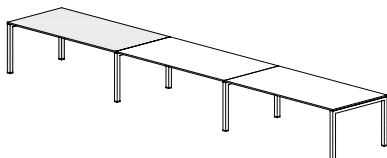

DESCRIZIONE

Tavolo INIZIALE-FINALE completo di cavalletto iniziale-finale e di traverse in metallo.

N.B.: aggiungere piani e cavalletti CENTRALI

START-END table complete with start-end trestle predisposed for metal crosspieces.

Note: add CENTRAL worktops and trestles

Plateau DEBUT/FIN de composition équipé de piètement initial-final et de traverses en métal.

NB: ajouter les plateaux et les piètements INTERMÉDIAIRES

FLY01

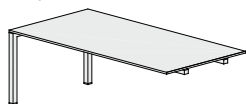

FLY02

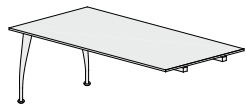

		Piano nobilitato SP.18 mm / 18 mm thick melamine worktop Plateau mélaminé SP. 18 mm			
		Struttura / Structure / Structure: W - Y		Struttura / Structure / Structure: EQ	
		G	W - RC - NA - WE	G	W - RC - NA - WE
MISURA	CODICE				
120x60	55332	223,00	226,00	343,00	346,00
140x60	55333	230,00	234,00	350,00	354,00
160x60	55334	244,00	248,00	364,00	368,00
180x60	55335	258,00	263,00	378,00	383,00
120x80	55342	237,00	241,00	357,00	361,00
140x80	55343	249,00	254,00	369,00	374,00
160x80	55344	260,00	265,00	379,00	385,00
180x80	55345	276,00	282,00	396,00	402,00
180x100	55346	337,00	344,00	455,00	462,00
200x100	55347	355,00	362,00	473,00	481,00
120x60	55352	222,00	225,00	333,00	337,00
140x60	55353	233,00	238,00	345,00	349,00
160x60	55354	246,00	250,00	357,00	362,00
180x60	55355	257,00	262,00	369,00	374,00
120x80	55362	253,00	240,00	353,00	357,00
140x80	55363	252,00	257,00	369,00	374,00
160x80	55364	262,00	267,00	379,00	384,00
180x80	55365	274,00	281,00	392,00	398,00
180x100	55366	302,00	309,00	437,00	444,00
200x100	55367	322,00	330,00	457,00	465,00

H73 (piani spessore 2,8)
(worktop thickness 2.8)
(épaisseur des plateaux 2,8)

Elementi per composizioni con struttura cavalletto
Elements for composition with trestle structure
Éléments pour compositions avec structure
piètement

ELEMENTO

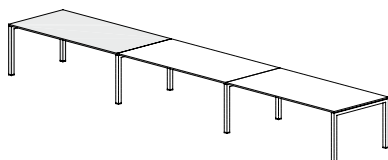

DESCRIZIONE

Tavolo INIZIALE-FINALE completo di cavalletto iniziale-finale e di traverse in metallo.

N.B.: aggiungere piani e cavalletti CENTRALI

START-END table complete with start-end trestle predisposed for metal crosspieces.

Note: add CENTRAL worktop and trestles

Plateau DEBUT/FIN de composition équipé de piètement initial-final et de traverses en métal.

NB: ajouter les plateaux et les piètements INTERMÉDIAIRES

FLY01

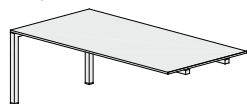

FLY02

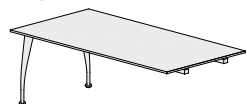

		Piano nobilitato SP.28 mm /28 mm thick melamine worktop Plateau mélaminé h. 28 mm			
		Struttura / Structure / Structure: W - Y		Struttura / Structure / Structure: EQ	
MISURA	CODICE	G	W - RC - NA - WE	G	W - RC - NA - WE
120x60	55372	230,00	237,00	350,00	357,00
140x60	55373	250,00	253,00	370,00	373,00
160x60	55374	262,00	267,00	382,00	387,00
180x60	55375	282,00	285,00	402,00	405,00
120x80	55382	257,00	259,00	377,00	379,00
140x80	55383	274,00	276,00	394,00	396,00
160x80	55384	293,00	296,00	413,00	416,00
180x80	55385	314,00	318,00	434,00	438,00
180x100	55386	373,00	375,00	491,00	493,00
200x100	55387	413,00	415,00	531,00	533,00
120x60	55392	228,00	236,00	340,00	347,00
140x60	55393	254,00	256,00	365,00	368,00
160x60	55394	264,00	269,00	375,00	380,00
180x60	55395	281,00	283,00	392,00	395,00
120x80	55402	256,00	258,00	373,00	375,00
140x80	55403	277,00	280,00	395,00	397,00
160x80	55404	296,00	298,00	413,00	415,00
180x80	55405	313,00	316,00	430,00	433,00
180x100	55406	338,00	341,00	473,00	476,00
200x100	55407	380,00	383,00	515,00	518,00

FLY 01/02/03

H72 (piani spessore 1,8)
(worktop thickness 1.8)
(épaisseur des plateaux 1,8)

Elementi per composizioni con struttura cavalletto
Elements for composition with trestle structure
Éléments pour compositions avec structure
piètement

ELEMENTO

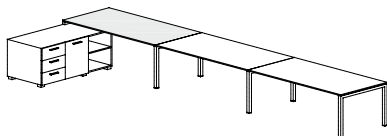

DESCRIZIONE

Tavolo INIZIALE-FINALE completo di cavalletto iniziale-finale predisposto per servente portante H63 e di traverse in metallo. (ordinare servente monofacciale pag. 69) Il disegno si riferisce al tavolo SX. N.B.: aggiungere piani e cavalletti CENTRALI
START-END table complete with start-end trestle predisposed for H63 bearing pedestal and metal crosspieces. (order single sided pedestal on page 69). The drawing refers to the SX table. Note: add CENTRAL worktops and trestles
Plan DEBUT/FIN de composition équipé de piètement initial-final pour montage d'une desserte porteuse H43 et de traverses en métal. (commander desserte à une seule façade page 69) Le schéma se rapporte à la composition pour bureau SX
NB: ajouter les plateaux et les piètements INTERMÉDIAIRES

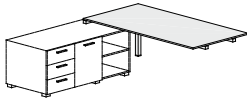
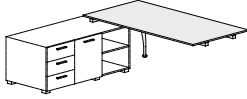
		Piano nobilitato SP18 mm /18 mm thick melamine worktop Plateau mélaminé SP. 18 mm						
		Struttura / Structure / Structure: W - Y			Struttura / Structure / Structure: EQ			
		G	W - RC - NA - WE		G	W - RC - NA - WE		
MISURA	CODICE							
FLY01 	120x60	DX 55412 SX 55413	210,00	214,00	334,00	338,00		
	140x60	DX 55414 SX 55415	218,00	222,00	342,00	346,00		
	160x60	DX 55416 SX 55417	231,00	236,00	355,00	360,00		
	180x60	DX 55418 SX 55419	246,00	251,00	370,00	375,00		
	120x80	DX 55422 SX 55423	230,00	234,00	348,00	352,00		
	140x80	DX 55424 SX 55425	242,00	247,00	360,00	365,00		
	160x80	DX 55426 SX 55427	253,00	258,00	371,00	379,00		
	180x80	DX 55428 SX 55429	269,00	275,00	387,00	393,00		
	180x100	DX 55430 SX 55431	288,00	295,00	433,00	440,00		
	200x100	DX 55432 SX 55433	306,00	314,00	450,00	458,00		
	FLY02 	120x60	DX 55442 SX 55443	212,00	216,00	313,00	317,00	
		140x60	DX 55444 SX 55445	224,00	228,00	325,00	329,00	
		160x60	DX 55446 SX 55447	236,00	241,00	338,00	342,00	
		180x60	DX 55448 SX 55449	248,00	253,00	349,00	354,00	
120x80		DX 55452 SX 55453	230,00	234,00	339,00	343,00		
140x80		DX 55454 SX 55455	246,00	251,00	355,00	360,00		
160x80		DX 55456 SX 55457	256,00	262,00	365,00	370,00		
180x80		DX 55458 SX 55459	269,00	275,00	377,00	383,00		
180x100		DX 55460 SX 55461	288,00	295,00	409,00	416,00		
200x100		DX 55462 SX 55463	308,00	316,00	429,00	437,00		

H73 (piani spessore 2,8)
(worktop thickness 2.8)
(épaisseur des plateaux 2,8)

Elementi per composizioni con struttura cavalletto
Elements for composition with trestle structure
Éléments pour compositions avec structure
piètement

ELEMENTO

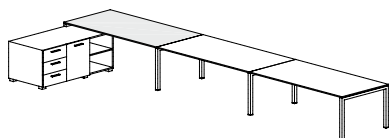

DESCRIZIONE

Tavolo INIZIALE-FINALE completo di cavalletto iniziale-finale predisposto per servente portante H63 e di traverse in metallo. (ordinare servente monofacciale pag. 69) Il disegno si riferisce al tavolo SX. N.B.: aggiungere piani e cavalletti CENTRALI
START-END table complete with start-end trestle predisposed for H63 bearing pedestal and metal crosspieces. (order single sided pedestal on page 69). The drawing refers to the SX table. Note: add CENTRAL worktops and trestles
Plan DEBUT/FIN de composition équipé de piètement initial-final pour montage d'une desserte porteuse H43 et de traverses en métal. (commander desserte à une seule façade page 69) Le schéma se rapporte à la composition pour bureau SX
NB: ajouter les plateaux et les piètements INTERMÉDIAIRES

FLY01

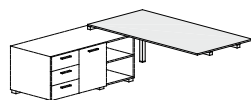

		Piano nobilitato SP 28 mm /28 mm thick melamine worktop Plateau mélaminé SP. 28 mm				
		Struttura / Structure / Structure: W - Y		Struttura / Structure / Structure: EQ		
MISURA	CODICE	G	W - RC - NA - WE	G	W - RC - NA - WE	
120x60	DX 55472	217,00	225,00	341,00	348,00	
	SX 55473					
	140x60	DX 55474	238,00	240,00	362,00	364,00
		SX 55475				
	160x60	DX 55476	249,00	254,00	373,00	378,00
		SX 55477				
	180x60	DX 55478	270,00	272,00	394,00	396,00
		SX 55479				
	120x80	DX 55482	250,00	252,00	368,00	371,00
		SX 55483				
140x80	DX 55484	267,00	269,00	386,00	388,00	
	SX 55485					
160x80	DX 55486	287,00	289,00	405,00	407,00	
	SX 55487					
180x80	DX 55488	308,00	310,00	426,00	428,00	
	SX 55489					
180x100	DX 55490	324,00	327,00	468,00	471,00	
	SX 55491					
200x100	DX 55492	364,00	367,00	509,00	511,00	
	SX 55493					
120x60	DX 55502	219,00	226,00	320,00	328,00	
	SX 55503					
	140x60	DX 55504	244,00	247,00	346,00	348,00
		SX 55505				
	160x60	DX 55506	254,00	259,00	356,00	361,00
		SX 55507				
	180x60	DX 55508	271,00	274,00	373,00	375,00
		SX 55509				
	120x80	DX 55512	250,00	252,00	359,00	361,00
		SX 55513				
140x80	DX 55514	272,00	274,00	381,00	383,00	
	SX 55515					
160x80	DX 55516	290,00	292,00	399,00	401,00	
	SX 55517					
180x80	DX 55518	308,00	310,00	416,00	419,00	
	SX 55519					
180x100	DX 55520	324,00	326,00	446,00	448,00	
	SX 55521					
200x100	DX 55522	366,00	368,00	487,00	490,00	
	SX 55523					

FLY02

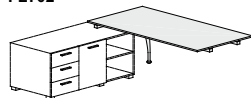

FLY 01/02/03

H72 (piani spessore 1,8)
(worktop thickness 1.8)
(épaisseur des plateaux 1,8)

H73 (piani spessore 2,8)
(worktop thickness 2.8)
(épaisseur des plateaux 2,8)

Elementi per composizioni con struttura cavalletto
Elements for composition with trestle structure
Éléments pour compositions avec structure
piètement

ELEMENTO

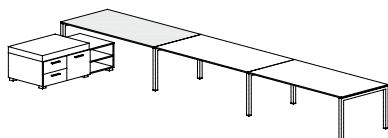

DESCRIZIONE

Tavolo INIZIALE-FINALE completo di cavalletto iniziale-finale predisposto per servente portante H43 e di traverse in metallo. (ordinare servente monofacciale pag.71) Il disegno si riferisce al tavolo SX.

N.B.: aggiungere piani e cavalletti CENTRALI

START-END table complete with start-end trestle predisposed for H43 bearing pedestal and metal crosspieces. (order single sided pedestal on page 71). The drawing refers to the SX table.

Note: add CENTRAL worktops and trestles

Plan DEBUT/FIN de composition équipé de piètement initial-final pour montage d'une desserte porteuse H43 et de traverses en métal. (commander desserte à une seule façade page 71) Le schéma se rapporte à la composition pour bureau SX.

NB: ajouter les plateaux et les piètements INTERMÉDIAIRES

FLY01

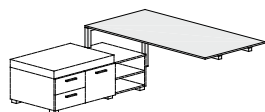

		Piano nobilitato SP18 mm /18 mm thick melamine worktop Plateau mélaminé SP. 18 mm			
		Struttura / Structure / Structure: W - Y		Struttura / Structure / Structure: EQ	
		G	W - RC - NA - WE	G	W - RC - NA - WE
MISURA	CODICE				
160x60	DX 55536	238,00	242,00	340,00	344,00
	SX 55537				
180x60	DX 55538	253,00	258,00	354,00	359,00
	SX 55539				
160x80	DX 55546	256,00	261,00	368,00	374,00
	SX 55547				
180x80	DX 55548	272,00	278,00	384,00	390,00
	SX 55549				
180x100	DX 55550	289,00	296,00	424,00	432,00
	SX 55551				
200x100	DX 55552	307,00	315,00	442,00	450,00
	SX 55553				

FLY01

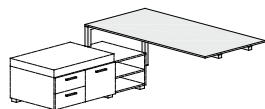

		Piano nobilitato SP28 mm /28 mm thick melamine worktop Plateau mélaminé h. 28 mm			
		Struttura / Structure / Structure: W - Y		Struttura / Structure / Structure: EQ	
		G	W - RC - NA - WE	G	W - RC - NA - WE
MISURA	CODICE				
160x60	DX 55566	256,00	261,00	358,00	363,00
	SX 55567				
180x60	DX 55568	276,00	279,00	378,00	381,00
	SX 55569				
160x80	DX 55576	290,00	292,00	402,00	404,00
	SX 55577				
180x80	DX 55578	311,00	313,00	423,00	426,00
	SX 55579				
180x100	DX 55580	325,00	328,00	460,00	463,00
	SX 55581				
200x100	DX 55582	365,00	368,00	501,00	503,00
	SX 55583				

H72 (piani spessore 1,8)
(worktop thickness 1.8)
(épaisseur des plateaux 1,8)

H73 (piani spessore 2,8)
(worktop thickness 2.8)
(épaisseur des plateaux 2,8)

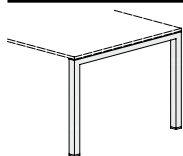

Elementi per composizioni con struttura cavalletto
Elements for composition with trestle structure
Éléments pour compositions avec structure
piètement

ELEMENTO



DESCRIZIONE

Cavalletto terminale per scrivanie con piani singoli
End trestle for desks with single worktop
Piètement terminal pour bureaux à plateaux individuels

		MISURA	CODICE
FLY01 	SINGOLA SINGLE SIMPLE	60	55585
		80	55586
		100	55587
FLY02 	SINGOLA SINGLE SIMPLE	60	55591
		80	55592
		100	55593

Metallo / Metal / Métal					
W	Y	EQ			
91,00	91,00	211,00			
97,00	97,00	217,00			
146,00	146,00	266,00			
97,00	97,00	208,00			
103,00	103,00	220,00			
118,00	118,00	253,00			

ELEMENTO

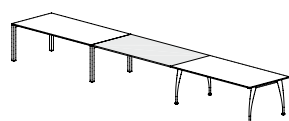

DESCRIZIONE

Piano CENTRALE completo di traverse in metallo
CENTRAL worktop complete with metal crosspieces
Plateau CENTRAL avec traverses en métal

	MISURA	CODICE
FLY01 - FLY02 - FLY03 	120x60	55602
	140x60	55603
	160x60	55604
	180x60	55605
	120x80	55612
	140x80	55613
	160x80	55614
	180x80	55615
	180x100	55616
	200x100	55617

Piano nobilitato SP.18 mm / 18 mm thick melamine worktop Plateau mélaminé SP. 18 mm		
G	W - RC - NA - WE	
	132,00	135,00
	139,00	143,00
	152,00	157,00
	167,00	172,00
	140,00	144,00
	152,00	157,00
	163,00	168,00
	179,00	185,00
	190,00	198,00
	208,00	216,00

	MISURA	CODICE
FLY01 - FLY02 - FLY03 	120x60	55622
	140x60	55623
	160x60	55624
	180x60	55625
	120x80	55632
	140x80	55633
	160x80	55634
	180x80	55635
	180x100	55636
	200x100	55637

Piano nobilitato SP.28 mm / 28 mm thick melamine worktop Plateau mélaminé h. 28 mm		
G	W - RC - NA - WE	
	138,00	146,00
	159,00	161,00
	170,00	175,00
	191,00	193,00
	160,00	162,00
	177,00	179,00
	196,00	199,00
	218,00	220,00
	226,00	229,00
	266,00	269,00

FLY 01/02/03

H72 (piani spessore 1,8)
(worktop thickness 1.8)
(épaisseur des plateaux 1,8)

H73 (piani spessore 2,8)
(worktop thickness 2.8)
(épaisseur des plateaux 2,8)

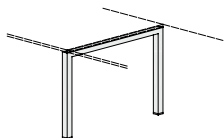

Elementi per composizioni con struttura cavalletto
Elements for composition with trestle structure
Éléments pour compositions avec structure
piètement

ELEMENTO

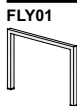

DESCRIZIONE

Cavalletto centrale per scrivanie con piani singoli
Central trestle for desks with single worktop
Piètement central pour bureaux à plateaux individuels

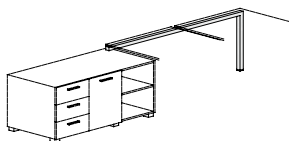

		MISURA	CODICE	Metallo / Metal / Métal			
				W	Y	EQ	
FLY01 	SINGOLA SINGLE SIMPLE	60	55641	118,00	118,00	207,00	
		80	55642	127,00	127,00	216,00	
		100	55643	135,00	135,00	229,00	
FLY02 	SINGOLA SINGLE SIMPLE	60	55645	123,00	123,00	222,00	
		80	55646	132,00	132,00	230,00	
		100	55647	140,00	140,00	242,00	

ELEMENTO



DESCRIZIONE

Cavalletto centrale per scrivanie con piani singoli predisposte per servente portante H63. N.b.: utilizzare serventi monofacciali o bifacciali
Central trestle for desks with single worktop predisposed for H63 bearing pedestal.
Note: use single or double sided pedestals
Piètement central pour bureaux à plateaux individuels pour desserte porteuse H63.
Nb: utiliser dessertes à une ou a deux façades

		MISURA	CODICE	Metallo / Metal / Métal			
				W	Y	EQ	
FLY01 	SINGOLA SINGLE SIMPLE	60	55651	106,00	106,00	217,00	
		80	55652	113,00	113,00	255,00	
		100	55653	122,00	122,00	274,00	
FLY02 	SINGOLA SINGLE SIMPLE	60	55655	113,00	113,00	211,00	
		80	55656	119,00	119,00	230,00	
		100	55657	130,00	130,00	258,00	

ELEMENTO

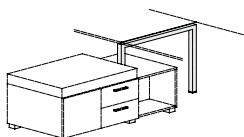

DESCRIZIONE

Cavalletto centrale per scrivanie con piani singoli predisposte per servente portante H43. N.b.: utilizzare serventi monofacciali o bifacciali
Central trestle for desks with single worktop predisposed for H43 bearing pedestal.
Note: use single or double sided pedestals
Piètement central pour les bureaux à plateaux individuels pour composition avec
desserte porteuse H43. Nb: utiliser dessertes à une ou à deux façades

		MISURA	CODICE	Metallo / Metal / Métal			
				W	Y	EQ	
FLY01 	SINGOLA SINGLE SIMPLE	60	55661	104,00	104,00	204,00	
		80	55662	123,00	123,00	252,00	
		100	55663	129,00	129,00	270,00	

H72 (piani spessore 1,8)
(worktop thickness 1.8)
(épaisseur des plateaux 1,8)

H73 (piani spessore 2,8)
(worktop thickness 2.8)
(épaisseur des plateaux 2,8)

Elementi per composizioni con struttura cavalletto
Elements for composition with trestle structure
Éléments pour compositions avec structure
piètement

ELEMENTO

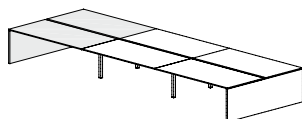

DESCRIZIONE

Tavoli contrapposti INIZIALE-FINALE completi di fianco in nobilitato iniziale-finale e di traverse in metallo. N.B.: aggiungere piani e cavalletti CENTRALI

Opposing START-END tables complete with start-end trestle and metal crosspieces.

Note: add CENTRAL worktops and trestles

Bureaux DÉBUT-FIN de composition avec parement début-fin en mélaminé et traverses en métal. NB: ajouter les plateaux et les piètements INTERMÉDIAIRES

FLY03

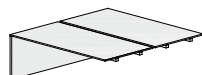

		Piano nobilitato SP.18 mm /18 mm thick melamine worktop Plateau mélaminé SP. 18 mm			
MISURA	CODICE	G	W - RC - NA - WE		
120x124	55681	428,00	438,00		
140x124	55682	442,00	453,00		
160x124	55683	470,00	481,00		
180x124	55684	499,00	512,00		
120x164	55686	456,00	468,00		
140x164	55687	480,00	493,00		
160x164	55688	501,00	516,00		
180x164	55689	533,00	549,00		

FLY03

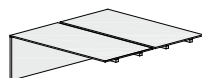

		Piano nobilitato SP.28 mm /28 mm thick melamine worktop Plateau mélaminé h. 28 mm			
MISURA	CODICE	G	W - RC - NA - WE		
120x124	55691	442,00	459,00		
140x124	55692	483,00	491,00		
160x124	55693	506,00	518,00		
180x124	55694	546,00	554,00		
120x164	55696	496,00	504,00		
140x164	55697	531,00	538,00		
160x164	55698	569,00	577,00		
180x164	55699	611,00	619,00		

FLY 01/02/03

H72 (piani spessore 1,8)
(worktop thickness 1.8)
(épaisseur des plateaux 1,8)

Elementi per composizioni con struttura cavalletto
Elements for composition with trestle structure
Éléments pour compositions avec structure
piètement

ELEMENTO

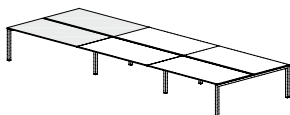

DESCRIZIONE

Tavoli contrapposti INIZIALE-FINALE completi di cavalletto iniziale-finale e di traverse in metallo.

N.B.: aggiungere piani e cavalletti CENTRALI oppure cavalletti TERMINALI

Opposing START-END tables complete with start-end trestle and metal crosspieces.

Note: add CENTRAL worktops and trestles or END trestles

Bureaux face-à-face DÉBUT-FIN de composition équipé de piètement initial-final et de traverses en métal

NB: ajouter des plateaux et des piètements INTERMÉDIAIRES ou des piètements TERMINAUX

FLY01



FLY02



		Piano nobilitato SP.18 mm / 18 mm thick melamine worktop Plateau mélaminé SP. 18 mm				
		Struttura / Structure / Structure: W - Y		Struttura / Structure / Structure: EQ		
MISURA	CODICE	G	W - RC - NA - WE	G	W - RC - NA - WE	
FLY01	120x124	55702	438,00	445,00	567,00	574,00
	140x124	55703	452,00	460,00	582,00	590,00
	160x124	55704	479,00	488,00	609,00	618,00
	180x124	55705	509,00	518,00	638,00	648,00
	120x164	55712	465,00	474,00	638,00	647,00
	140x164	55713	489,00	499,00	662,00	672,00
	160x164	55714	511,00	522,00	684,00	695,00
	180x164	55715	543,00	555,00	716,00	728,00
FLY02	120x124	55722	402,00	409,00	537,00	544,00
	140x124	55723	425,00	433,00	560,00	568,00
	160x124	55724	450,00	459,00	585,00	594,00
	180x124	55725	473,00	482,00	608,00	617,00
	120x164	55732	424,00	432,00	570,00	579,00
	140x164	55733	457,00	466,00	603,00	613,00
	160x164	55734	476,00	487,00	623,00	633,00
	180x164	55735	502,00	514,00	648,00	660,00

H73 (piani spessore 2,8)
(worktop thickness 2.8)
(épaisseur des plateaux 2,8)

Elementi per composizioni con struttura cavalletto
Elements for composition with trestle structure
Éléments pour compositions avec structure
piètement

ELEMENTO

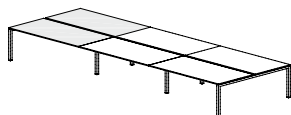

DESCRIZIONE

Tavoli contrapposti INIZIALE-FINALE completi di cavalletto iniziale-finale e di traverse in metallo.

N.B.: aggiungere piani e cavalletti CENTRALI oppure cavalletti TERMINALI

Opposing START-END tables complete with start-end trestle and metal crosspieces.

Note: add CENTRAL worktops and trestles or END trestles

Bureaux face-à-face DÉBUT-FIN de composition équipé de piètement initial-final et de traverses en métal

NB: ajouter des plateaux et des piètements INTERMÉDIAIRES ou des piètements TERMINAUX

FLY01

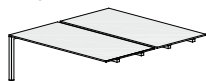

FLY02

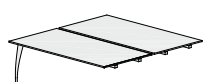

		Piano nobilitato SP.28 mm /28 mm thick melamine worktop Plateau mélaminé h. 28 mm			
		Struttura / Structure / Structure: W - Y		Struttura / Structure / Structure: EQ	
		G	W - RC - NA - WE	G	W - RC - NA - WE
MISURA	CODICE				
120x124	55742	451,00	466,00	581,00	595,00
140x124	55743	493,00	498,00	623,00	627,00
160x124	55744	515,00	525,00	645,00	655,00
180x124	55745	556,00	561,00	686,00	691,00
120x164	55752	506,00	510,00	679,00	683,00
140x164	55753	540,00	545,00	713,00	718,00
160x164	55754	579,00	583,00	752,00	756,00
180x164	55755	621,00	626,00	794,00	799,00
120x124	55762	415,00	430,00	550,00	565,00
140x124	55763	466,00	471,00	601,00	606,00
160x124	55764	486,00	496,00	621,00	631,00
180x124	55765	520,00	525,00	655,00	660,00
120x164	55772	464,00	468,00	611,00	615,00
140x164	55773	508,00	512,00	654,00	658,00
160x164	55774	544,00	548,00	690,00	695,00
180x164	55775	579,00	584,00	726,00	730,00

FLY 01/02/03

H72 (piani spessore 1,8)
(worktop thickness 1.8)
(épaisseur des plateaux 1,8)

H73 (piani spessore 2,8)
(worktop thickness 2.8)
(épaisseur des plateaux 2,8)

Elementi per composizioni con struttura cavalletto
Elements for composition with trestle structure
Éléments pour compositions avec structure
piètement

ELEMENTO

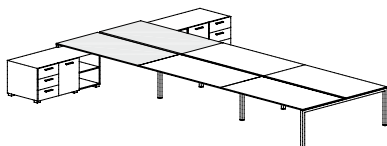

DESCRIZIONE

Tavoli contrapposti INIZIALE-FINALE completi di cavalletto iniziale-finale predisposti per 2 servente portanti H63 (ordinare servente monofacciale pag. 69) e di traverse in metallo.

N.B.: aggiungere piani e cavalletti CENTRALI

Opposing START-END tables complete with start-end trestle predisposed for 2 H63 bearing pedestals (order single sided pedestal on page 69) and metal crosspieces.
Note: add CENTRAL worktops and trestles

Bureaux face-à-face DÉBUT-FIN de composition avec piètement initial-final pour 2 dessertes porteuses H63 (commander desserte à une seule façade page 69) et traverses en métal.

NB: ajouter les plateaux et les piètements INTERMÉDIAIRES

FLY01 - FLY02

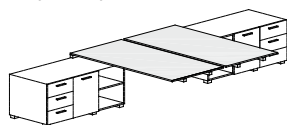

		Piano nobilitato SP.18 mm / 18 mm thick melamine worktop Plateau mélaminé SP. 18 mm			
		Struttura / Structure / Structure: W - Y		Struttura / Structure / Structure: EQ	
		G	W - RC - NA - WE	G	W - RC - NA - WE
MISURA	CODICE				
120x124	55802	356,00	363,00	404,00	411,00
140x124	55803	370,00	378,00	418,00	426,00
160x124	55804	398,00	407,00	445,00	455,00
180x124	55805	427,00	437,00	475,00	485,00
120x164	55812	386,00	395,00	434,00	443,00
140x164	55813	410,00	420,00	458,00	468,00
160x164	55814	432,00	443,00	480,00	491,00
180x164	55815	464,00	476,00	512,00	524,00

FLY01 - FLY02

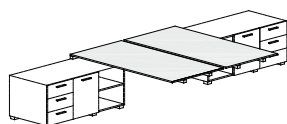

		Piano nobilitato SP.28 mm / 28 mm thick melamine worktop Plateau mélaminé h. 28 mm			
		Struttura / Structure / Structure: W - Y		Struttura / Structure / Structure: EQ	
		G	W - RC - NA - WE	G	W - RC - NA - WE
MISURA	CODICE				
120x124	55842	370,00	384,00	418,00	432,00
140x124	55843	411,00	416,00	459,00	464,00
160x124	55844	434,00	444,00	482,00	491,00
180x124	55845	474,00	480,00	522,00	527,00
120x164	55852	427,00	431,00	475,00	479,00
140x164	55853	461,00	466,00	509,00	514,00
160x164	55854	500,00	504,00	548,00	552,00
180x164	55855	542,00	547,00	590,00	595,00

H72 (piani spessore 1,8)
(worktop thickness 1.8)
(épaisseur des plateaux 1,8)

H73 (piani spessore 2,8)
(worktop thickness 2.8)
(épaisseur des plateaux 2,8)

ELEMENTO

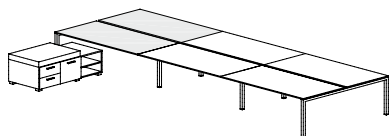

FLY01

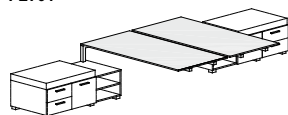

MISURA CODICE

		Piano nobilitato SP.18 mm / 18 mm thick melamine worktop Plateau mélaminé SP. 18 mm			
		Struttura / Structure / Structure: W - Y		Struttura / Structure / Structure: EQ	
		G	W - RC - NA - WE	G	W - RC - NA - WE
160x124	55884	437,00	446,00	499,00	508,00
180x124	55885	466,00	476,00	529,00	539,00
160x164	55887	482,00	493,00	576,00	587,00
180x164	55888	514,00	526,00	608,00	620,00

FLY01

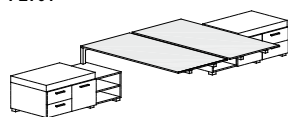

MISURA CODICE

		Piano nobilitato SP.28 mm / 28 mm thick melamine worktop Plateau mélaminé h. 28 mm			
		Struttura / Structure / Structure: W - Y		Struttura / Structure / Structure: EQ	
		G	W - RC - NA - WE	G	W - RC - NA - WE
160x124	55894	473,00	483,00	535,00	545,00
180x124	55895	514,00	519,00	576,00	581,00
160x164	55897	549,00	554,00	643,00	648,00
180x164	55898	592,00	596,00	686,00	690,00

ELEMENTO

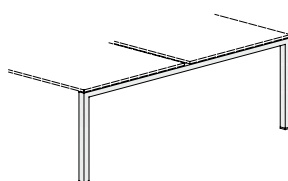

FLY01



SINGOLA
SINGLE
SIMPLE

MISURA CODICE

		Metallo / Metal / Métal			
		W	Y	EQ	
124	56021	175,00	175,00	304,00	
164	56022	186,00	186,00	359,00	

FLY02



SINGOLA
SINGLE
SIMPLE

MISURA CODICE

124	56024	152,00	152,00	287,00	
164	56025	158,00	158,00	304,00	

Elementi per composizioni con struttura cavalletto
Elements for composition with trestle structure
Éléments pour compositions avec structure
piètement

DESCRIZIONE

Tavoli contrapposti INIZIALE-FINALE completi di cavalletto iniziale-finale predisposti per 2 servente portanti H43 (ordinare servente monofacciale pag.71) e di traverse in metallo. N.B.: aggiungere piani e cavalletti CENTRALI

Opposing START-END tables complete with start-end trestle predisposed for 2 H43 bearing pedestals (order single sided pedestal on page 71) and metal crosspieces. Note: add CENTRAL worktops and trestles

Bureaux face-à-face DÉBUT-FIN de composition avec piètement initial-final pour 2 dessertes porteuses H43 (commander desserte à une seule façade page 71) et traverses en métal. NB: ajouter les plateaux et les piètements INTERMÉDIAIRES

H72 (piani spessore 1,8)
 (worktop thickness 1.8)
 (épaisseur des plateaux 1,8)

H73 (piani spessore 2,8)
 (worktop thickness 2.8)
 (épaisseur des plateaux 2,8)

Elementi per composizioni con struttura cavalletto
 Elements for composition with trestle structure
 Éléments pour compositions avec structure
 piètement

ELEMENTO

DESCRIZIONE

Fianco nobilitato terminale per scrivanie con piani contrapposti
 Melamine end panel leg for desks with opposing worktops
 Parement terminal en mélaminé pour bureaux à plateaux face-à-face

FLY03

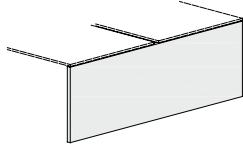

		Fianco nobilitato SP.28 mm /28 mm thick panel leg Parement mélaminé h. 28 mm			
MISURA	CODICE	G	W - RC - NA - WE		
124	56027	165,00	168,00		
164	56028	176,00	179,00		

H72 (piani spessore 1,8)
(worktop thickness 1.8)
(épaisseur des plateaux 1,8)

H73 (piani spessore 2,8)
(worktop thickness 2.8)
(épaisseur des plateaux 2,8)

Elementi per composizioni con struttura cavalletto
Elements for composition with trestle structure
Éléments pour compositions avec structure
piètement

ELEMENTO

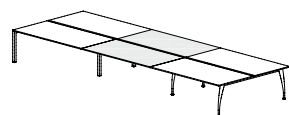

FLY01 - FLY02 - FLY03



MISURA CODICE

120x124	55912
140x124	55913
160x124	55914
180x124	55915
120x164	55922
140x164	55923
160x164	55924
180x164	55925

DESCRIZIONE

Piani contrapposti CENTRALE completi di traverse in metallo
Opposing CENTRAL worktops complete with metal crosspieces
Plateaux face-à-face INTERMÉDIAIRES avec traverses en métal

Piano nobilitato SP.18 mm /18 mm thick melamine worktop
Plateau mélaminé SP. 18 mm

G	W - RC - NA - WE		

FLY01 - FLY02 - FLY03



MISURA CODICE

120x124	55932
140x124	55933
160x124	55934
180x124	55935
120x164	55942
140x164	55943
160x164	55944
180x164	55945

Piano nobilitato SP.28 mm /28 mm thick melamine worktop
Plateau mélaminé h. 28 mm

G	W - RC - NA - WE		

ELEMENTO

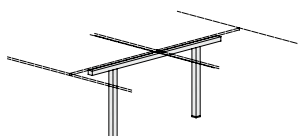

FLY01



SINGOLA
SINGLE
SIMPLE

MISURA CODICE

124	56091
164	56092

FLY02



SINGOLA
SINGLE
SIMPLE

124	56094
164	56095

DESCRIZIONE

Cavalletto centrale per scrivanie con piani contrapposti
Central trestle for desks with opposing worktops
Piètement intermédiaire pour bureaux face-à-face

Metallo / Metal / Métal

W	Y	EQ		

H72 (piani spessore 1,8)
(worktop thickness 1.8)
(épaisseur des plateaux 1,8)

H73 (piani spessore 2,8)
(worktop thickness 2.8)
(épaisseur des plateaux 2,8)

Elementi per composizioni con struttura cavalletto
Elements for composition with trestle structure
Éléments pour compositions avec structure
piètement

ELEMENTO

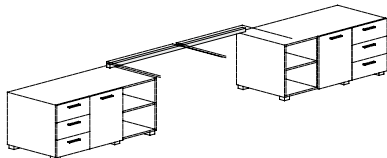

DESCRIZIONE

Cavalletto centrale per scrivanie con piani contrapposti predisposte per 2 serventi portanti H63. N.b.: utilizzare serventi monofacciali o bifacciali

Central trestle for desks with opposing worktops predisposed for 2 H63 bearing pedestals. Note: use single or double sided pedestals

Piètement intermédiaire de bureaux face-à-face pour 2 dessertes porteuses H63
Nb: utiliser dessertes à une ou à deux façades

		MISURA	CODICE					
FLY01 - FLY02	SINGOLA SINGLE SIMPLE	124	56101	137,00	137,00	185,00		
		164	56102	154,00	154,00	201,00		

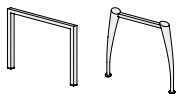

Metallo / Metal / Métal								
W	Y	EQ						

ELEMENTO

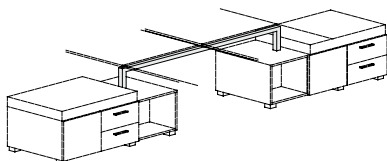

DESCRIZIONE

Cavalletto centrale per scrivanie con piani contrapposti predisposte per 2 serventi portanti H43 (montaggio servente al centro del cavalletto)

N.b.: utilizzare serventi monofacciali o bifacciali

Central trestle for desks with opposing worktops predisposed for 2 H43 bearing pedestals (pedestal assembly at the centre of the trestle)

Note: use single or double sided pedestals

Piètement intermédiaire de bureaux face-à-face pour 2 dessertes porteuses H43
(montage desserte au centre du piètement)

Nb: utiliser dessertes à une ou à deux façades

		MISURA	CODICE					
FLY01	SINGOLA SINGLE SIMPLE	124	56106	175,00	175,00	255,00		
		164	56107	195,00	195,00	285,00		



Metallo / Metal / Métal								
W	Y	EQ						

ELEMENTO

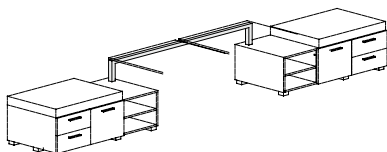

DESCRIZIONE

Cavalletto centrale per scrivanie con piani contrapposti predisposte per 2 serventi portanti H43. (montaggio del servente all'interno del cavalletto)

N.b.: utilizzare serventi monofacciali

Central trestle for desks with opposing worktops predisposed for 2 H43 bearing pedestals. (pedestal assembly on the inside of the trestle)

Note: use single sided pedestals

Piètement intermédiaire de bureaux face-à-face pour 2 dessertes porteuses H43.
(montage de la desserte à l'intérieur du piètement)

NB: Utiliser des dessertes à une seule façade

		MISURA	CODICE					
FLY01	SINGOLA SINGLE SIMPLE	124	56108	175,00	175,00	265,00		
		164	56109	195,00	195,00	296,00		



Metallo / Metal / Métal								
W	Y	EQ						

H72 (piani spessore 1,8)
(worktop thickness 1.8)
(épaisseur des plateaux 1,8)

H73 (piani spessore 2,8)
(worktop thickness 2.8)
(épaisseur des plateaux 2,8)

Elementi per composizioni con struttura cavalletto
Elements for composition with trestle structure
Éléments pour compositions avec structure
piètement

ELEMENTO

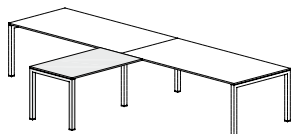

DESCRIZIONE

Piano allungo centrale tra due piani completo di gamba cavalletto cm.60 e traverse in metallo

Return top between two worktops complete with 60 cm trestle leg and metal crosspieces

Plateau de rallonge centrale entre deux plateaux, avec piètement 60 cm et traverses en métal

FLY01

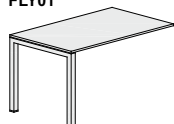

		Piano nobilitato SP.18 mm /18 mm thick melamine worktop Plateau mélaminé SP. 18 mm			
		Struttura / Structure / Structure: W - Y		Struttura / Structure / Structure: EQ	
		G	W - RC - NA - WE	G	W - RC - NA - WE
MISURA	CODICE				
80x60	55971	238,00	241,00	358,00	361,00
100x60	55972	255,00	258,00	375,00	378,00

FLY02



		Piano nobilitato SP.28 mm /28 mm thick melamine worktop Plateau mélaminé h. 28 mm			
		Struttura / Structure / Structure: W - Y		Struttura / Structure / Structure: EQ	
		G	W - RC - NA - WE	G	W - RC - NA - WE
MISURA	CODICE				
80x60	55975	251,00	252,00	371,00	373,00
100x60	55976	273,00	275,00	393,00	395,00

80x60	55977	254,00	256,00	365,00	367,00
100x60	55978	278,00	280,00	389,00	391,00

FLY01



FLY02



FLY 01/02/03

H72 (piani spessore 1,8)
(worktop thickness 1.8)
(épaisseur des plateaux 1,8)

H73 (piani spessore 2,8)
(worktop thickness 2.8)
(épaisseur des plateaux 2,8)

Elementi per composizioni con struttura cavalletto
Elements for composition with trestle structure
Éléments pour compositions avec structure
piètement

ELEMENTO

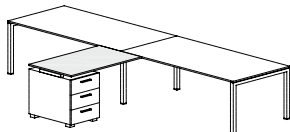

DESCRIZIONE

Piano allungo centrale tra due piani completo di traverse in metallo e supporto cassetiera. (ordinare cassetiera pag. 68)

Return top between two worktops complete with metal crosspieces and drawer unit support. (order drawer unit on page 68)

Plateau de rallonge centrale entre deux plateaux, avec traverses en métal et support pour caisson. (commander caisson page 68)



MISURA CODICE

80x60 **55981**
100x60 **55982**

Piano nobilitato SP.18 mm /18 mm thick melamine worktop Plateau mélaminé SP. 18 mm			
Struttura / Structure / Structure: W - Y		Struttura / Structure / Structure: EQ	
G	W - RC - NA - WE	G	W - RC - NA - WE
211,00	214,00	248,00	251,00
228,00	232,00	265,00	268,00



MISURA CODICE

80x60 **55984**
100x60 **55985**

Piano nobilitato SP.28 mm /28 mm thick melamine worktop Plateau mélaminé h. 28 mm			
Struttura / Structure / Structure: W - Y		Struttura / Structure / Structure: EQ	
G	W - RC - NA - WE	G	W - RC - NA - WE
224,00	226,00	261,00	263,00
246,00	248,00	283,00	285,00

H72 (piani spessore 1,8)
(worktop thickness 1.8)
(épaisseur des plateaux 1,8)

H73 (piani spessore 2,8)
(worktop thickness 2.8)
(épaisseur des plateaux 2,8)

Elementi per composizioni con struttura cavalletto
Elements for composition with trestle structure
Éléments pour compositions avec structure
piètement

ELEMENTO

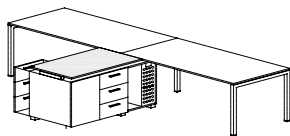

DESCRIZIONE

Piano allungo centrale tra due piani completo di traverse in metallo e supporto servente H63. (ordinare servente monofacciale o bifacciale pag. 69)
Return top between two worktops complete with metal crosspieces and H63 pedestal support. (order single or double sided pedestal on page 69)
Extension centrale entre deux plateaux avec traverses en métal et support pour desserte H63. (commander desserte à une façade ou double-face page 69)



MISURA	CODICE	Piano nobilitato SP.18 mm /18 mm thick melamine worktop Plateau mélaminé SP. 18 mm			
		Struttura / Structure / Structure: W - Y		Struttura / Structure / Structure: EQ	
		G	W - RC - NA - WE	G	W - RC - NA - WE
100x60	55992	228,00	231,00	265,00	268,00



MISURA	CODICE	Piano nobilitato SP.28 mm /28 mm thick melamine worktop Plateau mélaminé h. 28 mm			
		Struttura / Structure / Structure: W - Y		Struttura / Structure / Structure: EQ	
		G	W - RC - NA - WE	G	W - RC - NA - WE
100x60	55994	247,00	248,00	283,00	285,00

FLY 01/02/03

H72 (piani spessore 1,8)
(worktop thickness 1.8)
(épaisseur des plateaux 1,8)

H73 (piani spessore 2,8)
(worktop thickness 2.8)
(épaisseur des plateaux 2,8)

Elementi per composizioni con struttura cavalletto
Elements for composition with trestle structure
Éléments pour compositions avec structure
piètement

ELEMENTO

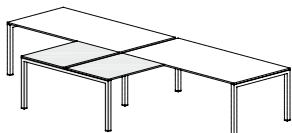

DESCRIZIONE

Coppia piani allungo centrali completi di cavalletto terminale e traverse in metallo
Pair of central return tops with end trestle and metal crosspieces
Paire d'extensions centrales avec piètement terminal et traverses en métal

		Piano nobilitato SP.18 mm /18 mm thick melamine worktop Plateau mélaminé SP. 18 mm				
		Struttura / Structure / Structure: W - Y		Struttura / Structure / Structure: EQ		
		G	W - RC - NA - WE	G	W - RC - NA - WE	
MISURA	CODICE					
FLY01 	80x124	56001	439,00	444,00	568,00	574,00
	100x124	56002	473,00	479,00	602,00	608,00
FLY02 	80x124	56003	411,00	417,00	547,00	552,00
	100x124	56004	448,00	454,00	583,00	589,00

		Piano nobilitato SP.28 mm /28 mm thick melamine worktop Plateau mélaminé h. 28 mm				
		Struttura / Structure / Structure: W - Y		Struttura / Structure / Structure: EQ		
		G	W - RC - NA - WE	G	W - RC - NA - WE	
MISURA	CODICE					
FLY01 	80x124	56005	465,00	468,00	594,00	597,00
	100x124	56006	509,00	513,00	639,00	642,00
FLY02 	80x124	56007	437,00	440,00	573,00	576,00
	100x124	56008	484,00	488,00	620,00	623,00

H72 (piani spessore 1,8)
(worktop thickness 1.8)
(épaisseur des plateaux 1,8)

H73 (piani spessore 2,8)
(worktop thickness 2.8)
(épaisseur des plateaux 2,8)

Elementi per composizioni con struttura cavalletto
Elements for composition with trestle structure
Éléments pour compositions avec structure
piètement

ELEMENTO

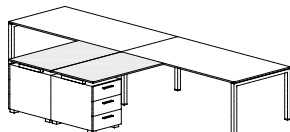

DESCRIZIONE

Coppia piani allungo centrale completo di traverse in metallo e supporto cassetiera. (ordinare cassetiera pag. 68)

Pair of central return tops complete with metal crosspieces and drawer unit support.
(order drawer unit on page 68)

Paire d'extensions centrales avec traverses en métal et support pour caisson.
(commander caisson page 68)

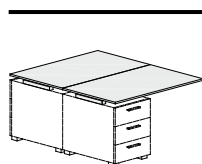

		Piano nobilitato SP.18 mm /18 mm thick melamine worktop Plateau mélaminé SP. 18 mm			
		Struttura / Structure / Structure: W - Y		Struttura / Structure / Structure: EQ	
MISURA	CODICE	G	W - RC - NA - WE	G	W - RC - NA - WE
80x124	56011	394,00	399,00	467,00	472,00
100x124	56012	427,00	434,00	501,00	507,00



		Piano nobilitato SP.28 mm /28 mm thick melamine worktop Plateau mélaminé h. 28 mm			
		Struttura / Structure / Structure: W - Y		Struttura / Structure / Structure: EQ	
MISURA	CODICE	G	W - RC - NA - WE	G	W - RC - NA - WE
80x124	56014	420,00	423,00	493,00	496,00
100x124	56015	464,00	467,00	537,00	541,00

FLY 01/02/03

H72 (piani spessore 1,8)
 (worktop thickness 1.8)
 (épaisseur des plateaux 1,8)

H73 (piani spessore 2,8)
 (worktop thickness 2.8)
 (épaisseur des plateaux 2,8)

Elementi per composizioni con struttura cavalletto
 Elements for composition with trestle structure
 Éléments pour compositions avec structure
 piètement

ELEMENTO

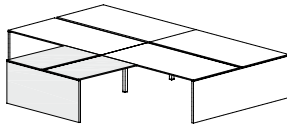

DESCRIZIONE

Coppia piani allungo centrale completi di fianco in nobilitato terminale e traverse in metallo

Pair of central return tops complete with panel leg in end melamine and metal crosspieces

Paire d'extensions centrales avec parement en mélaminé et traverses en métal.

FLY03

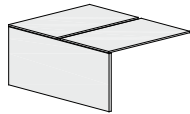

MISURA	CODICE
80x124	56031
100x124	56032

Piano nobilitato SP.18 mm /18 mm thick melamine worktop Plateau mélaminé SP. 18 mm			
G	W - RC - NA - WE		
429,00	437,00		
463,00	472,00		

FLY03

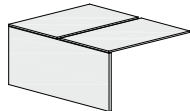

MISURA	CODICE
80x124	56034
100x124	56035

Piano nobilitato SP.28 mm /28 mm thick melamine worktop Plateau mélaminé h. 28 mm			
G	W - RC - NA - WE		
455,00	461,00		
499,00	506,00		

H72 (piani spessore 1,8)
(worktop thickness 1.8)
(épaisseur des plateaux 1,8)

H73 (piani spessore 2,8)
(worktop thickness 2.8)
(épaisseur des plateaux 2,8)

Elementi per composizioni con struttura cavalletto
Elements for composition with trestle structure
Éléments pour compositions avec structure
piètement

ELEMENTO

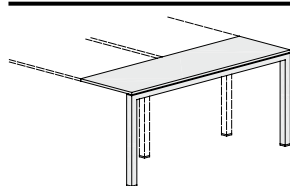

DESCRIZIONE

Piano terminale completo di cavalletto iniziale-terminale e traverse in metallo
End worktop complete with start-end trestle and metal crosspieces
Plateau terminal avec piètement début-fin de composition et traverses en métal

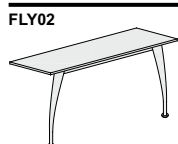
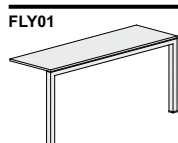

		Piano nobilitato SP.18 mm /18 mm thick melamine worktop Plateau mélaminé SP. 18 mm				
		Struttura / Structure / Structure: W - Y		Struttura / Structure / Structure: EQ		
		G	W - RC - NA - WE	G	W - RC - NA - WE	
MISURA	CODICE					
FLY01	60x124	56051	342,00	346,00	472,00	476,00
	60x164	56052	370,00	375,00	543,00	548,00
FLY02	60x124	56053	308,00	312,00	443,00	447,00
	60x164	56054	330,00	335,00	477,00	482,00

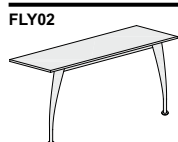
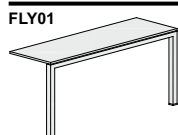

		Piano nobilitato SP.28 mm /28 mm thick melamine worktop Plateau mélaminé h. 28 mm				
		Struttura / Structure / Structure: W - Y		Struttura / Structure / Structure: EQ		
		G	W - RC - NA - WE	G	W - RC - NA - WE	
MISURA	CODICE					
FLY01	60x124	56055	356,00	358,00	486,00	488,00
	60x164	56056	394,00	396,00	567,00	569,00
FLY02	60x124	56057	322,00	324,00	457,00	460,00
	60x164	56058	354,00	357,00	501,00	503,00

FLY 01/02/03

H72 (piani spessore 1,8)
(worktop thickness 1.8)
(épaisseur des plateaux 1,8)

H73 (piani spessore 2,8)
(worktop thickness 2.8)
(épaisseur des plateaux 2,8)

Tavoli riunione
Meeting tables
Tables de réunion

ELEMENTO

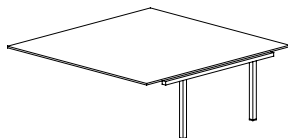

DESCRIZIONE

Allungo quadrato per tavolo riunioni completo di cavalletto centrale e traverse in metallo

N.b.: utilizzare le scrivanie singole come piano iniziale del tavolo riunioni

Square extension for meeting table complete with central trestle and metal crosspieces

Note: use single desks as the start worktop for meeting tables

Extension carrée pour table de réunion avec piètement central et traverses en métal

NB: Utilisez les bureaux simples comme plateau initial pour la table de réunion.

FLY01



MISURA CODICE

120x124 **56205**
160x164 **56206**

Piano nobilitato SP.18 mm /18 mm thick melamine worktop Plateau mélaminé SP. 18 mm			
Struttura / Structure / Structure: W - Y		Struttura / Structure / Structure: EQ	
G	W - RC - NA - WE	G	W - RC - NA - WE
474,00	480,00	609,00	615,00
555,00	564,00	735,00	745,00

FLY02



120x124 **56207**
160x164 **56208**

Piano nobilitato SP.28 mm /28 mm thick melamine worktop Plateau mélaminé h. 28 mm			
Struttura / Structure / Structure: W - Y		Struttura / Structure / Structure: EQ	
G	W - RC - NA - WE	G	W - RC - NA - WE
480,00	486,00	587,00	593,00
566,00	576,00	684,00	694,00

FLY01



MISURA CODICE
120x124 **56211**
160x164 **56212**

FLY02



120x124 **56213**
160x164 **56214**

H73 (piani spessore 2,8)
(worktop thickness 2.8)
(épaisseur des plateaux 2,8)

Tavoli riunione con struttura puntiforme
Meeting tables with punctiform structure
Tables de réunion avec structure ponctuelle

ELEMENTO

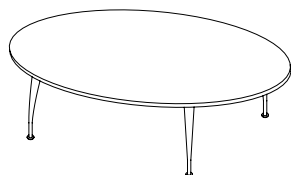

DESCRIZIONE

Tavolo riunioni ovale completo di nr.4 gambe puntiformi e travi antiflessione
Oval Meeting table complete with 4 punctiform legs and bend-resistant beams
Table de réunion ovale avec 4 pieds effilés et traverses anti-flexion

FLY02



MISURA	CODICE
210x120	56231

Piano nobilitato SP.28 mm /28 mm thick melamine worktop Plateau mélaminé h. 28 mm			
Struttura / Structure / Structure: W - Y		Struttura / Structure / Structure: EQ	
G	W - RC - NA - WE	G	W - RC - NA - WE
553,00	556,00	829,00	832,00

ELEMENTO

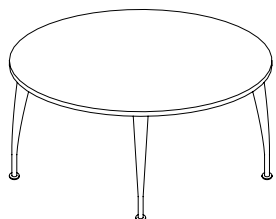

DESCRIZIONE

Tavolo riunioni rotondo completo di nr.4 gambe puntiformi
Round Meeting table complete with 4 punctiform legs
Table de réunion ronde avec 4 pieds effilés

FLY02



MISURA	CODICE
Ø120	56232

Piano nobilitato SP.28 mm /28 mm thick melamine worktop Plateau mélaminé h. 28 mm			
Struttura / Structure / Structure: W - Y		Struttura / Structure / Structure: EQ	
G	W - RC - NA - WE	G	W - RC - NA - WE
339,00	341,00	615,00	617,00

FLY 01/02/03

ELEMENTO

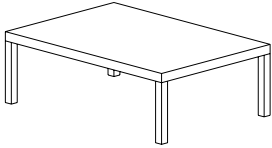

DESCRIZIONE

Tavolo rettangolare con gambe cromate Fly01
 Rectangular table with chrome-plated legs Fly01
 Table rectangulaire avec pieds chromes Fly01

		Piano nobilitato SP.28 mm /28 mm thick melamine worktop Plateau mélaminé h. 28 mm			
MISURA	CODICE	RC	WE	NA	
120x60	56221	397,00	397,00	397,00	

ELEMENTO

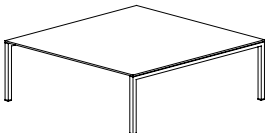

DESCRIZIONE

Tavolo quadrato con gambe cromate Fly01
 Square table with chrome-plated legs Fly01
 Table carree avec pieds chromes Fly01

		Piano nobilitato SP.28 mm /28 mm thick melamine worktop Plateau mélaminé h. 28 mm			
MISURA	CODICE	RC	WE	NA	
60x60	56222	367,00	367,00	367,00	

ELEMENTO



DESCRIZIONE

Cassettiera con 3 cassetti interni in metallo (viene fornita già assemblata)

Drawer unit with 3 internal metal drawers (comes already assembled)

Caisson 3 tiroirs internes en métal (livré déjà assemblé)

		Nobilitato / Melamine / Mélamine					
MISURA	CODICE	G	W	Z	RC	NA	WE
MANIGLIA IN PALSTICA RAL 9006 RAL 9006 PLASTIC HANDLE POIGNEE EN PLASTIQUE RAL 9006	39,5x60 56291	270,00	270,00	270,00	270,00	270,00	270,00
MANIGLIA IN METALLO ECOCROMO ECO-CHROME METAL HANDLE POIGNEE EN METAL ECO CHROME	39,5x60 56292	279,00	279,00	279,00	279,00	279,00	279,00

ELEMENTO

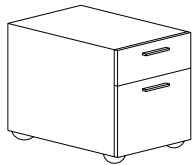

DESCRIZIONE

Cassettiera con cassetto e schedario in metallo (viene fornita già assemblata)

Drawer unit with drawer and metal file drawer (comes already assembled)

Caisson avec tiroir et fichier métal (livré déjà assemblé)

		Nobilitato / Melamine / Mélamine					
MISURA	CODICE	G	W	Z	RC	NA	WE
MANIGLIA IN PALSTICA RAL 9006 RAL 9006 PLASTIC HANDLE POIGNEE EN PLASTIQUE RAL 9006	39,5x60 56294	293,00	293,00	293,00	293,00	293,00	293,00
MANIGLIA IN METALLO ECOCROMO ECO-CHROME METAL HANDLE POIGNEE EN METAL ECO CHROME	39,5x60 56295	302,00	302,00	302,00	302,00	302,00	302,00

ELEMENTO

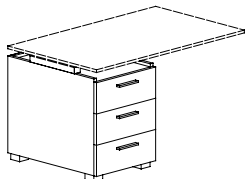

DESCRIZIONE

Cassettiera con 3 cassetti interni in metallo (viene fornita già assemblata)

Drawer unit with 3 internal metal drawers (comes already assembled)

Caisson 3 tiroirs internes en métal (livré déjà assemblé)

		Nobilitato / Melamine / Mélamine						
MISURA	CODICE	G	W	Z	RC	NA	WE	
MANIGLIA IN PALSTICA RAL 9006 RAL 9006 PLASTIC HANDLE POIGNEE EN PLASTIQUE RAL 9006	39,5x60 56311	328,00	340,00	340,00	340,00	340,00	340,00	
MANIGLIA IN METALLO ECOCROMO ECO-CHROME METAL HANDLE POIGNEE EN METAL ECO CHROME	39,5x60 56312	340,00	352,00	352,00	352,00	352,00	352,00	

ELEMENTO

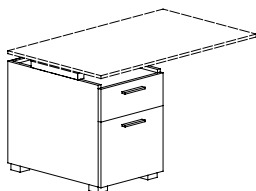

DESCRIZIONE

Cassettiera con cassetto e schedario in metallo (viene fornita già assemblata)

Drawer unit with drawer and metal file drawer (comes already assembled)

Caisson avec tiroir et fichier métal (livré déjà assemblé)

		Nobilitato / Melamine / Mélamine						
MISURA	CODICE	G	W	Z	RC	NA	WE	
MANIGLIA IN PALSTICA RAL 9006 RAL 9006 PLASTIC HANDLE POIGNEE EN PLASTIQUE RAL 9006	39,5x60 56313	312,00	326,00	326,00	326,00	326,00	326,00	
MANIGLIA IN METALLO ECOCROMO ECO-CHROME METAL HANDLE POIGNEE EN METAL ECO CHROME	39,5x60 56314	319,00	333,00	333,00	333,00	333,00	333,00	

ELEMENTO

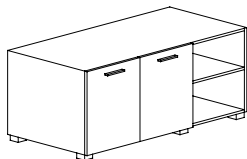

DESCRIZIONE

Servente monofacciale con 2 ante e vano a giorno (viene fornito già assemblato) (il disegno si riferisce al servente SX)

Single sided pedestal with 2 doors and open shelf (comes already assembled) (the drawing refers to the SX pedestal)

Desserte à une seule façade avec 2 portes et un espace ouvert (produit livré déjà assemblé) (le schéma se rapporte à la desserte SX)

MISURA	CODICE	Nobilitato / Melamine / Mélamine					
		G	W	Z	RC	NA	WE
120x60	DX 56321	404,00	433,00	433,00	433,00	433,00	433,00
	SX 56322						
120x60	DX 56323	412,00	442,00	442,00	442,00	442,00	442,00
	SX 56324						

MANIGLIA IN PALSTICA RAL 9006
RAL 9006 PLASTIC HANDLE
POIGNEE EN PLASTIQUE RAL 9006

MANIGLIA IN METALLO ECOCROMO
ECO-CHROME METAL HANDLE
POIGNEE EN METAL ECO CHROME

ELEMENTO

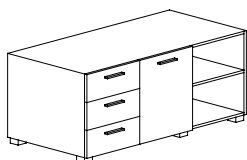

DESCRIZIONE

Servente monofacciale con anta, 3 cassetti in metallo e vano a giorno (viene fornito già assemblato) (il disegno si riferisce al servente SX)

Single sided pedestal with door, 3 metal drawers and an open shelf (comes already assembled) (the drawing refers to the SX pedestal)

Desserte à une seule façade avec porte, 3 tiroirs en métal et compartiment ouvert (produit livré déjà assemblé) (le schéma se rapporte à la desserte SX)

MISURA	CODICE	Nobilitato / Melamine / Mélamine					
		G	W	Z	RC	NA	WE
120x60	DX 56326	566,00	593,00	593,00	593,00	593,00	593,00
	SX 56327						
120x60	DX 56328	574,00	601,00	601,00	601,00	601,00	601,00
	SX 56329						

MANIGLIA IN PALSTICA RAL 9006
RAL 9006 PLASTIC HANDLE
POIGNEE EN PLASTIQUE RAL 9006

MANIGLIA IN METALLO ECOCROMO
ECO-CHROME METAL HANDLE
POIGNEE EN METAL ECO CHROME

ELEMENTO

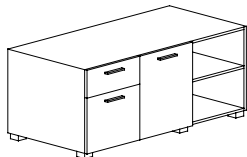

DESCRIZIONE

Servente monofacciale con anta, cassetto schedario in metallo e vano a giorno (viene fornito già assemblato) (il disegno si riferisce al servente SX)

Single sided pedestal with door, metal file drawer and an open shelf (comes already assembled) (the drawing refers to the SX pedestal)

Desserte à une seule façade avec porte, tiroir fichier en métal et compartiment ouvert (produit livré déjà assemblé) (le schéma se rapporte à la desserte SX)

MISURA	CODICE	Nobilitato / Melamine / Mélamine					
		G	W	Z	RC	NA	WE
120x60	DX 56330	551,00	580,00	580,00	580,00	580,00	580,00
	SX 56331						
120x60	DX 56332	563,00	592,00	592,00	592,00	592,00	592,00
	SX 56333						

MANIGLIA IN PALSTICA RAL 9006
RAL 9006 PLASTIC HANDLE
POIGNEE EN PLASTIQUE RAL 9006

MANIGLIA IN METALLO ECOCROMO
ECO-CHROME METAL HANDLE
POIGNEE EN METAL ECO CHROME

ELEMENTO

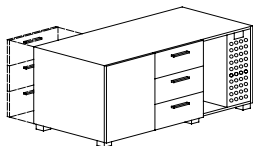

DESCRIZIONE

Servente bifacciale con 3 cassetti in metallo contrapposti e vano porta CPU su entrambi i lati – spazio utile per CPU 19,5 cm. (viene fornito già assemblato)
 Double sided pedestal with 3 opposing metal drawers and CPU holder box on both sides – usable space for CPU 19.5 cm. (comes already assembled)
 Desserte double-face, 3 tiroirs en métal dos-à-dos et compartiment porte UC de chaque côté - espace utile pour UC 19,5 cm. (produit livré déjà assemblé)

		Nobilitato / Melamine / Mélamine						
MISURA	CODICE	G	W	Z	RC	NA	WE	
MANIGLIA IN PALSTICA RAL 9006 RAL 9006 PLASTIC HANDLE POIGNEE EN PLASTIQUE RAL 9006	120x60 56341	755,00	777,00	777,00	777,00	777,00	777,00	
MANIGLIA IN METALLO ECOCROMO ECO-CHROME METAL HANDLE POIGNEE EN METAL ECO CHROME	120x60 56343	778,00	800,00	800,00	800,00	800,00	800,00	

ELEMENTO

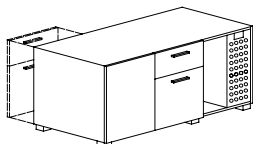

DESCRIZIONE

Servente bifacciale con schedari in metallo contrapposti e vano porta CPU su entrambi i lati – spazio utile per CPU 19,5 cm. (viene fornito già assemblato)
 Double sided pedestal with opposing metal file drawers and CPU holder box on both sides – usable space for CPU 19.5 cm. (comes already assembled)
 Desserte double-face, fichiers en métal dos-à-dos et compartiment porte UC de chaque côté - espace utile pour UC 19,5 cm. (produit livré déjà assemblé)

		Nobilitato / Melamine / Mélamine						
MISURA	CODICE	G	W	Z	RC	NA	WE	
MANIGLIA IN PALSTICA RAL 9006 RAL 9006 PLASTIC HANDLE POIGNEE EN PLASTIQUE RAL 9006	120x60 56345	721,00	746,00	746,00	746,00	746,00	746,00	
MANIGLIA IN METALLO ECOCROMO ECO-CHROME METAL HANDLE POIGNEE EN METAL ECO CHROME	120x60 56347	737,00	762,00	762,00	762,00	762,00	762,00	

ELEMENTO

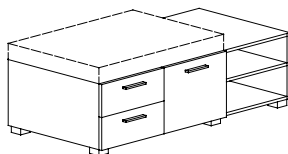

DESCRIZIONE

Servente monofacciale con 2 cassetti in metallo, schedario e vano a giorno (viene fornito già assemblato) (il disegno si riferisce al servente SX). (ordinare cuscino pag.72)

Single sided pedestal with 2 metal drawers, file drawer and an open shelf (comes already assembled) (the drawing refers to the SX pedestal)

(order cushion on page 72)

Desserte à une seule façade, 2 tiroirs en métal, tiroir fichier et compartiment ouvert (produit livré déjà assemblé) (le schéma se rapporte à la desserte SX)

(commander coussin page 72)

		Nobilitato / Melamine / Mèlamine					
MISURA	CODICE	G	W	Z	RC	NA	WE
MANIGLIA IN PALSTICA RAL 9006 RAL 9006 PLASTIC HANDLE POIGNEE EN PLASTIQUE RAL 9006	120x60 DX 56351	532,00	555,00	555,00	555,00	555,00	555,00
	SX 56352						
MANIGLIA IN METALLO ECOCROMO ECO-CHROME METAL HANDLE POIGNEE EN METAL ECO CHROME	120x60 DX 56353	543,00	566,00	566,00	566,00	566,00	566,00
	SX 56354						

ELEMENTO

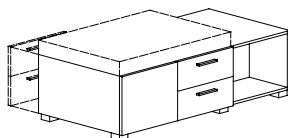

DESCRIZIONE

Servente bifacciale con 2 cassetti in metallo contrapposti e vano a giorno (viene fornito già assemblato) (ordinare cuscino pag.72)

Double sided pedestal with 2 opposing metal drawers and an open compartment (comes already assembled) (order cushion on page 72)

Desserte double-face, 2 tiroirs en métal dos-à-dos et compartiment ouvert (produit livré déjà assemblé) (commander coussin page 72)

		Nobilitato / Melamine / Mèlamine					
MISURA	CODICE	G	W	Z	RC	NA	WE
MANIGLIA IN PALSTICA RAL 9006 RAL 9006 PLASTIC HANDLE POIGNEE EN PLASTIQUE RAL 9006	120x60 56355	555,00	575,00	575,00	575,00	575,00	575,00
MANIGLIA IN METALLO ECOCROMO ECO-CHROME METAL HANDLE POIGNEE EN METAL ECO CHROME	120x60 56357	572,00	592,00	592,00	592,00	592,00	592,00

ELEMENTO

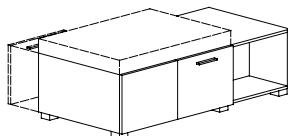

DESCRIZIONE

Servente bifacciale con 2 schedari in metallo contrapposti e vano a giorno (viene fornito già assemblato) (ordinare cuscino pag.72)

Double sided pedestal with 2 opposing metal file drawers and an open compartment (comes already assembled) (order cushion on page 72)

Desserte double-face, 2 tiroirs fichier en métal dos-à-dos et compartiment ouvert (produit livré déjà assemblé) (commander coussin page 72)

		Nobilitato / Melamine / Mèlamine					
MISURA	CODICE	G	W	Z	RC	NA	WE
MANIGLIA IN PALSTICA RAL 9006 RAL 9006 PLASTIC HANDLE POIGNEE EN PLASTIQUE RAL 9006	120x60 56359	519,00	543,00	543,00	543,00	543,00	543,00
MANIGLIA IN METALLO ECOCROMO ECO-CHROME METAL HANDLE POIGNEE EN METAL ECO CHROME	120x60 56361	527,00	551,00	551,00	551,00	551,00	551,00

ELEMENTO

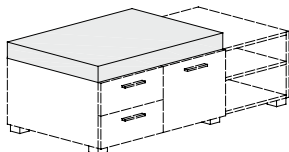

DESCRIZIONE

Cuscino da applicare ai serventi H43
 Cushion for application on pedestal H43
 Coussin pour dessertes H43

COLORE DEI RIVESTIMENTI
 COVERING COLOUR
 COULEUR DE REVÊTEMENT

MISURA CODICE
 80x60 **56367**

Tessuto – Categorie di rivestimento / Fabric – Covering categories Tissu - catégories de revêtement							
D	M						
141,00	158,00						
	DN	MN					
	DG	MG					
	DS						
	DR	MR					
	DB	MB					
		MT					
		MP					
		MA					
		MX					
		MV					

ELEMENTO

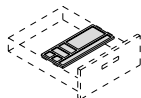

DESCRIZIONE

Vaschetta porta cancelleria
 Office supply tray
 Plumier

MISURA CODICE
 56305

Plastica / Plastic / Plastique							
C							
4,00							

ELEMENTO

DESCRIZIONE

Maggiorazione per sistema di rientro ammortizzato per cassetti (prezzo per ogni cassetto). N.b.: funzionamento con portata massima di 20kg per cassetto
N.b.: in presenza di pavimenti con moquette, nelle cassettiere su ruote, il sistema di ammortizzatori non funziona per il cassetto schedario (attrito tra 5° ruota e pavimento)
 Extra charge for soft closing hinges (price for each drawer)
 Note: operational guaranteed with a maximum of 20 Kg weight per drawer
 Note: when using drawer units on castors on carpet flooring the soft closing mechanism cannot be applied to the file drawer due to the friction between the 5th wheel and the carpet
 Supplément pour système de fermeture en douceur des tiroirs (prix pour chaque tiroir)
 NB: fonctionnement avec charge max. de 20 kg par tiroir
 NB: Sur la moquette, pour les caisson à roulettes, le système d'amortissement ne fonctionne pas pour le tiroir fichier (frottement de la 5ème roulette sur le plancher)

MISURA CODICE
 10,00

10,00							
-------	--	--	--	--	--	--	--

Pianetto sopraelevato
 Raised shelf
 Tablette surélevée

ELEMENTO

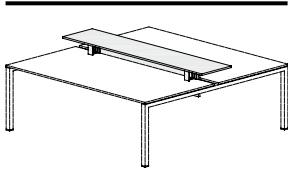

DESCRIZIONE

**Piano sopraelevato per scrivanie con piani contrapposti complete di staffe in metallo per aggancio al piano scrivania (altezza sopra piano cm.15)
 N.b.: nel pannello verticale possono essere applicate le scatole precablate di elettrificazione (nr.4 per cm.100-120 – nr.8 per cm.140-160-180)**

Raised shelf for desks with opposing worktops complete with metal brackets to hook to the desk worktop (height above desktop 15 cm)

Note: the pre-cabled electrification boxes can be installed on the vertical panels (4 for 100-120 cm – 8 for 140-160-180 cm)

Tablette surélevée pour bureaux face-à-face avec étriers métalliques pour la fixation sur le bureau (hauteur au-dessus du plateau 15 cm.)

NB: Les boîtes pré-câblées d'électrification (4pcs pour dim. 100-120 cm - 8pcs pour dim. 140-160-180 cm) peuvent être appliquées sur le panneau vertical.

		Nobilitato / Melamine / Mélamine		
		Struttura / Structure / Structure: W - Y		
MISURA	CODICE	G	W - RC - NA - WE	
100x34	56412	125,00	132,00	
120x34	56413	136,00	145,00	
140x34	56414	144,00	153,00	
160x34	56415	156,00	167,00	
180x34	56416	162,00	174,00	

ELEMENTO

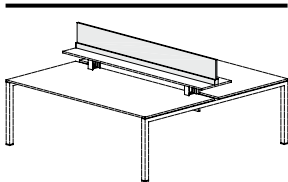

DESCRIZIONE

Screen H35 su barra di alluminio da applicare sopra al piano sopraelevato per scrivania (altezza sopra piano cm.50)

H35 screen on aluminium bar to be applied above the raised shelf for desk (height above desktop 50 cm)

Écran H35 barre en aluminium à appliquer sur la tablette surélevée pour bureau (hauteur au-dessus du plateau 50 cm.)

		Nobilitato / Melamine / Mélamine		Vetro / Glass / Verre	
		Struttura / Structure / Structure: W - Y		Struttura / Structure / Structure: W - Y	
MISURA	CODICE	G	W - RC - NA - WE	SV	
100x4	56422	115,00	115,00	204,00	
120x4	56423	125,00	125,00	237,00	
140x4	56424	137,00	137,00	268,00	
160x4	56425	155,00	155,00	299,00	
180x4	56426	167,00	167,00	331,00	

FLY 01/02/03

Pianetto soprelevato
 Raised shelf
 Tablette surélevée

ELEMENTO

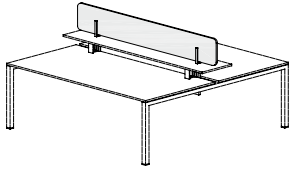

DESCRIZIONE

Screen fonoassorbente H45 da applicare sopra al piano sopraelevato per scrivania (altezza sopra piano cm.60)
 Soundproof H45 screen on aluminium bar to be applied above the raised shelf for desk (height above desktop 60 cm)
 Écran H45 anti-bruit à appliquer sur la tablette surélevée pour bureau (hauteur au-dessus du plateau 60 cm.)

		Tessuto / Fabric / Tissu					
		Struttura / Structure / Structure: W - Y					
MISURA	CODICE	GT	KT	RT	DT	BT	
120x3	56428	456,00	456,00	456,00	456,00	456,00	
160x3	56429	500,00	500,00	500,00	500,00	500,00	

ELEMENTO

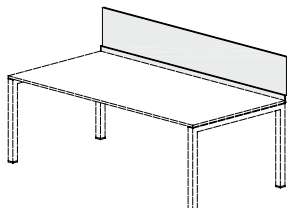

DESCRIZIONE

Screen H35 su barra di alluminio per scrivanie con piani singoli completi di staffe in metallo per aggancio alla struttura della scrivania

H35 screen on aluminium bar for desks with single worktop complete with metal brackets to hook to the desk structure

Écran H35 barre en aluminium pour bureaux à plateaux individuels avec étriers en métal pour fixation à la structure du bureau

MISURA	CODICE	Nobilitato / Melamine / Mèlamine		Vetro / Glass / Verre	
		Struttura / Structure / Structure: W - Y		Struttura / Structure / Structure: W - Y	
		G	W - RC - NA - WE	SV	
80x4	56431	153,00	154,00	215,00	
100x4	56432	165,00	166,00	245,00	
120x4	56433	177,00	179,00	277,00	
140x4	56434	190,00	192,00	308,00	
160x4	56435	211,00	213,00	340,00	
180x4	56436	225,00	227,00	372,00	

ELEMENTO

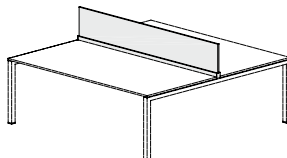

DESCRIZIONE

Screen H35 su barra di alluminio per scrivanie con piani contrapposti completi di staffe in metallo per aggancio alla struttura della scrivania

H35 screen on aluminium bar for desks with opposing worktops complete with metal brackets to hook to the desk structure

Écran H35 barre en aluminium pour bureaux à plateaux face-à-face avec étriers en métal pour fixation à la structure du bureau

MISURA	CODICE	Nobilitato / Melamine / Mèlamine		Vetro / Glass / Verre	
		Struttura / Structure / Structure: W - Y		Struttura / Structure / Structure: W - Y	
		G	W - RC - NA - WE	SV	
80x4	56441	167,00	168,00	229,00	
100x4	56442	179,00	180,00	259,00	
120x4	56443	191,00	193,00	291,00	
140x4	56444	204,00	206,00	322,00	
160x4	56445	225,00	227,00	354,00	
180x4	56446	239,00	241,00	386,00	

H35

Screen su barra di alluminio
 Screen on aluminium bar
 Écran de barre d'aluminium

ELEMENTO

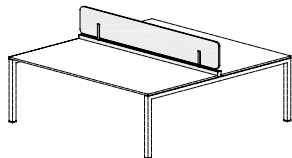

DESCRIZIONE

Screen fonoassorbente H50 su barra di alluminio per scrivanie con piani contrapposti completi di staffe in metallo per aggancio alla struttura della scrivania
 Soundproof H50 screen on aluminium bar for desks with opposing worktops complete with metal brackets to hook to the desk structure
 Écran anti-bruit H50 barre en aluminium pour bureaux à plateaux face-à-face avec étriers en métal pour fixation à la structure du bureau

		Tessuto / Fabric / Tissu					
		Struttura / Structure / Structure: W - Y					
MISURA	CODICE	GT	KT	RT	DT	BT	
120x4	56448	580,00	580,00	580,00	580,00	580,00	
160x4	56449	639,00	639,00	639,00	639,00	639,00	

ELEMENTO

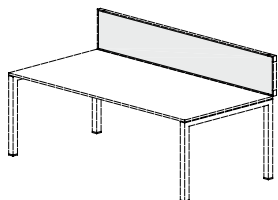

DESCRIZIONE

Screen H35 con telaio perimetrale di alluminio per scrivanie con piani singoli complete di staffe in metallo per aggancio alla struttura della scrivania

H35 screens with aluminium frame border for desks with single worktop complete with metal brackets to hook to the desk structure

Écran H35 avec cadre de pourtour en aluminium pour bureaux à plateaux individuels avec étriers en métal pour fixation à la structure du bureau.

		Nobilitato / Melamine / Mélamine			
		Profili Alluminio / Aluminium Profile / Profilés en aluminium: W - Y			
MISURA	CODICE	G	W - RC - NA - WE		
80x2.8	56461	235,00	235,00		
100x2.8	56462	248,00	248,00		
120x2.8	56463	260,00	260,00		
140x2.8	56464	279,00	279,00		
160x2.8	56465	291,00	291,00		
180x2.8	56466	305,00	305,00		

		Tessuto – Categorie di rivestimento / Fabric – Covering categories Tissu - catégories de revêtement			
		Profili Alluminio / Aluminium Profile / Profilés en aluminium: W - Y			
MISURA	CODICE	D	M		
80x2.8	56461	315,00	333,00		
100x2.8	56462	342,00	364,00		
120x2.8	56463	368,00	395,00		
140x2.8	56464	401,00	431,00		
160x2.8	56465	427,00	462,00		
180x2.8	56466	454,00	493,00		

COLORE DEI RIVESTIMENTI COVERING COLOUR COULEUR DE REVETEMENT		DN	MN		
		DG	MG		
		DS			
		DR	MR		
		DB	MB		
			MT		
			MP		
			MA		
			MX		
			MV		

ELEMENTO

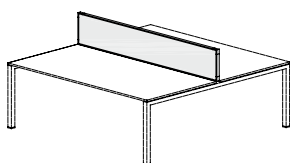

DESCRIZIONE

Screen H35 con telaio perimetrale di alluminio per scrivanie con piani contrapposti complete di staffe in metallo per aggancio alla struttura della scrivania

H35 screens with aluminium frame border for desks with opposing worktops complete with metal brackets to hook to the desk structure

Écran H35 avec cadre en aluminium pour bureaux à plateaux face-à-face avec étriers en métal pour fixation à la structure du bureau.

		Nobilitato / Melamine / Mélamine			
		Profili Alluminio / Aluminium Profile / Profilés en aluminium: W - Y			
MISURA	CODICE	G	W - RC - NA - WE		
80x2.8	56471	252,00	252,00		
100x2.8	56472	265,00	265,00		
120x2.8	56473	277,00	277,00		
140x2.8	56474	296,00	296,00		
160x2.8	56475	308,00	308,00		
180x2.8	56476	321,00	321,00		

		Tessuto – Categorie di rivestimento / Fabric – Covering categories Tissu - catégories de revêtement			
		Profili Alluminio / Aluminium Profile / Profilés en aluminium: W - Y			
MISURA	CODICE	D	M		
80x2.8	56471	332,00	350,00		
100x2.8	56472	358,00	381,00		
120x2.8	56473	385,00	412,00		
140x2.8	56474	417,00	448,00		
160x2.8	56475	444,00	478,00		
180x2.8	56476	471,00	510,00		

COLORE DEI RIVESTIMENTI COVERING COLOUR COULEUR DE REVETEMENT

	DN	MN			
	DG	MG			
	DS				
	DR	MR			
	DB	MB			
		MT			
		MP			
		MA			
		MX			
		MV			

Screen con telaio perimetrale di alluminio
 Screen with aluminium frame border
 Écran avec cadre de pourtour en aluminium

ELEMENTO

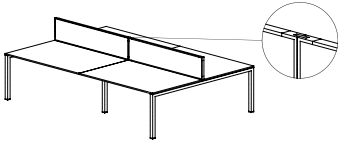

DESCRIZIONE

Connessione lineare per allineamento screen con telaio di alluminio perimetrale
 Linear connection for alignment of screens with aluminium frame border
 Raccord linéaire pour alignement d'écran avec cadre en aluminium

		Metallo / Metal / Métal					
MISURA	CODICE	W	Y				
	56491	12,00	12,00				

ELEMENTO

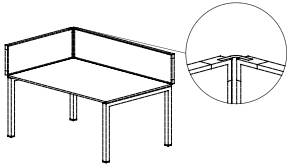

DESCRIZIONE

Connessione 2 vie per allineamento screen con telaio di alluminio perimetrale
 2-way connection for alignment of screens with aluminium frame border
 Raccord à 2 voies pour alignement d'écran avec cadre en aluminium

		Metallo / Metal / Métal					
MISURA	CODICE	W	Y				
	56492	15,00	15,00				

ELEMENTO

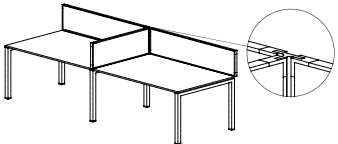

DESCRIZIONE

Connessione 3 vie per allineamento screen con telaio di alluminio perimetrale
 3-way connection for alignment of screens with aluminium frame border
 Raccord à 3 voies pour alignement d'écran avec cadre en aluminium

		Metallo / Metal / Métal					
MISURA	CODICE	W	Y				
	56493	17,00	17,00				

ELEMENTO

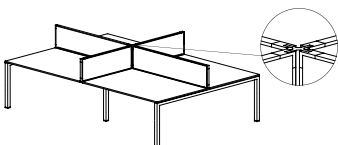

DESCRIZIONE

Connessione 4 vie per allineamento screen con telaio di alluminio perimetrale
 4-way connection for alignment of screens with aluminium frame border
 Raccord à 4 voies pour alignement d'écran avec cadre en aluminium

		Metallo / Metal / Métal					
MISURA	CODICE	W	Y				
	56494	19,00	19,00				

FLY 01/02/03

Accessori per screen su barra di alluminio e screen con telaio perimetrale di alluminio
 Accessories for screens on aluminium bar and screens with aluminium frame border
 Accessoires pour écran sur barre en aluminium et pour écran avec cadre en aluminium

ELEMENTO

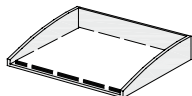

DESCRIZIONE

Vaschetta H5 portafogli A4
 H5 A4 paper tray
 Bac H5 porte-papier A4

		Metallo / Metal / Métal					
MISURA	CODICE	W	Y				
32x22	14460	39,00	39,00				

ELEMENTO

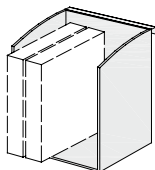

DESCRIZIONE

Vaschetta H32 portaccontentori dox
 H32 dox container tray
 Bac H32 porte-classeurs dox

		Metallo / Metal / Métal					
MISURA	CODICE	W	Y				
32x22	14461	58,00	58,00				

ELEMENTO

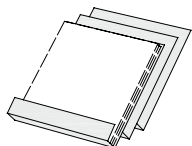

DESCRIZIONE

Vaschetta H22,5 portafogli inclinati
 H22.5 Inclined paper tray
 Bac incliné H22,5 porte-papier

		Metallo / Metal / Métal					
MISURA	CODICE	W	Y				
39x22	14462	73,00	73,00				

ELEMENTO

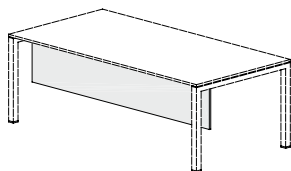

DESCRIZIONE

Modesty panel per scrivanie singole con struttura cavalletto
Modesty panel for single desks with trestle structure
Voile de fond pour bureaux individuels avec structure piètement

FLY01

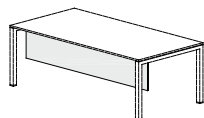

FLY02

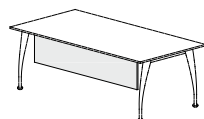

		Nobilitato / Melamine / Mélamine			
		Struttura / Structure / Structure: W - Y		Struttura / Structure / Structure: EQ	
		G	W - RC - NA - WE	G	W - RC - NA - WE
MISURA	CODICE				
100x1.8	56502	102,00	105,00	152,00	156,00
120x1.8	56503	106,00	110,00	156,00	161,00
140x1.8	56504	111,00	115,00	161,00	166,00
160x1.8	56505	119,00	125,00	170,00	175,00
180x1.8	56506	125,00	130,00	175,00	181,00
200x1.8	56507	130,00	137,00	181,00	187,00
100x1.8	56512	98,00	102,00	149,00	152,00
120x1.8	56513	102,00	105,00	152,00	156,00
140x1.8	56514	106,00	110,00	156,00	161,00
160x1.8	56515	111,00	115,00	161,00	166,00
180x1.8	56516	119,00	125,00	170,00	175,00
200x1.8	56517	125,00	130,00	175,00	181,00

Accessori per scrivania
Desk accessories
Accessoires de bureau

ELEMENTO

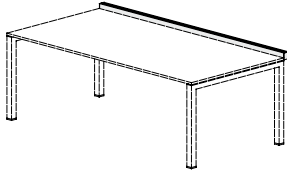

DESCRIZIONE

Barra accessori per scrivanie singole
Accessory bar for single desks
Rail accessoires pour bureaux individuels

		Metallo / Metal / Métal					
MISURA	CODICE	W	Y				
80	56531	124,00	124,00				
100	56532	133,00	133,00				
120	56533	143,00	143,00				
140	56534	153,00	153,00				
160	56535	163,00	163,00				
180	56536	174,00	174,00				

ELEMENTO

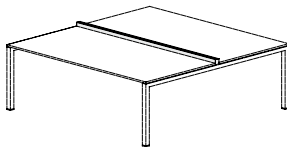

DESCRIZIONE

Barra accessori per scrivanie contrapposte
Accessory bar for opposing desks
Rail accessoires bureaux face-à-face

		Metallo / Metal / Métal					
MISURA	CODICE	W	Y				
80	56541	138,00	138,00				
100	56542	147,00	147,00				
120	56543	157,00	157,00				
140	56544	167,00	167,00				
160	56545	177,00	177,00				
180	56546	188,00	188,00				

ELEMENTO

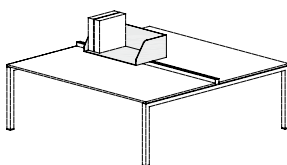

DESCRIZIONE

Contentore porta dox H23 applicabile su barra accessori
H23 dox container that can be applied on the accessory bar
Bac porte-classeurs dox H23 applicable sur rail accessoires

		Metallo / Metal / Métal					
MISURA	CODICE	W	Y				
60x35	56548	237,00	237,00				
80x35	56549	265,00	265,00				

Accessori per scrivania
 Desk accessories
 Accessoires de bureau

ELEMENTO

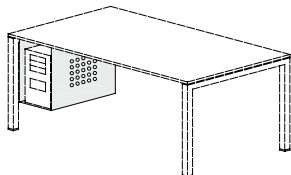

DESCRIZIONE

Porta CPU in lamiera H50 (fissaggio alle travi strutturali della scrivania)

Vano utile L 20,5 – P 50 – H 44

N.B.: non applicabile alle scrivanie con piano in vetro di profondità cm.100

H50 metal CPU holder box (fitting to the structural beams of the desk)

Usable compartment space W 20.5 – D 50 – H 44

Note: cannot be used on 100 cm deep desks with glass worktop

Porte-UC en tôle H50 (à fixer sur les traverses de la structure du bureau)

Dim. utiles: L. 20,5 - P. 50 - H 44

N.B.: ne s'applique pas aux bureaux à plateaux en verre de 100 cm de profondeur

		Metallo / Metal / Métal					
MISURA	CODICE	W	Y				
21x50	56551	90,00	90,00				

DESCRIZIONE

Il sistema FLY prevede vari sistemi di cablaggio delle scrivanie. La risalita verticale dei cavi dal pavimento è consentita dal carter per gamba a cavalletto centrale (art.56571), dalla vertebra per risalita cavi (art.47349) e dalla canalina passacavi per fianco legno (art.43507)

Various desk cable management can be implemented with the FLY system. Vertical running of cables from the floor is possible through the central trestle leg cover (Art. 56571), the cable run spine (Art. 47349) and the cable conduit for wood side (Art. 43507)

Le système FLY prévoit différents systèmes de câblage pour les bureaux. L'électrification verticale est réalisée grâce au carter pour pied cavalier central (art.56571), grâce à l'élément articulé de remontée des câbles (art.47349) et à la goulotte passe-câbles pour parement latéral bois (art.43507)

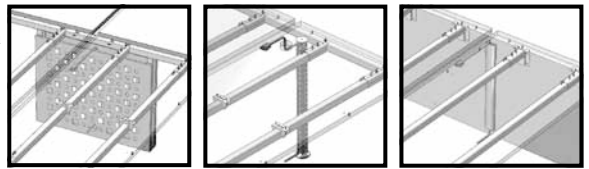

La risalita verticale dei cavi sopra al piano scrivania è consentita da due tipologie di fori passacavi: diametro ø6 cm (art.47351 - 47352) e diametro ø8 cm (art.43505 - 43506) completi di coperchi apribili; dal vano laterale nei pianetti sopraelevati e da due tipologie di top access completi di vaschetta porta prese precablate (art.3842 - 47353) realizzabili su tutti i piani in nobilitato.

Vertical running of cables above the desk top is possible using two types of cable holes: ø6 cm (Art. 47351 - 47352) and ø8 cm (Art. 43505 - 43506) complete with closable cover; from the side compartments in the raised shelves and with two types of top access, complete with pre-cabled socket housing tray (Art. 3842 - 47353) which can be realised on all the melamine worktops.

La remontée des câbles sur le plan de travail est réalisée au moyen de deux types différents d'encoches passe-câbles: diamètre ø6 cm (art.47351 - 47352) et diamètre ø8 cm (art.43505 - 43506) munies de couvercles ouvrants; au moyen du compartiment latéral des tablettes surélevées et de deux types différents de top access munis de boîtes à prises pré-câblées (art.3842 - 47353) applicables sur tous les plateaux mélaminés.

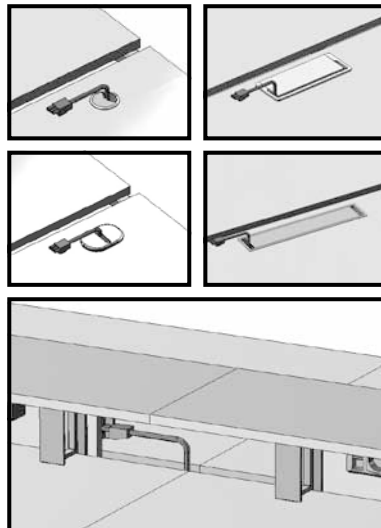

Le scatole precablate multi prese (art.C200 - C201 - C202 - C203) possono essere applicate ai pianetti sopraelevati sia sopra il piano scrivania che sotto di esso, alle due tipologie di vaschette di elettrificazione apribili (cod.56572 - 56573) e ad entrambi i top access.

The pre-cabled multi-socket boxes (Art. C200 - C201 - C202 - C203) can be applied to the raised shelves both above the desktop and under it, to the two types of electrification trays that can be opened (Code 56572 - 56573) and to both top accesses.

Les boîtes pré-câblées à prises multiples (art.C200 - C201 - C202 - C203) peuvent être appliquées aux tablettes surélevées aussi bien sur le plateau du bureau que au-dessous du plateau; elles peuvent être appliquées sur les différents boîtiers d'électrification ouvrants (code 56572 - 56573) et aux deux types de top access.

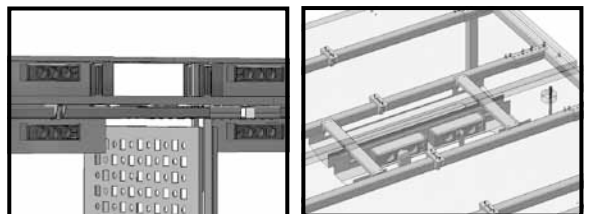

Il camminamento orizzontale e/o la raccolta cavi sotto il piano scrivania è garantito dal cestello raccogli cavi (art.56574) e dalla canalina di elettrificazione raccogli cavi (art.13463 - 13464 - 13465 -13466 - 13467) applicabile a tutti i piani in nobilitato.

Horizontal cable running and/or gathering under the desktop is guaranteed by the cable retainer tray (Art. 56574) and the cable retainer electrification conduit (Art. 13463 - 13464 - 13465 -13466 - 13467) which can be applied to all the melamine worktops.

L'électrification horizontale et/ou le rangement des câbles sous le plateau du bureau sont assurés par le panier de support des câbles (art.56574) et par la goulotte d'électrification passe-câbles (art.13463 - 13464 - 13465 -13466 - 13467), applicables à tous les plateaux mélaminés.

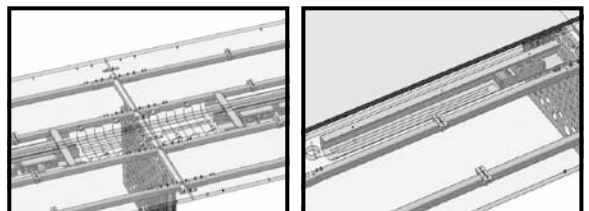

Accessori per elettrificazione
Cable management accessories
Accessoires pour le passage de câbles

ELEMENTO

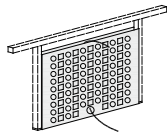

DESCRIZIONE

Coppia carter per gamba cavalletto centrale FLY01 cm. 80 – 124 - 164
Pair of covers for FLY01 central trestle leg 80 – 124 - 164 cm
Couple de carters pour piétement intermédiaire FLY01 80 - 124 - 164 cm.

		Metallo / Metal / Métal					
MISURA	CODICE	W	Y				
72x65	56571	226,00	226,00				

ELEMENTO

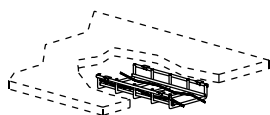

DESCRIZIONE

Cestello raccogli cavi (da applicare sotto il piano scrivania).
N.b.: non utilizzare come supporto per prese precablate o scatole di elettrificazione in genere
Cable collection tray (to be applied under the desktop).
Not: do not use as support for pre-cabled outlets or electrification boxes in general
Panier de rangement des câbles (à appliquer sous le plateau du bureau).
NB: Ne pas utiliser comme support pour les prises pré-câblées ou pour les boîtes d'électrification en général

		Metallo / Metal / Métal					
MISURA	CODICE	W	Y				
30x30	56574	81,00	81,00				

ELEMENTO

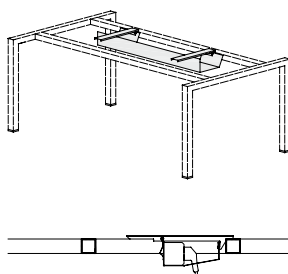

DESCRIZIONE

Vaschetta di elettrificazione per scrivanie con piani singoli
La vaschetta è ispezionabile e permette l'inserimento di 2 scatole di elettrificazione.
N.B.: non utilizzabile nelle scrivanie con profondità cm.60
N.B.: non utilizzabile nelle scrivanie singole del programma FLY02 con larghezza inferiore a mm.1400
Electrification tray for desks with single worktop.
The tray can be inspected and allows the insertion of 2 electrification boxes.
Note: cannot be used on 60 cm deep desks
Note: cannot be used in FLY02 programme single desks with width less than 1400 mm
Conteneur pour l'électrification des bureaux à plateaux individuels
Le conteneur peut être inspecté et peut contenir 2 boîtes d'électrification.
Remarque: Ne pas utiliser sur les bureaux de 60 cm de profondeur.
Note: Ne pas utiliser sur les bureaux individuels du programme FLY02 dont la largeur est inférieure à 1400 mm.

		Metallo / Metal / Métal					
MISURA	CODICE	Y					
80x16	56572	167,00					

FLY 01/02/03

Accessori per elettrificazione
 Cable management accessories
 Accessoires pour le passage de câbles

ELEMENTO

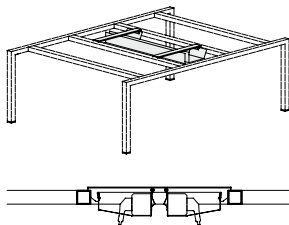

DESCRIZIONE

**Coppia vaschette di elettrificazione per scrivanie con piani contrapposti .
 Ogni vaschetta è ispezionabile singolarmente e permette l'inserimento di 2 scatole di
 elettrificazione per ognuna di esse.**

**N.B.: Può essere utilizzata anche nella coppia piani laterali con profondità cm.124 e
 larghezza cm.100 (art. 52002 - 52006)**

Pair of electrification trays for desks with opposing worktops.

Each tray can be inspected individually and allows the insertion of 2 electrification
 boxes for each one of them.

N.B: Can also be used in pairs of 124 and 100 cm deep side worktops (Art. 52002 -
 52006)

Couple de conteneurs pour l'électrification des bureaux face-à-face.

Chaque conteneur peut être inspecté et peut contenir 2 boîtes d'électrification.

N.B.: Il peut également être utilisé avec le couple de parements latéraux de 124 cm de
 profondeur et de 100 cm de largeur (art. 52002 - 52006)

		Metallo / Metal / Métal					
MISURA	CODICE	Y					
80x40	56573	310,00					

Contenitori strutturali 03/2016

Structural cabinets 03/2016

Armoires structurelles 03/2016

Informazioni

Information
Informations

3 Caratteristiche tecniche

Technical details
Caractéristiques techniques

6 Peso, volume, colli

Weight, volume, packages
Poids, volume, colis

7 Abbinamenti colore e come ordinare

Colour matching and how to order
Association coloris et comment passer la commande

10 Esplicativo contenitori strutturali

Bearing storage units details
Détails des armoires porteuses

16 Esplicativo sistemi di elettrificazione

Cable management details
Détails du passage de câbles

17 Contenitori strutturali

Bearing storage units
Armoires porteuses

22 Accessori per contenitori strutturali

Bearing storage units accessories
Accessoires des armoires porteuses



Caratteristiche fisico-meccaniche dei pannelli in nobilitato melaminico

Emissione di formaldeide: E1.

Spessori: cm 1,8 – 2,8

Densità: kg 660 (+ -3%) mc (DIN 68763/81).

Contenitori strutturali

Struttura

Nobilitato melaminico di qualità E1.

Spessore cm 1,8 – 2,8

Dotati di piedini di livellamento in plastica ed acciaio

Colori: **G** Grigio chiaro - **W** Bianco – **RC** Rovere chiaro -

NA Noce Ambra - **WE** Wengè - **Z** Alluminio gofrato

Parti frontali

Nobilitato melaminico di qualità E1.

Spessore cm 1,8 con bordo ABS su tutti i lati.

Ante dotate di serratura e cerniere con apertura 110°

Colori: **G** Grigio chiaro - **W** Bianco – **RC** Rovere chiaro -

NA Noce Ambra - **WE** Wengè - **Z** Alluminio gofrato

Piani compensatori

Nobilitato melaminico di qualità E1.

Spessore cm 1,8 – 2,8 con bordo ABS su tutti i lati.

Colori: **G** Grigio chiaro - **W** Bianco – **RC** Rovere chiaro -

NA Noce Ambra - **WE** Wengè

Top

Nobilitato melaminico di qualità E1.

Spessore cm 1,8 – 2,8 con bordo ABS su tutti i lati.

Colori: **G** Grigio chiaro - **W** Bianco – **RC** Rovere chiaro -

NA Noce Ambra - **WE** Wengè - **Z** Alluminio gofrato

Maniglie

Plastica: in ABS stampato in finitura Alluminio RAL9006

Metallo: in alluminio pressofuso con finitura Cromato.

Struttura metallo gamba Cavalletto

Tubolare di acciaio a sezione quadrata 4X4

spessore 20/10

Colori: **W** Bianco RAL9003 – **Y** Alluminio Lucido - **EQ**

Ecocromo

Physical-mechanical characteristics of the melamine panels

Level of emission of formaldehyde: E1

Thickness: 1.2 – 2.8 cm.

Density: 660 kg (± 3%) cu.m. (DIN68763/81).

Bearing storage units

Structure

E1 quality melamine.

Thickness: 1.2 – 2.8 cm.

Adjustable plastic and steel feet.

Colours: **G** Light grey - **W** White – **RC** Light oak – **NA**

Ambra walnut - **WE** Wengé –**Z** Embossed aluminium

Front

E1 quality melamine.

Thickness: 1.8 cm with ABS rounded, impact-resistant edges on all sides 110° open hinges

Colours: **G** Light grey - **W** White – **RC** Light oak – **NA**

Ambra walnut - **WE** Wengé –**Z** Embossed aluminium

Compensator worktops

E1 quality melamine.

Thickness: 1.8 cm with ABS rounded, impact-resistant edges on all sides 110° open hinges

Colours: **G** Light grey - **W** White – **RC** Light oak – **NA**

Ambra walnut - **WE** Wengé

Top

E1 quality melamine.

Thickness: 1.8 – 2.8 cm with ABS rounded, impact-resistant edges on all sides

Colours: **G** Light grey - **W** White – **RC** Light oak – **NA**

Ambra walnut - **WE** Wengé -**Z** Embossed aluminium

Handles

Plastic: in moulded ABS in RAL9006 Aluminium finish

Metal: in die-cast aluminium with Chromium finish

Metal structure trestle leg

Square 4x4 sections of tubular steel, 20/10 thick, bent and welded.

Colours: **W** RAL9003 White –**Y** Polished Aluminium – **EQ**

Eco-chrome

Caractéristiques physico-mécaniques des panneaux en mélamine

Emission de formaldéhyde: E1.

Épaisseur: 1,8 - 2,8 cm.

Densité: 660 kg (± 3%) m³ (DIN 68763/81).

Armoires structurelles

Structure en mélamine de qualité E1.

Épaisseur 1,8 – 2,8 cm.

Pieds réglables en plastique pigmentée et acier.

Couleurs: **G** Gris clair - **W** Blanc - **FG** Gris Fango -

RC Chêne clair – **NA** Noyer Ambra - **WE** Wengé – **Z**

Aluminium gaufré

Panneau frontal

Mélamine de qualité E1.

Épaisseur 1,8 cm avec chant en ABS arrondi

antichoc sur 4 côtés.

Charnières pour ouverture 100°

Couleurs: **G** Gris clair - **W** Blanc - **FG** Gris Fango -

RC Chêne clair – **NA** Noyer Ambra - **WE** Wengé – **Z**

Aluminium gaufré

Plateaux compensateurs

Mélamine de qualité E1.

Épaisseur 1,8 – 2,8 cm avec chant en ABS arrondi

antichoc sur 4 côtés.

Couleurs: **G** Gris clair - **W** Blanc - **FG** Gris Fango - **RC**

Chêne clair – **NA** Noyer Ambra - **WE** Wengé

Tops

Mélamine de qualité E1.

Épaisseur 1,8 – 2,8 cm avec chant en ABS arrondi

antichoc sur 4 côtés.

Couleurs: **G** Gris clair - **W** Blanc - **FG** Gris Fango -

RC Chêne clair – **NA** Noyer Ambra - **WE** Wengé – **Z**

Aluminium gaufré

Poignées

Plastique: ABS finition Aluminium RAL9006

Métal: aluminium moulé sous pression finition chromée

Structure en métal piètement

Tube d'acier à section carrée 4X4 épaisseur 20/10 plié et soudé.

Couleurs: **W** Blanc RAL9003 - **Y** Aluminium poli - **EQ** Eco

Chrome

Peso, volume, colli
Weight, volume, packages
Poids, volume, colis

Codice Code Code	Peso Weight Poids kg	Volume Volume Volume m³	Colli Packages Colis n°	Codice Code Code	Peso Weight Poids kg	Volume Volume Volume m³	Colli Packages Colis n°
231	0,3	0,003	2	56751	52,1	0,129	8
232	0,1	0,001	1	56752	38,21	0,07	6
233	0,1	0,001	1	56753	45,51	0,083	6
234	0,1	0,001	3	56761	3,8	0,004	1
56710	22,1	0,039	4	56762	4,7	0,006	1
56711	26,9	0,048	4	56763	5,3	0,007	1
56712	28,7	0,07	7	56764	6,7	0,009	1
56713	29	0,079	7	56766	3,8	0,004	1
56714	35,5	0,087	7	56767	4,7	0,006	1
56715	35,8	0,096	7	56768	5,3	0,007	1
56716	24,2	0,041	5	56769	6,7	0,009	1
56717	29,3	0,05	5	56771	3,8	0,004	1
56720	33,2	0,058	5	56772	4,7	0,006	1
56721	40,3	0,07	5	56773	6,6	0,008	1
56722	39,8	0,089	8	56774	7,4	0,01	1
56723	40,1	0,098	8	56775	8,3	0,011	1
56724	48,9	0,109	8	56776	9,3	0,013	1
56725	49,2	0,118	8	56777	10,2	0,014	1
56726	33,61	0,058	5	56778	11,1	0,015	1
56727	40,61	0,07	5	56779	12	0,017	1
56728	35,1	0,082	7	56781	5,3	0,007	1
56729	35,4	0,091	7	56782	6,7	0,009	1
56730	42,7	0,1	7	56783	9,7	0,013	1
56731	43	0,109	7	56784	11	0,015	1
56732	30,41	0,053	5	56785	12,4	0,017	1
56733	36,41	0,063	5	56786	14	0,02	1
56740	44,1	0,079	5	56787	15,3	0,022	1
56741	53,5	0,095	5	56788	16,7	0,024	1
56742	50,7	0,11	8	56789	18	0,026	1
56743	51	0,119	8	56791	1	0,001	1
56744	62,1	0,134	8	56792	1,5	0,001	1
56745	62,4	0,143	8	56793	2,5	0,002	1
56746	44,61	0,079	5	56794	3	0,002	1
56747	53,81	0,095	5				
56748	42,8	0,099	8				
56749	43,1	0,108	8				
56750	51,8	0,12	8				

Abbinamenti colore e come ordinare
Colour matching and how to order
Association coloris et comment passer la commande

8 Contenitori strutturali
Bearing storage units
Armoires porteuses

Contenitori strutturali

Bearing storage units

Armoires porteuses

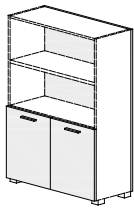

Frontale/schiena
Front/back
Panneau frontal/dos

G Grigio chiaro
Light grey
Gris clair

W Bianco
White
Blanc

RC Rovere chiaro
Light oak
Chêne clair

NA Noce Ambra
Ambra walnut
Noyer Ambra

WE Wenge
Wenge
Wengé

Z Alluminio gofrato
Embossed aluminium
Aluminium gaufré

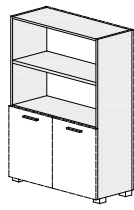

Struttura
Structure
Structure

G Grigio chiaro
Light grey
Gris clair

W Bianco
White
Blanc

RC Rovere chiaro
Light oak
Chêne clair

NA Noce Ambra
Ambra walnut
Noyer Ambra

WE Wenge
Wenge
Wengé

Z Alluminio gofrato
Embossed aluminium
Aluminium gaufré

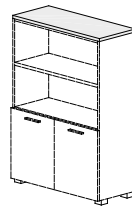

Top
Top
Top

G Grigio chiaro
Light grey
Gris clair

W Bianco
White
Blanc

RC Rovere chiaro
Light oak
Chêne clair

NA Noce Ambra
Ambra walnut
Noyer Ambra

WE Wenge
Wenge
Wengé

Z Alluminio gofrato
Embossed aluminium
Aluminium gaufré

Per una corretta compilazione dell'ordine bisogna indicare:

- colore frontali
- codice prodotto
- colore struttura

Esempio:
Contenitore strutturale L.80,4 – H.70,2 cm con frontale/schiena in nobilitato bianco e struttura in nobilitato bianco e maniglia in plastica RAL9006

- Sigla colore frontale/schiena **W**
- Codice prodotto **56714**
- Sigla colore struttura **W**

To fill-in the order must indicate:

- front colour
- product code
- structure colour

Example:
Bearing storage L.80.4 – H.70.2 cm with white melamine front/back and white melamine structure, RAL 9006 plastic handle

- Front/back colour code **W**
- Product code **56714**
- Structure colour code **W**

Pour rédiger la commande il faut indiquer:

- coloris panneau frontal
- code produit
- coloris structure

Exemple:
Armoire porteuse Etagère L.80,4 – H.70,2 cm avec panneau frontal/dos en mélamine blanc et structure en mélamine blanc, poignée en plastique RAL 9006

- Code coloris panneau frontal/dos **W**
- Code produit **56714**
- Code coloris structure **W**

Esplicativo contenitori strutturali
Bearing storage units details
Détails des armoires porteuses

ELEMENTO

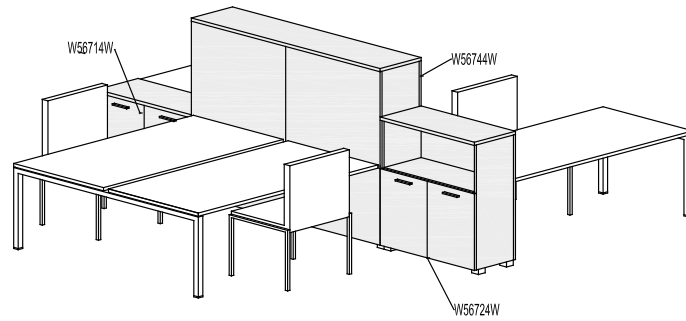
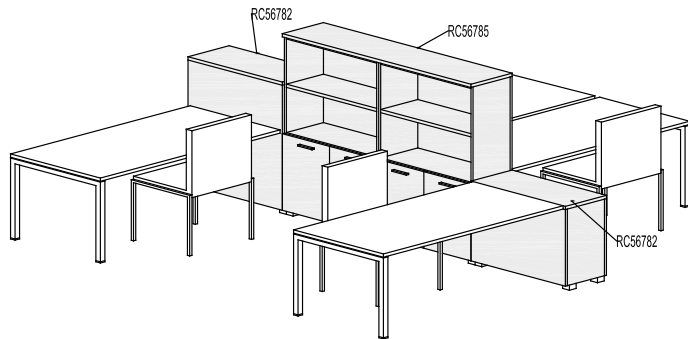
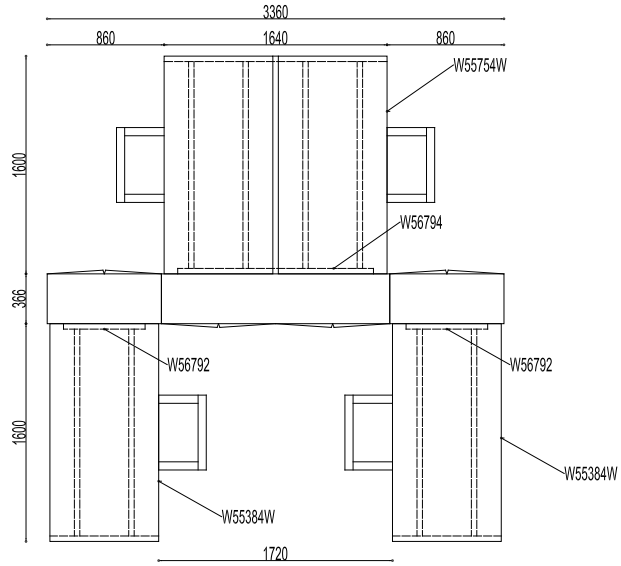

FLY 01/02/03

Esplicativo contenitori strutturali
 Bearing storage units details
 Détails des armoires porteuses

QUANTITÀ QUANTITY QUANTITÉ	CODICE ARTICOLO ARTICLE CODE CODE DE L'ARTICLE	DESCRIZIONE DESCRIPTION DESCRIPTION
Nr.1	W56714W	Contenitore strutturale H70.2x84 cm con frontali,schiena e struttura in nobilitato bianco e maniglia in plastica RAL9006 H70.2x84 cm bearing storage unit with with melamine front, back and structure and RAL 9006 plastic handle Armoire porteuse H70.2x84 cm avec Panneaux frontaux, dos et structure en mélamine blanc et poignée en plastique RAL 9006
Nr.1	W56724W	Contenitore strutturale H111.8x84 cm con frontali e schienale intero. Frontali,schiena,struttura in nobilitato bianco con maniglia in plastica RAL9006 H111.8x84 cm bearing storage unit with front and internal back. White melamine front panels, back and structure and RAL 9006 plastic handle. Armoire porteuse H111.8x84 cm avec Panneaux frontaux et dos interne. Panneaux frontaux, dos et structure en mélamine blanc avec poignée RAL 9006
Nr.2	W56744W	Contenitore strutturale H153.4x84 cm con frontali e schienale intero. Frontali,schiena,struttura in nobilitato bianco con maniglia in plastica RAL9006 H153.4x84cm bearing storage unit with front and internal back. White melamine front panels, back and structure and RAL 9006 plastic handle. Armoire porteuse H153.4x84cm avec Panneaux frontaux et dos interne. Panneaux frontaux, dos et structure en mélamine blanc avec poignée RAL 9006
Nr.2	RC56782	Top per contenitore strutturale L.84 spessore cm 2,8 in nobilitato rovere chiaro L.84 bearing storage unit top, thickness cm 2.8 light oak melamine Top pour armoire porteuse L.84, mélaminé chêne clair épaisseur 2,8 cm
Nr.1	RC56785	Top per contenitore strutturale L.168 spessore cm 2,8 in nobilitato rovere chiaro L.84 bearing storage unit top, thickness cm 2.8 light oak melamine Top pour armoire porteuse L.84, mélaminé chêne clair épaisseur 2,8 cm
Nr.2	W56792	Cavalletto strutturale cm 80 bianco RAL9003 per fissaggio scrivani ai contenitori 80 cm white bearing trestle for fixing desk to the storage units Pied tréteau80 cm blanc RAL 9003 pour fixation bureaux aux armoires
Nr.1	W56794	Cavalletto strutturale cm 164 bianco RAL9003 per fissaggio scrivanie ai contenitori 164 cm white bearing trestle for fixing desk to the storage units Pied tréteau164 cm blanc RAL 9003 pour fixation bureaux aux armoires
Nr.2	W55384W	Tavolo iniziale/finale FLY01 cm160x80 con piano singolo in nobilitato bianco spessore 2,8 cm, e cavalletto bianco RAL9003 FLY01 160x80 cm start/end single desk, thickness 2.8 cm white melamine and RAL 9003 white trestle Bureau initial/final FLY01 cm160x80 avec plateau simple mélaminé blanc, épaisseur 2,8 cm et piètement blanc RAL 9003
Nr.1	W55754W	Tavolo iniziale/finale FLY01 cm160x164 con piano singolo in nobilitato bianco spessore 2,8 cm, e cavalletto bianco RAL9003 FLY01 160x164 cm start/end single desk, thickness 2.8 cm white melamine and RAL 9003 white trestle Bureau initial/final FLY01 cm160x164 avec plateau simple mélaminé blanc, épaisseur 2,8 cm et piètement blanc RAL 9003

Esplicativo contenitori strutturali
Bearing storage units details
Détails des armoires porteuses

ELEMENTO

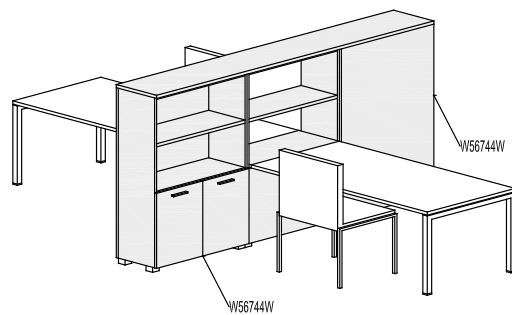
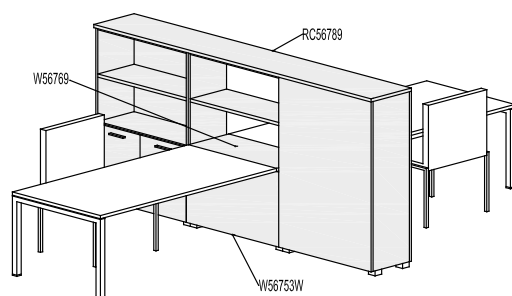
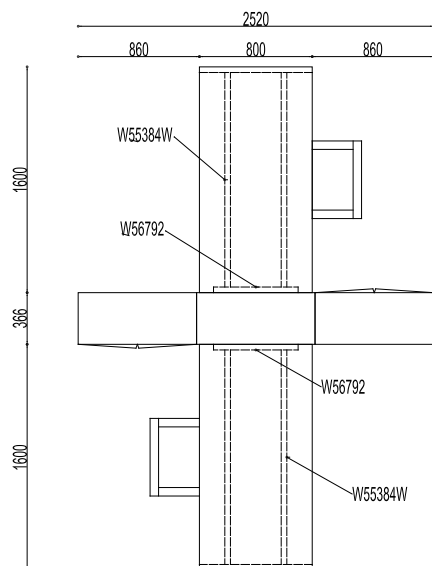

FLY 01/02/03

Esplicativo contenitori strutturali
 Bearing storage units details
 Détails des armoires porteuses

QUANTITÀ QUANTITY QUANTITÉ	CODICE ARTICOLO ARTICLE CODE CODE DE L'ARTICLE	DESCRIZIONE DESCRIPTION DESCRIPTION
Nr.2	W56744W	Contenitore strutturale H153.8x84 cm con frontali e schienale intero. Frontali,schiena,struttura in nobilitato bianco con maniglia in plastica RAL9006 H153.4x84cm bearing storage unit with front and internal back. White melamine front panels, back and structure and RAL 9006 plastic handle. Armoire porteuse H153.4x84cm avec Panneaux frontaux et dos interne. Panneaux frontaux, dos et structure en mélamine blanc avec poignée RAL 9006.
Nr.1	W56753W	Contenitore strutturale H153.4x84 cm con schienali bassi. Frontali,schiena,struttura in nobilitato bianco con maniglia in plastica RAL9006 H153.4x84cm bearing storage unit with low backs. White melamine front panels, back and structure and RAL 9006 plastic handle. Armoire porteuse H153.4x84cm avec dos bas. Panneaux frontaux, dos et structure en mélamine blanc avec poignée RAL 9006.
Nr.1	W56769	Piano compensatore in nobilitato bianco spessore cm 2,8 per scrivanie centrali Thicknesses 2.8 cm White melamine compensator worktop for central desks Plateau compesateur en mélamine blanc épaisseur 2,8 cm pour bureaux centraux
Nr.1	RC56789	Top per contenitore strutturale L.252 spessore cm 2,8 in nobilitato rovere chiaro L.252 bearing storage unit top, thickness cm 2.8 light oak melamine Top pour armoire porteuse L.252, mélaminé chêne clair épaisseur 2,8 cm
Nr.2	W56792	Cavalletto strutturale cm 80 bianco RAL9003 per fissaggio scrivani ai contenitori 80 cm white bearing trestle for fixing desk to the storage units Pied tréteau80 cm blanc RAL 9003 pour fixation bureaux aux armoires
Nr.2	W55384W	Tavolo iniziale/finale FLY01 cm160x80 con piano singolo in nobilitato bianco spessore 2,8 cm, e cavalletto bianco RAL9003 FLY01 160x80 cm start/end single desk, thickness 2.8 cm white melamine and RAL 9003 white trestle Bureau initial/final FLY01 cm160x80 avec plateau simple mélaminé blanc, épaisseur 2,8 cm et piètement blanc RAL 9003

Esplicativo contenitori strutturali
 Bearing storage units details
 Détails des armoires porteuses

ELEMENTO

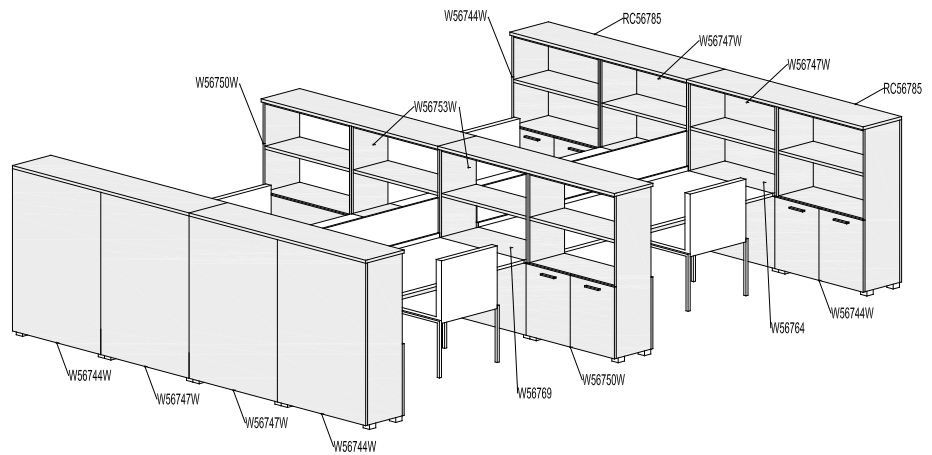
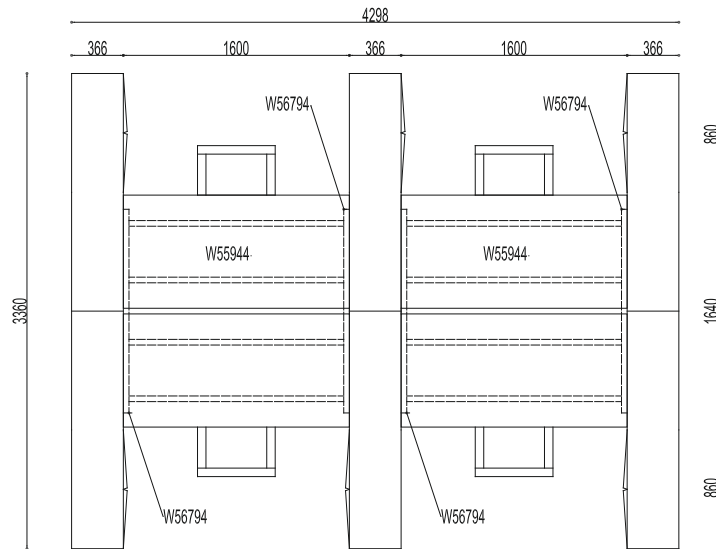

FLY 01/02/03

Esplicativo contenitori strutturali
 Bearing storage units details
 Détails des armoires porteuses

QUANTITÀ QUANTITY QUANTITÉ	CODICE ARTICOLO ARTICLE CODE CODE DE L'ARTICLE	DESCRIZIONE DESCRIPTION DESCRIPTION
Nr.4	W56744W	Contenitore strutturale H153.8x84 cm con frontali e schienale intero. Frontali,schiena,struttura in nobilitato bianco con maniglia in plastica RAL9006 H153.4x84cm bearing storage unit with front and internal back. White melamine front panels, back and structure and RAL 9006 plastic handle. Armoire porteuse H153.4x84cm avec Panneaux frontaux et dos interne. Panneaux frontaux, dos et structure en mélamine blanc avec poignée RAL 9006.
Nr.4	W56747W	Contenitore strutturale H153.4x84 cm con schienali bassi. Schiene e struttura in nobilitato bianco con maniglia in plastica RAL9006 H153.4x84cm bearing storage unit 2 backs. White melamine backs and structure and RAL 9006 plastic handle. Armoire porteuse H153.4x84cm avec 2 dos. Dos et structure en mélamine blanc avec poignée RAL 9006.
Nr.2	W56750W	Contenitore strutturale H153.4x84 cm con frontali e schienale basso. Fontali, schiene e struttura in nobilitato bianco con maniglia in plastica RAL9006 H153.4x84 cm bearing storage unit front panels and low back. White melamine front, back and structure and RAL 9006 plastic handle. Armoire porteuse H153.4x84cm avec panneau frontal e dos bas. Panneaux frontaux, dos et structure en mélamine blanc avec poignée RAL 9006.
Nr.2	W56753W	Contenitore strutturale H153.4x84 cm con schienali bassi. Frontali,schiena,struttura in nobilitato bianco con maniglia in plastica RAL9006 H153.4x84cm bearing storage unit with low backs. White melamine front panels, back and structure and RAL 9006 plastic handle. Armoire porteuse H153.4x84cm avec dos bas. Panneaux frontaux, dos et structure en mélamine blanc avec poignée RAL 9006.
Nr.4	W56764	Piano compensatore in nobilitato bianco spessore cm 2,8 per scrivanie terminali Thickneses 2.8 cm White melamine compensator worktop for end desks Plateau compesateur en mélamine blanc épaisseur 2,8 cm pour bureaux terminales
Nr.2	W56769	Piano compensatore in nobilitato bianco spessore cm 2,8 per scrivanie centrali Thickneses 2.8 cm White melamine compensator worktop for central desks Plateau compesateur en mélamine blanc épaisseur 2,8 cm pour bureaux centraux
Nr.6	RC56785	Top per contenitore strutturale L.168 spessore cm 2,8 in nobilitato rovere chiaro L.84 bearing storage unit top, thickness cm 2.8 light oak melamine Top pour armoire porteuse L.84, mélaminé chêne clair épaisseur 2,8 cm
Nr.4	W56794	Cavalletto strutturale cm 164 bianco RAL9003 per fissaggio scrivanie ai contenitori 164 cm white bearing trestle for fixing desk to the storage units Pied tréteau164 cm blanc RAL 9003 pour fixation bureaux aux armoires
Nr.2	W55944	Piani contrapposti CENTRALE cm160x80 spessore 2,8 cm, in nobilitato bianco e cavalletto bianco RAL9003 160x80 cm central worktops, white melamine thickness 2.8 cm and RAL 9003 white trestle Bureaux centraux face-à-face cm 160x80 mélaminé blanc épaisseur 2,8 cm et piètement blanc RAL 9003

Il sistema di elettrificazione consiste nell'applicare sul basamento dei contenitori strutturali una struttura di canaline in plastica ispezionabili con suddivisione interna in 3 scomparti (distanza pavimento/basamento mobili = 44mm).

La risalita al piano avviene tramite l'apposito modulo verticale, completo di raccordo 90° tra le canaline. In alternativa, può essere utilizzata la vertebra di risalita cavi.

Per l'elettrificazione sul piano utilizzare i vari sistemi previsti nel programma FLY.

The cable management system applicable to the base of the bearing storage units is composed of an openable plastic raceway which is divided into 3 internal compartments (distance floor-storage unit = 44mm).

The vertical cable management to the worktop consists of a dedicated module, complete with 90° fitting between raceways. Alternatively, it is possible to use the vertebra.

For the electrification of the worktop use systems available for the FLY range.

Le système d'électrification est formé de goulottes en plastique appliquées sous le fond de la structure des armoires. Les goulottes sont avec ouverture et avec trois compartiments à l'intérieur. (distance sol/base de l'armoire = 44mm).

La remontée verticale sur le plateau est effectuée en utilisant le module vertical, avec ajustement de 90° entre les goulottes. Comme alternative, on peut utiliser la vertèbre.

Pour l'électrification du plateau utiliser les différents systèmes du programme FLY.

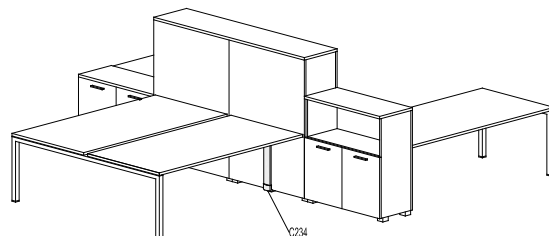
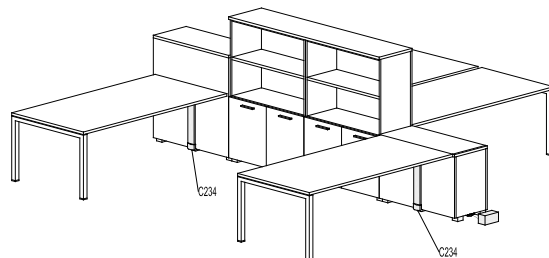
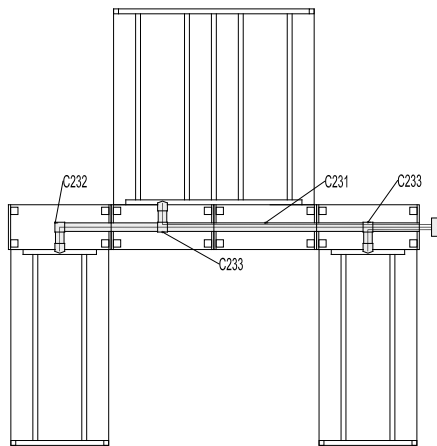

ELEMENTO

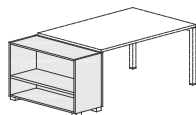

DESCRIZIONE

Contenitore a giorno (ordinare top)

Open storage unit (order top)

Armoire visible (commander top)

		Nobilitato / Melamine / M�elamine		
MISURA	CODICE	G	W - RC - NA - WE - Z	
64x34,8	56710	171,00	182,00	
84x34,8	56711	181,00	194,00	

ELEMENTO

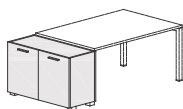

DESCRIZIONE

Contenitore con ante e 1 ripiano (ordinare top)

Storage unit with doors and 1 shelf (order top)

Armoire avec portes et tablette (commander top)

CON SERRATURA
 WITH LOCK
 AVEC SERRURE

	MISURA	CODICE	G	W - RC - NA - WE - Z	
MANIGLIA IN PLASTICA RAL 9006 RAL 9006 PLASTIC HANDLE POIGNEE EN PLASTIQUE RAL 9006	64x36,6	56712	285,00	302,00	
MANIGLIA IN METALLO ECOCROMO ECO-CHROME METAL HANDLE POIGNEE EN METAL ECO CHROME	64x36,6	56713	293,00	310,00	
MANIGLIA IN PLASTICA RAL 9006 RAL 9006 PLASTIC HANDLE POIGNEE EN PLASTIQUE RAL 9006	84x36,6	56714	300,00	318,00	
MANIGLIA IN METALLO ECOCROMO ECO-CHROME METAL HANDLE POIGNEE EN METAL ECO CHROME	84x36,6	56715	307,00	326,00	

		Nobilitato / Melamine / M�elamine		
MISURA	CODICE	G	W - RC - NA - WE - Z	
64x36,6	56712	285,00	302,00	
64x36,6	56713	293,00	310,00	
84x36,6	56714	300,00	318,00	
84x36,6	56715	307,00	326,00	

ELEMENTO

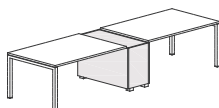

DESCRIZIONE

Contenitore completo di 2schienali per composizioni con scrivanie contrapposte (ordinare top)**N.B.: vano interno del mobile non accessibile**

Storage unit with 2 back panels for opposed desks (order top)

NOTE: the internal space of the storage unit is not accessible

Armoire avec 2 dos pour bureaux oppos es (commander top)

NOTE : la partie interne de l'armoire n'est pas accessible

		Nobilitato / Melamine / M�elamine		
MISURA	CODICE	G	W - RC - NA - WE - Z	
64x36,6	56716	195,00	210,00	
84x36,6	56717	206,00	223,00	

ELEMENTO

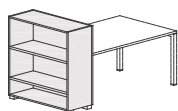

DESCRIZIONE

Contenitore a giorno (ordinare top)

Open storage unit (order top)

Armoire visible (commander top)

		Nobilitato / Melamine / M�elamine		
MISURA	CODICE	G	W - RC - NA - WE - Z	
64x34,8	56720	225,00	239,00	
84x34,8	56721	241,00	257,00	

ELEMENTO

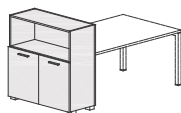

DESCRIZIONE

Contenitore con ante, 1 ripiano eschienale intero (ordinare top)

Storage unit with doors, 1 shelf and internal back (order top)

Armoire avec portes, 1 tablette et dos interne (commander top)

CON SERRATURA
WITH LOCK
AVEC SERRURE

MANIGLIA IN PLASTICA RAL 9006
RAL 9006 PLASTIC HANDLE
POIGNEE EN PLASTIQUE RAL 9006

MANIGLIA IN METALLO ECOCROMO
ECO-CHROME METAL HANDLE
POIGNEE EN METAL ECO CHROME

MANIGLIA IN PLASTICA RAL 9006
RAL 9006 PLASTIC HANDLE
POIGNEE EN PLASTIQUE RAL 9006

MANIGLIA IN METALLO ECOCROMO
ECO-CHROME METAL HANDLE
POIGNEE EN METAL ECO CHROME

		Nobilitato / Melamine / M�elamine		
MISURA	CODICE	G	W - RC - NA - WE - Z	
64x36,6	56722	340,00	359,00	
64x36,6	56723	347,00	367,00	
84x36,6	56724	361,00	381,00	
84x36,6	56725	367,00	388,00	

ELEMENTO

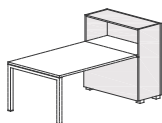

DESCRIZIONE

Contenitore con 2 schienali (ordinare piano compensatore per scrivanie terminali e top)**N.B.: vano interno del mobile non accessibile**

Storage unit with 2 back panels (order compensator worktop for end desks and top)

NOTE: the internal space of the storage unit is not accessible

Armoire avec 2 dos (commander plateau compensateur pour bureau terminaux et top)

NOTE : la partie interne de l'armoire n'est pas accessible

		Nobilitato / Melamine / M�elamine		
MISURA	CODICE	G	W - RC - NA - WE - Z	
64x36,6	56726	242,00	261,00	
84x36,6	56727	257,00	278,00	

ELEMENTO

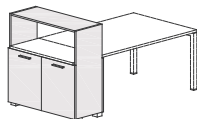

DESCRIZIONE

Contenitore schienale basso con ante e 1 ripiano (ordinare piano compensatore per scrivanie centrali e top)

Low back storage unit with doors and 1 shelf (order compensator worktop for central desks and top)

Armoire dos bas avec portes et tablette (commander plateau compensateur pour bureaux centraux et top)

CON SERRATURA
 WITH LOCK
 AVEC SERRURE

		Nobilitato / Melamine / M�elamine		
MISURA	CODICE	G	W - RC - NA - WE - Z	
MANIGLIA IN PLASTICA RAL 9006 RAL 9006 PLASTIC HANDLE POIGNEE EN PLASTIQUE RAL 9006	64x36,6 56728	319,00	339,00	
MANIGLIA IN METALLO ECOCROMO ECO-CHROME METAL HANDLE POIGNEE EN METAL ECO CHROME	64x36,6 56729	327,00	347,00	
MANIGLIA IN PLASTICA RAL 9006 RAL 9006 PLASTIC HANDLE POIGNEE EN PLASTIQUE RAL 9006	84x36,6 56730	335,00	357,00	
MANIGLIA IN METALLO ECOCROMO ECO-CHROME METAL HANDLE POIGNEE EN METAL ECO CHROME	84x36,6 56731	343,00	365,00	

ELEMENTO

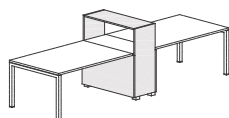

DESCRIZIONE

Contenitore con 2 schienali bassi per composizioni con scrivanie contrapposte (ordinare piano compensatore per scrivanie centrali e top)

N.B.: vano interno del mobile non accessibile

Storage unit with 2 low backs for opposing desks (order compensator worktop for central desks and top)

NOTE: the internal space of the storage unit is not accessible

Armoire avec 2 dos bas pour bureaux oppos ees (commander platea compesateur pour bureaux centraux et top)

NOTE : la partie interne de l'armoire n'est pas accessible

		Nobilitato / Melamine / M�elamine		
MISURA	CODICE	G	W - RC - NA - WE - Z	
64x36,6	56732	232,00	249,00	
84x36,6	56733	244,00	264,00	

ELEMENTO

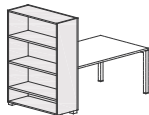

DESCRIZIONE

Contenitore a giorno (ordinare top)

Open storage unit (order top)

Armoire visible (commander top)

		Nobilitato / Melamine / Mélamine		
MISURA	CODICE	G	W - RC - NA - WE - Z	
64x34,8	56740	274,00	291,00	
84x34,8	56741	296,00	314,00	

ELEMENTO

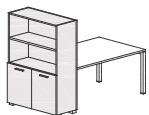

DESCRIZIONE

Contenitore schienale intero con ante e 2 ripiani (ordinare top)

Full back storage unit with doors and 2 shelves (order top)

Armoire dos complét avec portes et 2 tablettes (commander top)

CON SERRATURA
WITH LOCK
AVEC SERRURE

MANIGLIA IN PLASTICA RAL 9006
RAL 9006 PLASTIC HANDLE
POIGNEE EN PLASTIQUE RAL 9006

MANIGLIA IN METALLO ECOCROMO
ECO-CHROME METAL HANDLE
POIGNEE EN METAL ECO CHROME

MANIGLIA IN PLASTICA RAL 9006
RAL 9006 PLASTIC HANDLE
POIGNEE EN PLASTIQUE RAL 9006

MANIGLIA IN METALLO ECOCROMO
ECO-CHROME METAL HANDLE
POIGNEE EN METAL ECO CHROME

		Nobilitato / Melamine / Mélamine		
MISURA	CODICE	G	W - RC - NA - WE - Z	
64x36,6	56742	389,00	411,00	
64x36,6	56743	397,00	419,00	
84x36,6	56744	414,00	439,00	
84x36,6	56745	422,00	446,00	

ELEMENTO

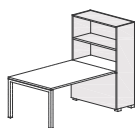

DESCRIZIONE

Contenitore con 2 schienali e 1 ripiano (ordinare piano compensatore per scrivanie terminali e top)**N.B.: vano interno del mobile non accessibile**

Storage unit with 2 backs and 1 shelf (order compensator worktop for end desks and top)

NOTE: the internal space of the storage unit is not accessible

Armoire avec 2 dos et 1 tablette (commander plateau compensateur pour bureaux terminaux et top)

NOTE : la partie interne de l'armoire n'est pas accessible

		Nobilitato / Melamine / Mélamine		
MISURA	CODICE	G	W - RC - NA - WE - Z	
64x36,6	56746	291,00	312,00	
84x36,6	56747	311,00	335,00	

H153.4

Contenitori strutturali (lo spessore del top è escluso dall'altezza indicata)

Bearing storage units (the thickness of the top is excluded from the indicated height)

Armoires porteuses (l'épaisseur du top n'est pas comprise dans la hauteur indiquée)

ELEMENTO

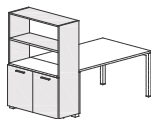

DESCRIZIONE

Contenitore schienale basso con ante e 2 ripiani (ordinare piano compensatore per scrivanie centrali e top)

Low back storage unit with doors and 2 shelves (order compensator worktop for central desks and top).

Armoire dos bas avec portes et 2 tablettes (commander plateau compensateur pour bureaux centraux et top)

CON SERRATURA
WITH LOCK
AVEC SERRURE

		Nobilitato / Melamine / Mèlamine		
MISURA	CODICE	G	W - RC - NA - WE - Z	
MANIGLIA IN PLASTICA RAL 9006 RAL 9006 PLASTIC HANDLE POIGNEE EN PLASTIQUE RAL 9006	64x36,6 56748	372,00	393,00	
MANIGLIA IN METALLO ECOCROMO ECO-CHROME METAL HANDLE POIGNEE EN METAL ECO CHROME	64x36,6 56749	380,00	401,00	
MANIGLIA IN PLASTICA RAL 9006 RAL 9006 PLASTIC HANDLE POIGNEE EN PLASTIQUE RAL 9006	84x36,6 56750	391,00	415,00	
MANIGLIA IN METALLO ECOCROMO ECO-CHROME METAL HANDLE POIGNEE EN METAL ECO CHROME	84x36,6 56751	399,00	422,00	

ELEMENTO

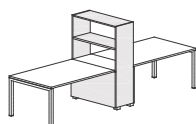

DESCRIZIONE

Contenitore con 2 schienali bassi e 1 ripiano per composizioni con scrivanie contrapposte (ordinare piano compensatore per scrivanie centrali e top)
N.B.: vano interno del mobile non accessibile

Storage unit with 2 low backs and 1 shelf for opposing desks (order compensator worktop and top)

NOTE: the internal space of the storage unit is not accessible

Armoire avec 2 dos bas et 1 tablette pour bureau opposées (commander plateau compensateur et top)

NOTE : la partie interne de l'armoire n'est pas accessible

		Nobilitato / Melamine / Mèlamine		
MISURA	CODICE	G	W - RC - NA - WE - Z	
64x36,6	56752	284,00	303,00	
84x36,6	56753	300,00	321,00	

Accessori per contenitori strutturali
 Bearing storage units accessories
 Accessoires pour armoires porteuses

ELEMENTO

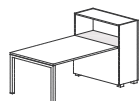

DESCRIZIONE

Piano compensatore per scrivanie terminali
 Compensator worktop for end desks
 Plateau compensateur pour bureaux terminaux

		Nobilitato sp 1,8 cm / Melamine th 1.8 cm / M é lamine é p 1,8 cm		
MISURA	CODICE	G	W - RC - NA - WE - Z	
60x34,8	56761	29,00	30,00	
80x34,8	56762	32,00	34,00	

		Nobilitato sp 2,8 cm / Melamine th 2.8 cm / M é lamine é p 2,8 cm		
MISURA	CODICE	G	W - RC - NA - WE - Z	
60x34,8	56763	33,00	35,00	
80x34,8	56764	38,00	40,00	

ELEMENTO

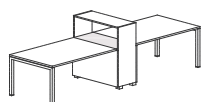

DESCRIZIONE

Piano compensatore centrale tra scrivanie
 Compensator worktop for units between desks
 Plateau compensateur central pour bureaux

		Nobilitato sp 1,8 cm / Melamine th 1.8 cm / M é lamine é p 1,8 cm		
MISURA	CODICE	G	W - RC - NA - WE - Z	
60x36,6	56766	29,00	30,00	
80x36,6	56767	32,00	34,00	

		Nobilitato sp 2,8 cm / Melamine th 2.8 cm / M é lamine é p 2,8 cm		
MISURA	CODICE	G	W - RC - NA - WE - Z	
60x36,6	56768	33,00	35,00	
80x36,6	56769	38,00	40,00	

FLY 01/02/03

Accessori per contenitori strutturali
 Bearing storage units accessories
 Accessoires pour armoires porteuses

ELEMENTO

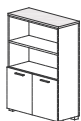

DESCRIZIONE

Top per contenitori
 Top for storage units
 Top pour armoires

Nobilitato sp 1,8 cm / Melamine th 1.8 cm / Mélangine ép 1,8 cm

MISURA	CODICE	G	W - RC - NA - WE - Z
64x36,6	56771	28,00	31,00
84x36,6	56772	32,00	35,00
128x36,6	56773	38,00	42,00
148x36,6	56774	42,00	47,00
168x36,6	56775	46,00	51,00
192x36,6	56776	50,00	56,00
212x36,6	56777	53,00	59,00
232x36,6	56778	57,00	63,00
252x36,6	56779	60,00	67,00

Nobilitato sp 2,8 cm / Melamine th 2.8 cm / Mélangine ép 2,8 cm

MISURA	CODICE	G	W - RC - NA - WE - Z
64x36,6	56781	28,00	31,00
84x36,6	56782	32,00	35,00
128x36,6	56783	38,00	42,00
148x36,6	56784	42,00	47,00
168x36,6	56785	46,00	51,00
192x36,6	56786	50,00	56,00
212x36,6	56787	53,00	59,00
232x36,6	56788	57,00	63,00
252x36,6	56789	60,00	67,00

Accessori per contenitori strutturali
 Bearing storage units accessories
 Accessoires pour armoires porteuses

ELEMENTO

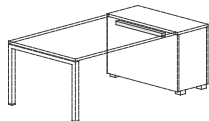

DESCRIZIONE

Cavalletto strutturale per fissaggio scrivanie singole FLY ai contenitori

Structural trestle for fixing FLY single desk to the storage units
 Piètement structural pour fixation bureaux simple FLY aux armoires

		Metallo / Metal / Métal		
MISURA	CODICE	Y	W	EQ
PROFONDITÀ CM.60 DEPTH CM.60 PROFONDEUR CM.60	56791	40,00	40,00	56,00
PROFONDITÀ CM.80 DEPTH CM.80 PROFONDEUR CM.80	56792	47,00	47,00	72,00

ELEMENTO

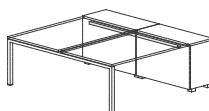

DESCRIZIONE

Cavalletto strutturale per fissaggio scrivanie contrapposte FLY ai contenitori

Structural trestle for fixing FLY opposed desks to the storage units
 Piètement structural pour fixation bureaux opposées FLY aux armoires

		Metallo / Metal / Métal		
MISURA	CODICE	Y	W	EQ
PROFONDITÀ CM.60 DEPTH CM.60 PROFONDEUR CM.60	56793	58,00	58,00	82,00
PROFONDITÀ CM.80 DEPTH CM.80 PROFONDEUR CM.80	56794	68,00	68,00	103,00

FLY 01/02/03

Accessori per contenitori strutturali
 Bearing storage units accessories
 Accessoires pour armoires porteuses

ELEMENTO

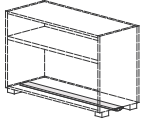

DESCRIZIONE

Canalina di elettrificazione lineare (viene fornita in barre da mt.2)
 Linear raceway for cable management (it is supplied in 2 metres bars)
 Goulotte linéaire pour remontée des câbles (fournie en barre de 2 metres)

		Accessori /Accessories / Accessoires		
MISURA	CODICE			
200x6	C231	46,00		

ELEMENTO

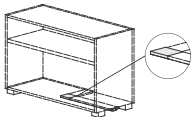

DESCRIZIONE

Raccordo a 2 vie per canaline di elettrificazione
 2 way junction for cable management raceways
 Jonction à 2 voies pour goulettes d'électrification

		Accessori /Accessories / Accessoires		
MISURA	CODICE			
6x6	C232	13,00		

Accessori per contenitori strutturali
 Bearing storage units accessories
 Accessoires pour armoires porteuses

ELEMENTO

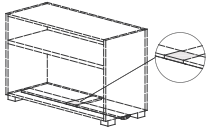

DESCRIZIONE

Raccordo a 3 vie per canaline di elettrificazione
 3 way junction for cable management raceways
 Jonction à 3 voies pour goulettes d'électrification

		Accessori / Accessories / Accessoires		
MISURA	CODICE			
6x7	C233	15,00		

ELEMENTO

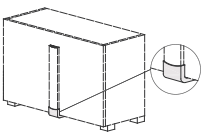

DESCRIZIONE

Raccordo 90° esterno completo di canalina di elettrificazione per risalita verticale
 90° external junction complete with vertical raceway
 Jonction externe complète de goulotte pour remontée de câbles

		Accessori / Accessories / Accessoires		
MISURA	CODICE			
100x6	C234	37,00		

FLY 01/02/03