

Informazioni

Information
Informations

- 3 **Caratteristiche tecniche**
4 Technical details
5 Caractéristiques techniques

- 6 **Peso, volume, colli**
Weight, volumes, packages
Poids, volume, colis

- 7 **Abbinamenti colore e come ordinare**
Colour matching and how to order
Association coloris et comment passer la commande

- 12 **Scrivanie serie "rettangolare"**
"Rectangular" series desks
Bureaux série "rectangulaire"

- 17 **Scrivanie serie "trapezio"**
"Trapezoidal" series desks
Bureaux série "trapézoïdale"

- 20 **Scrivanie serie "ovale"**
"Oval" series desks
Bureaux série "ovale"

- 22 **Tavoli riunione**
Meeting tables
Tables réunion

- 27 **Zona di attesa**
Waiting area
Zone d'accueil

- 28 **Modesty panels**
Modesty panels
Voiles de fond

- 29 **Cassettiere su ruote**
Drawer units on castors
Caissons sur roulettes

- 30 **Cassettiere portanti**
Bearing drawer units
Caissons porteurs

- 31 **Serventi**
Pedestals
Dessertes

- 33 **Boiserie**
Boiseries
Boiseries

Caratteristiche fisico-meccaniche dei pannelli in

Nobilitato melaminico

Emissione di formaldeide: E1.

Spessori: cm 1.2 – 1.8 – 2.8.

Densità: kg 660 (+ -3%) mc (DIN 68763/81).

Piani in nobilitato

Nobilitato melaminico di qualità E1.

Spessore: cm 3.8 con bordo ABS 20/10 stondato antiurto su tutti i lati del piano lavoro.

Colori: **RC** Rovere Chiaro - **WE** Wengè - **NA** Noce Ambra

Piani vetro

Vetro temperato e serigrafato, spessore cm 1,2.

Colori: **C** Trasparente - **S** Satinato - **KV** Nero - **WV** Bianco

Struttura metallo

Gamba alluminio goffrato

Estruso di alluminio con sezione Ø8 cm.

Piastre di attacco al piano e piedino di livellamento in pressofusione di alluminio.

Colori: **Z** Alluminio goffrato

Struttura nobilitato

Fianco rettangolare

Nobilitato melaminico di qualità E1.

Spessore: cm 3.8 con bordo ABS 20/10 stondato antiurto.

Piedi livellabili in ABS .

Profilo di attacco al piano in tubolare di acciaio con finitura cromata.

Colori: **RC** Rovere Chiaro - **WE** Wengè - **NA** Noce Ambra

Fianco sagomato

Nobilitato melaminico di qualità E1.

Spessore: cm 3.8 con bordo ABS 20/10 stondato antiurto.

Piedi livellabili in ABS.

Profilo di attacco al piano in tubolare di acciaio verniciato alluminio goffrato.

Colori: **RC** Rovere Chiaro - **WE** Wengè - **NA** Noce Ambra

Pannello

Nobilitato melaminico di qualità E1.

Spessore: cm 1.8 con bordo ABS 6/10.

Colori: **RC** Rovere Chiaro - **WE** Wengè - **NA** Noce Ambra

Modesty panel

Per piani nobilitato

Nobilitato melaminico di qualità E1.

Spessore: cm 1.5 con bordo ABS 13/10 stondato antiurto.

Colori: **RC** Rovere Chiaro - **WE** Wengè - **NA** Noce Ambra

Per piani vetro

Lamiera di acciaio spessore mm1,5 verniciata a polveri epossidiche.

Colori: **Z** Alluminio goffrato

Cassettiere su ruote, cassettiere portanti, serventi

Struttura

Nobilitato melaminico di qualità E1.

Spessore cm 1.8 – 2.8

Dotata di 4 ruote in plastica ed acciaio ad alta durata (cassettiera su ruote con schedario complete di 5° ruota) o di piedini di livellamento in plastica ed acciaio (cassettiere portanti – serventi).

Colori: **W** Bianco - **RC** Rovere Chiaro - **WE** Wengè - **NA** Noce Ambra

Parti frontali

Nobilitato melaminico di qualità E1.

Spessore cm 1.8 con bordo ABS su tutti i lati.

Frontali cassette dotati di serratura con chiusura simultanea.

Cassette interni in metallo completi di guide ad estrazione semplice (ad estrazione totale per cassetto schedario) e sistema antiribaltamento.

Colori: **W** Bianco - **RC** Rovere Chiaro - **WE** Wengè - **NA** Noce Ambra

Maniglie

Plastica: in ABS stampato in finitura Alluminio RAL9006

Metallo: in alluminio pressofuso con finitura Cromato.

Boiserie

Pannelli

Nobilitato melaminico di qualità E1.

Spessore: cm 1.8 con bordo ABS 6/10, corredati di profili in estruso di alluminio con finitura anodizzato naturale, predisposti per l'aggancio delle mensole.

Colori: **RC** Rovere Chiaro - **WE** Wengè - **NA** Noce Ambra

Profili per aggancio mensole / profilo terminale di finitura

Estruso di alluminio con finitura anodizzato naturale.

Mensole legno

Nobilitato melaminico di qualità E1.

Spessore cm 2.8 con bordo ABS 20/10 stondato antiurto.

Colori: **RC** Rovere Chiaro - **WE** Wengè - **NA** Noce Ambra

Mensole vetro

Vetro temperato spessore cm. 1.

Colori: **C** Trasparente - **S** Satinato - **KV** Nero - **WV** Bianco

Physical-mechanical characteristics of the melamine panels

Level of emission of formaldehyde: E1

Thickness: 1.2 – 1.8 – 2.8cm.

Density: 660kg (± 3%) cu.m. (DIN 68763/81)

Melamine worktops

E1 quality melamine.

3.8cm thick with 20/10 rounded shockproof ABS edging on all 4 sides.

Colours: **RC** Light oak - **WE** Wengé - **NA** Ambra walnut

Glass worktops

Tempered and screen printed glass. 1.2cm thick.

Colours: **C** Transparent - **S** Satined - **KV** Black - **WV** White

Metal structure

Embossed aluminium leg

Aluminium extrusion with 8cm diam. section.

Aluminium pressure die-casting plates for fixing to the worktop and adjustable feet.

Colours: **Z** Embossed aluminium

Melamine structure

Rectangular side panel

E1 quality melamine.

3.8cm thick with 20/10 rounded shockproof ABS edging.

Adjustable ABS feet.

Chrome-plated profile for fixing to the tubular steel worktop.

Colours: **RC** Light oak - **WE** Wengé - **NA** Ambra walnut

Shaped side panel

E1 quality melamine.

3.8cm thick with 20/10 rounded shockproof ABS edging.

Adjustable ABS feet.

Embossed aluminium painted profile for fixing to the tubular steel worktop.

Colours: **RC** Light oak - **WE** Wengé - **NA** Ambra walnut

Panel

E1 quality melamine.

1.8cm thick with 6/10 ABS edging.

Colours: **RC** Light oak - **WE** Wengé - **NA** Ambra walnut

Modesty panels

For melamine worktops

E1 quality melamine.

1.5 mm thick with 13/10 rounded shockproof ABS edging.

Colours: **RC** Light oak - **WE** Wengé - **NA** Ambra walnut

For glass worktops

1.5 mm thick steel sheet, epoxy coated.

Colours: **Z** Embossed aluminium

Drawer unit on wheels, bearing, pedestal

Structure

E1 quality melamine.

Thickness: cm 1.8 – 2.8.

Equipped with 4 long-lasting plastic and steel wheels (drawer unit on wheels with file drawer complete with 5 wheels) or plastic and steel feet which can be levelled (bearing drawer unit - pedestal).

Colours: **W** White - **RC** Light oak - **WE** Wengé - **NA** Ambra walnut

Front parts

E1 quality melamine.

Thickness: cm 1.8 with ABS edges on all sides.

Drawer fronts equipped with simultaneous closing lock.

Internal drawers in metal complete with simple extraction guides (complete extraction for file drawer) and anti-tipping system.

Door equipped with lock and hinges with 110° opening

Colours: **W** White - **RC** Light oak - **WE** Wengé - **NA** Ambra walnut

Handles

Plastic: in moulded ABS in RAL9006 Aluminium finish

Metal: in die-cast aluminium with Chromium finish

Boiserie

Panels

E1 quality melamine.

1.8cm thick with 6/10 ABS edging with aluminium pressure die-casting profiles in a natural anodised finish to be attached to shelves.

Colours: **RC** Light oak - **WE** Wengé - **NA** Ambra walnut

Profiles to be attached to shelves / finish end profiles

Aluminium pressure die-casting in a natural anodised finish.

Wooden shelves

E1 quality melamine.

2.8cm thick with 20/10 rounded shockproof ABS edging.

Colours: **RC** Light oak - **WE** Wengé - **NA** Ambra walnut

Glass shelves

Tempered glass. 1cm thick.

Colours: **RC** Light oak - **WE** Wengé - **NA** Ambra walnut

Caractéristiques physico-mécaniques des panneaux en mélamine

Emission de formaldéhyde: E1

Épaisseurs: 1,2 - 1,8 - 2,8 cm.

Densité: 660 kg (± 3%) m3 (DIN 68763/81).

Plateaux en mélamine

Mélatiné de qualité E1.

Épaisseur: 3,8 cm avec chant en ABS 20/10 arrondi antichoc sur tous les côtés.

Coloris: **RC** Chêne clair - **WE** Wengé - **NA** Noyer ambra

Plateaux vitrés

Verre trempé et sérigraphié. Épaisseur 1,2 cm.

Coloris: **C** Transparent - **S** Satiné - **KV** Noir - **WV** Blanc

Structure métallique

Pied en aluminium gaufré

Extrudé en aluminium avec section ø 8 cm.

Plaques pour raccord au plan et au pied de nivellement en moulage sous pression d'aluminium.

Coloris: **Z** Aluminium gaufré

Structure en mélamine

Côté rectangulaire

Mélatiné de qualité E1.

Épaisseur: 3,8 cm avec chant en ABS 20/10 arrondi antichoc.

Pieds de nivellement en ABS.

Profil pour raccord au plan en tube d'acier avec finition chromé.

Coloris: **RC** Chêne clair - **WE** Wengé - **NA** Noyer ambra

Côté façonné

Mélatiné de qualité E1.

Épaisseur: 3,8 cm avec chant en ABS 20/10 arrondi antichoc.

Pieds de nivellement en ABS.

Profil pour raccord au plan en tube d'acier verni avec finition d'aluminium gaufré.

Coloris: **RC** Chêne clair - **WE** Wengé - **NA** Noyer ambra

Panneau

Mélatiné de qualité E1.

Épaisseur: 1,8 cm avec chant en ABS 6/10.

Coloris: **RC** Chêne clair - **WE** Wengé - **NA** Noyer ambra

Voile de fond

Pour plateaux en mélamine

Mélatiné de qualité E1.

Épaisseur: 1,8 cm avec chant en ABS 13/10 arrondi antichoc.

Coloris: **RC** Chêne clair - **WE** Wengé - **NA** Noyer ambra

Pour plateaux vitrés

Tôle d'acier, épaisseur 1,5 mm, en laqué époxy.

Coloris: **Z** Aluminium gaufré

Caissons à roulettes, caissons porteurs, dessertes

Structure

Mélamine, qualité E1.

Épaisseur 1,8 - 2,8 cm

Équipé de 4 roulettes plastique/acier grande durabilité (caisson à roulettes avec fichier muni d'une 5ème roulette) ou de pieds réglables, plastique et acier (caissons porteurs - dessertes).

Coloris: **W** Blanc - **RC** Chêne clair - **WE** Wengé

NA Noyer ambra

Façades

Mélamine, qualité E1.

Épaisseur 1,8 cm, avec chant en ABS sur tous les côtés.

Façades de tiroirs avec serrure à blocage simultané.

Tiroirs internes en métal sur coulisses

(extraction totale pour tiroir D.S.) et système anti-basculement.

Portes équipées de serrure et de charnières d'ouverture à 110 °

Coloris: **W** Blanc - **RC** Chêne clair - **WE** Wengé

NA Noyer ambra

Poignées

Plastique: ABS finition Aluminium RAL9006

Métal: aluminium moulé sous pression finition chromée

Boiserie

Panneaux

Mélatiné de qualité E1.

Épaisseur: 1,8 cm avec chant en ABS 6/10, dotés de profils en moulage sous pression d'aluminium en finition anodisé naturel, préparés pour l'accrochage aux étagères.

Coloris: **RC** Chêne clair - **WE** Wengé - **NA** Noyer ambra

Profils pour accrochage étagères / profils terminaux en finition

Moulage sous pression d'aluminium en finition anodisé naturel.

Étagères en bois

Mélatiné de qualité E1.

Épaisseur: 2,8 cm avec chant en ABS 20/10 arrondi antichoc.

Coloris: **RC** Chêne clair - **WE** Wengé - **NA** Noyer ambra

Étagères vitrées

Verre trempé. Épaisseur 1 cm.

Coloris: **C** Transparent - **S** Satiné - **KV** Noir - **WV** Blanc

Peso, volume e colli
Weight, volume and packages
Poids, volume et colis

Codice Code Code	Peso Weight Poids kg	Volume Volume Volume m³	Colli Packages Colis n°	Codice Code Code	Peso Weight Poids kg	Volume Volume Volume m³	Colli Packages Colis n°	Codice Code Code	Peso Weight Poids kg	Volume Volume Volume m³	Colli Packages Colis n°
3849	28	0,15	1	48092	65	0,215	4	48381	95	0,16	3
3850	25	0,15	1	48094	7	0,02	2	48383	90	0,16	4
13776	0,15	0,002	1	48096	4	0,012	1	48391	95	0,12	3
13777	0,15	0,002	1	48097	5	0,015	1	48392	93	0,12	4
13780	1,3	0,01	1	48098	5	0,015	1	48395	95	0,21	3
43680	0,01	0,001	1	48101	25,5	0,07	1	56291	29,2	0,16	2
48001	78	0,245	3	48102	31	0,08	1	56292	30	0,16	2
48002	85	0,258	3	48111	48,5	0,21	3	56294	28,2	0,16	2
48011	78	0,245	3	48112	53,5	0,22	3	56295	28,5	0,16	2
48012	85	0,258	3	48115	48,5	0,21	3	56305	0,1	0,001	1
48021	48,5	0,21	3	48116	53,5	0,22	3	56311	25,2	0,181	2
48022	53,5	0,22	3	48120	92	0,39	3	56312	26	0,181	2
48031	48,5	0,21	3	48121	48	0,19	3	56313	24,2	0,181	2
48032	53,5	0,22	3	48125	92	0,39	3	56321	51,2	0,51	2
48041	46	0,21	4	48126	48	0,19	3	56322	51,2	0,51	2
48042	51	0,22	4	48130	39	0,16	3	56323	51,5	0,51	2
48061	17	0,04	3	48135	44	0,17	3	56324	51,5	0,51	2
48065	17	0,04	3	48136	39	0,14	3	56326	55,2	0,51	2
48067	22	0,07	3	48140	67	0,215	3	56327	55,2	0,51	2
48068	22	0,07	3	48145	62	0,185	3	56328	55,5	0,51	2
48071	82	0,173	3	48150	60	0,16	3	56329	55,5	0,51	2
48072	101	0,27	8	48155	50	0,28	6	56330	54,2	0,51	2
48073	101	0,27	8	48156	92	0,41	9	56331	54,2	0,51	2
48074	50	0,13	3	48251	44	0,09	2	56332	55	0,51	2
48077	80	0,173	4	48255	45	0,075	6	56333	55	0,51	2
48078	81	0,25	6	48260	1	0,01	2				
48079	81	0,25	6	48321	58	0,15	3				
48081	56,5	0,145	3	48322	64	0,18	3				
48083	51	0,145	4	48341	56	0,15	4				
48084	17	0,04	3	48342	62	0,18	4				
48085	17	0,04	3	48374	95	0,21	3				
48091	67	0,215	3	48377	93	0,21	4				

13 **Scrivanie e tavoli riunione**

Desks and meeting tables
Bureaux et tables réunion

14 **Modesty panels**

Modesty panels
Voiles de fond

15 **Serventi / Cassettiere**

Pedestals / Drawer units
Dessertes / Caissons

18 **Boiserie**

Boiseries
Boiseries

Scrivanie e tavoli riunione

Desks and meeting tables

Bureaux et tables réunion

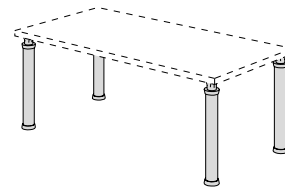
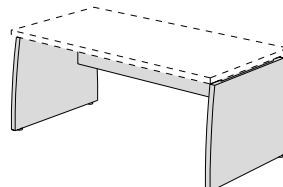
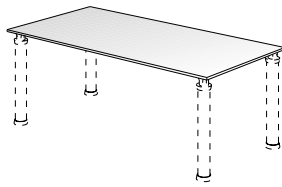
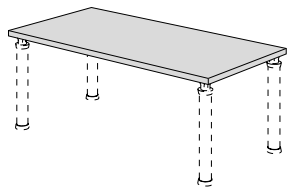

Piano nobilitato

Melamine worktop

Plateau en mélamine

Piano vetro

Glass worktop

Plateau en verre

Struttura nobilitato

Melamine structure

Structure en mélamine

Struttura metallo

Metal structure

Structure en métal

RC Rovere chiaro
Light oak
Chêne clair

C Trasparente
Transparent
Transparent

RC Rovere chiaro
Light oak
Chêne clair

Z Alluminio gofrato
Embossed aluminium
Aluminium gaufré

WE Wengé
Wengé
Wengé

S Satinato
Satinéd
Satiné

WE Wengé
Wengé
Wengé

NA Noce ambra
Ambra walnut
Noyer ambra

KW Nero
Black
Noir

NA Noce ambra
Ambra walnut
Noyer ambra

WV Bianco
White
Blanc

Per una corretta compilazione dell'ordine bisogna indicare:
- colore piano/pannello
- codice prodotto
- colore fianchi

Compilation of the order must indicate:
- colour of the worktop/modesty panel
- product code
- colour of the panel legs

Pour rédiger la commande il faut indiquer:
- coloris plateau/voile de fond
- code produit
- coloris piétement plein

Esempio:
Scrivania serie "trapezio" 203x100 con piano in nobilitato wengé e struttura in metallo alluminio gofrato

Example:
203x100cm "trapezoidal" series desk with Wengé melamine worktop and embossed aluminium structure

Exemple:
Bureau série "trapézoïdal" 203x100 cm avec plateau en mélamine wengé et structure en aluminium gaufré

- Sigla piano wengé **WE**
- Codice prodotto **48074**
- Sigla struttura **Z**

- Wengé worktop **WE**
- Code **48074**
- Structure **Z**

- Plateau wengé **WE**
- Code **48074**
- Structure **Z**

Modesty panels

Modesty panels

Voiles de fond

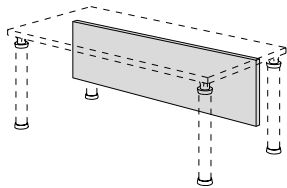

Modesty panels

Modesty panels

Voiles de fond

RC Rovere chiaro
Light oak
Chêne clair

WE Wengé
Wengé
Wengé

NA Noce ambra
Ambra walnut
Noyer ambra

Per una corretta
compilazione dell'ordine
bisogna indicare:
- colore modesty panel
- codice prodotto

Esempio:
Modesty panel cm 150x35
in nobilitato wengé

- Sigla colore modesty
panel **WE**
- Codice prodotto **48094**

Compilation of the order
must indicate:
- modesty panel colour
- product code

Example:
150x35cm Canaletto
wengé melamine modesty
panel

- Modesty panels colour
WE
- Code **48094**

Pour rédiger la commande
il faut indiquer:
- coloris voile de fond
- code produit

Exemple:
Voile de fond 150x35 cm en
mélamine wengé

- Coloris voile de fond **WE**
- Code **48094**

Cassettiere su ruote, cassettiere portanti, serventi

Drawer units on wheels, bearing, pedestals

Caissons à roulettes, caissons porteurs, dessertes

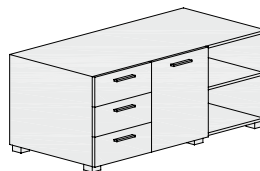
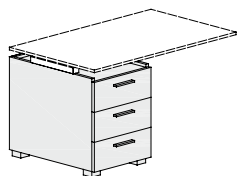
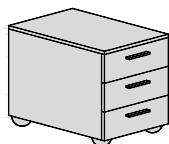

Struttura/frontale

Structure/front
Structure/façade

W Bianco
White
Blanc

RC Rovere chiaro
Light oak
Chêne clair

WE Wenge
Wenge
Wengé

NA Noce ambra
Ambra walnut
Noyer ambra

Struttura/frontale

Structure/front
Structure/façade

W Bianco
White
Blanc

RC Rovere chiaro
Light oak
Chêne clair

WE Wenge
Wenge
Wengé

NA Noce ambra
Ambra walnut
Noyer ambra

Struttura/frontale

Structure/front
Structure/façade

W Bianco
White
Blanc

RC Rovere chiaro
Light oak
Chêne clair

WE Wenge
Wenge
Wengé

NA Noce ambra
Ambra walnut
Noyer ambra

Per una corretta compilazione dell'ordine bisogna indicare:

- **colore struttura/frontale**
- **codice prodotto**

Esempio:
Cassettiera su ruote 3
cassetti in metallo in
nobilitato bianco

Sigla colore struttura/
frontali **W**
Codice prodotto **56301**

To correctly complete the order you must indicate:

- **structure/front colour**
- **product code**

Example:
Drawer unit on wheels, 3
metal drawers melamine
white

Structure/front colour
code **W**
Product code **56301**

Pour remplir correctement le formulaire de la commande, indiquer:

- **la couleur de la structure/façade**
- **le code du produit**

Exemple:
Caisson à roulettes 3
 tiroirs en métal, mélaminé
blanc

Abréviation couleur
structure /façades **W**
Code du produit **56301**

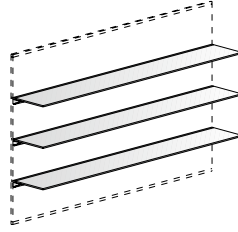
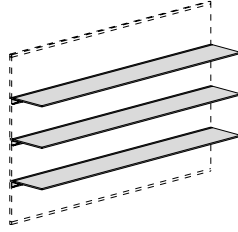
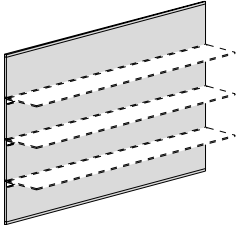

Pannello nobilitato
Melamine panel
Panneau en mélamine

RC Rovere chiaro
Light oak
Chêne clair

WE Wengé
Wengé
Wengé

NA Noce ambra
Ambra walnut
Noyer ambra

Mensola nobilitato
Melamine shelf
Etagère en mélamine

RC Rovere chiaro
Light oak
Chêne clair

WE Wengé
Wengé
Wengé

NA Noce ambra
Ambra walnut
Noyer ambra

Mensola vetro
Glass shelf
Etagère vitrée

C Trasparente
Transparent
Transparent

S Satinato
Satinéd
Satine

KV Nero
Black
Noir

WV Bianco
White
Blanc

Per una corretta
compilazione dell'ordine
bisogna indicare:
- colore prodotto
- codice prodotto

Esempio:
Modulo boiserie h 164.5 in
nobilitato rovere chiaro

- Sigla colore **RC**
- Codice prodotto **48251**

Compilation of the order
must indicate:
- product colour
- product code

Exemple:
H 164.5 light oak
melamine boiserie module

- Colour **RC**
- Code **48251**

Pour rédiger la commande
il faut indiquer:
- coloris produit
- code produit

Exemple:
Module boiserie H 164,5 en
mélamine chêne clair

- Coloris **RC**
- Code **48251**

ELEMENTO

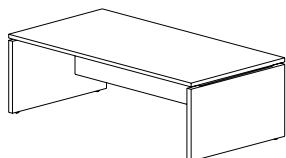

ANGOLI DIRITTI
 STRAIGHT CORNERS
 COINS DROITS

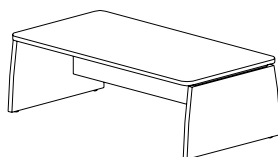

ANGOLI ARROTONDATI
 ROUNDED CORNERS
 COINS ARRONDIS

DESCRIZIONE

Scrivania con struttura nobilitata
 Desk with melamine structure
 Bureau avec structure en mélamine

		Piano nobilitato Melamine worktop / Plateau en mélamine			
		RC	WE	NA	
ANGOLI DIRITTI STRAIGHT CORNERS COINS DROITS	MISURA				
	CODICE				
	175x90	48001	645,00	645,00	645,00
	200x90	48002	675,00	675,00	675,00
ANGOLI ARROTONDATI ROUNDED CORNERS COINS ARRONDIS	175x90	48011	645,00	645,00	645,00
	200x90	48012	675,00	675,00	675,00

ELEMENTO

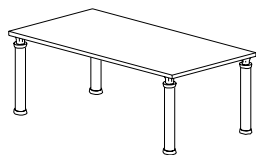

DESCRIZIONE

Scrivania con struttura metallo

Desk with metal structure

Bureau avec structure en métal

Piano nobilitato
 Melamine worktop / Plateau en mélamine

Struttura metallo: Z (alluminio)
 Metal structure: Z (aluminium)
 Structure en métal: Z (aluminium)

MISURA	CODICE	RC	WE	NA					
ANGOLI DIRITTI STRAIGHT CORNERS COINSARRONDIS	175x90	48021	600,00	600,00	600,00				
	200x90	48022	626,00	626,00	626,00				
ANGOLI ARROTONDATI ROUNDED CORNERS COINS ARRONDIS	175x90	48031	600,00	600,00	600,00				
	200x90	48032	626,00	626,00	626,00				

ELEMENTO

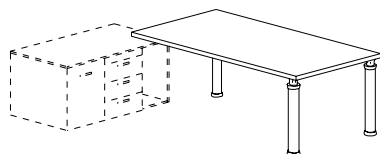

DESCRIZIONE

**Scrivania con struttura metallo predisposta per servente portante
(Può essere montata destra o sinistra)
(Ordinare servente pag. 31)**

Desk with metal structure predisposed for bearing pedestal
(It can be fixed to the right or to the left)
(Order pedestal page 31)

Bureau avec structure en métal équipé pour desserte porteuse
(Peut être monté à droite ou à gauche)
(Commander desserte page 31)

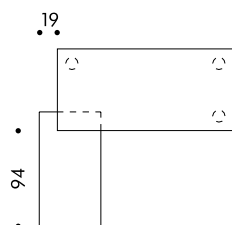

Piano nobilitato Melamine worktop / Plateau en mélamine							
Struttura metallo: Z (alluminio) Metal structure: Z (aluminium) Structure en métal: Z (aluminium)							
RC	WE	NA					

	MISURA	CODICE							
ANGOLI DIRITTI STRAIGHT CORNERS COINSARRONDIS	175x90	48041	580,00	580,00	580,00				
	200x90	48042	606,00	606,00	606,00				
ANGOLI ARROTONDATI ROUNDED CORNERS COINS ARRONDIS	175x90	48051	580,00	580,00	580,00				
	200x90	48052	606,00	606,00	606,00				

ELEMENTO

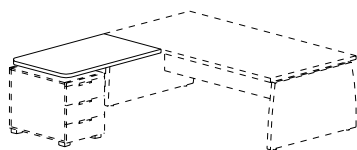

DESCRIZIONE

Allungo rettangolare predisposto per cassetiera portante (può essere montato destro o sinistro ed è applicabile su scrivanie rettangolari con struttura nobilitato o metallo) (ordinare cassetiera pag. 30)

Rectangular return top predisposed for bearing drawer unit (it can be fixed to the right or to the left and used on rectangular desktops with metal or melamine structure) (order drawer unit page 30)

Retour rectangulaire équipé pour caisson porteur (peut être monté à droite ou à gauche et utilisé en cas de bureaux rectangulaires avec structure en mélaminé ou en métal) (commander caisson page 30)

		Piano nobilitato Melamine worktop / Plateau en mélamine							
		Struttura metallo: Z (alluminio) Metal structure: Z (aluminium) Structure en metal: Z (aluminium)							
		RC	WE	NA					
MISURA	CODICE								
ANGOLI DIRITTI STRAIGHT CORNERS COINS ARRONDIS	100x60 48061	210,00	210,00	210,00					
ANGOLI ARROTONDATI ROUNDED CORNERS COINS ARRONDIS	100x60 48065	210,00	210,00	210,00					

ELEMENTO

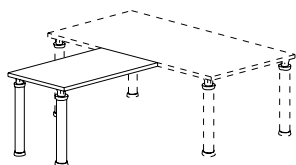

DESCRIZIONE

Allungo rettangolare per riunioni
(applicabile su scrivanie rettangolari con struttura nobilitato o metallo)
 Rectangular return top for meeting tables
 (To be used with rectangular metal or melamine desktops)
 Retour rectangulaire pour tables reunion
 (peut être utilisé en cas de bureaux rectangulaires avec structure en mélamine ou en métal)

		Piano nobilitato Melamine worktop / Plateau en mélamine							
		Struttura metallo: Z (alluminio) Metal structure: Z (aluminium) Structure en métal: Z (aluminium)							
		RC	WE	NA					
	MISURA	CODICE							
ANGOLI DIRITTI STRAIGHT CORNERS COINSARRONDIS	100x60	48067	310,00	310,00	310,00				
ANGOLI ARROTONDATI ROUNDED CORNERS COINS ARRONDIS	100x60	48068	310,00	310,00	310,00				

ELEMENTO

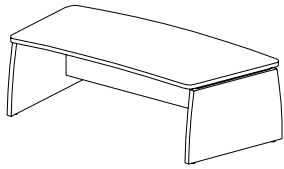

DESCRIZIONE

Scrivania con struttura nobilitata
 Desk with melamine structure
 Bureau avec structure en mélamine

		Piano nobilitato Melamine worktop / Plateau en mélamine			
		RC	WE	NA	
MISURA	CODICE				
203x100	48071	777,00	777,00	777,00	

ELEMENTO

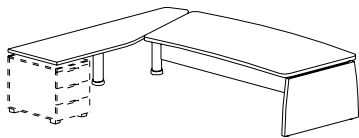

DESCRIZIONE

Scrivania con struttura mista e complanare predisposta per cassetiera portante (il disegno si riferisce alla scrivania SX) (ordinare cassetiera pag. 30)
 Desk with mixed structure and return top predisposed for bearing drawer unit (SX illustrated) (order drawer unit page 30)
 Bureau avec structure mixte et retour équipé pour caisson porteur (le dessin se réfère au bureau SX) (commander caisson page 30)

		Piano nobilitato Melamine worktop / Plateau en mélamine			
		Struttura metallo: Z (alluminio) Metal structure: Z (aluminium) Structure en métal: Z (aluminium)			
		RC	WE	NA	
MISURA	CODICE				
230x210	DX48072	1.194,00	1.194,00	1.194,00	
	SX48073				

H73.5

Scrivania serie "trapezio" "Trapezoidal" series desks Bureaux série "trapézoïdale"

ELEMENTO

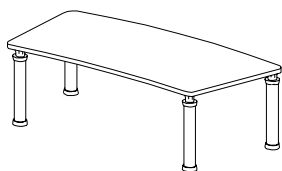

DESCRIZIONE

Scrivania con struttura metallo
Desk with metal structure
Bureau avec structure en métal

		Piano nobilitato Melamine worktop / Plateau en mélamine				
		Struttura metallo: Z (alluminio) Metal structure: Z (aluminium) Structure en métal: Z (aluminium)				
		RC	WE	NA		
MISURA	CODICE					
203x100	48074	767,00	767,00	767,00		

ELEMENTO

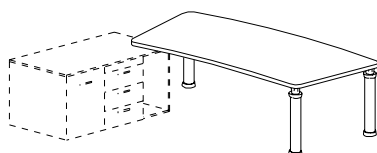

DESCRIZIONE

Scrivania con struttura metallo predisposta per servente portante (può essere montata destra o sinistra) (ordinare servente pag. 31)
Desk with metal structure predisposed for bearing pedestal (it can be fixed to the right or to the left) (order pedestal page 31)
Bureau avec structure en métal équipé pour desserte porteuse (peut être monté à droite ou à gauche) (commander desserte page 31)

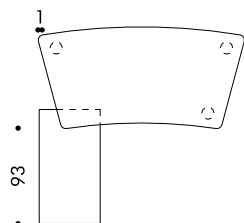

		Piano nobilitato Melamine worktop / Plateau en mélamine				
		Struttura metallo: Z (alluminio) Metal structure: Z (aluminium) Structure en métal: Z (aluminium)				
		RC	WE	NA		
MISURA	CODICE					
203x100	48077	747,00	747,00	747,00		

ELEMENTO

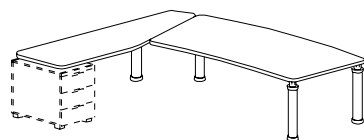

DESCRIZIONE

Scrivania con struttura metallo e complanare predisposta per cassetteria portante (il disegno si riferisce alla scrivania SX) (ordinare cassetteria pag. 30)
 Desk with metal structure and return top predisposed for bearing drawer unit (SX illustrated) (order drawer unit page 30)
 Bureau avec structure en métal et retour équipé pour caisson porteur (le dessin se réfère au bureau SX) (commander caisson page 30)

		Piano nobilitato Melamine worktop / Plateau en mélamine						
		Struttura metallo: Z (alluminio) Metal structure: Z (aluminium) Structure en métal: Z (aluminium)						
		RC	WE	NA				
MISURA	CODICE							
203x100	DX48078 SX48079	1.093,00	1.093,00	1.093,00				

H73.5

Scrivanie serie "ovale" "Oval" series desks Bureaux série "ovale"

ELEMENTO

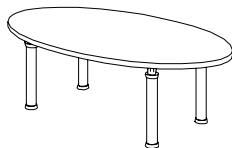

DESCRIZIONE

Scrivania con struttura metallo
Desk with metal structure
Bureau avec structure en métal

		Piano nobilitato Melamine worktop / Plateau en mélamine						
		Struttura metallo: Z (alluminio) Metal structure: Z (aluminium) Structure en métal: Z (aluminium)						
		RC	WE	NA				
MISURA	CODICE							
210x120	48081	748,00	748,00	748,00				

ELEMENTO

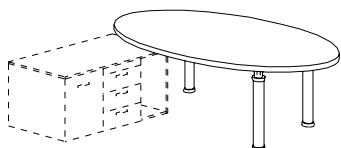

DESCRIZIONE

Scrivania con struttura metallo predisposta per servente portante (può essere montata destra o sinistra) (ordinare servente pag. 31)
Desk with metal structure predisposed for bearing pedestal (it can be fixed to the right or to the left) (order pedestal page 31)
Bureau avec structure en métal équipé pour desserte porteuse (peut être monté à droite ou à gauche) (commander desserte page 31)

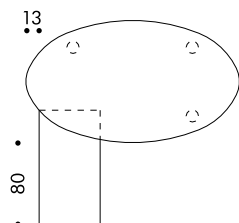

		Piano nobilitato Melamine worktop / Plateau en mélamine / Superficie melaminica						
		Struttura metallo: Z (alluminio) Metal structure: Z (aluminium) Structure en métal: Z (aluminium)						
		RC	WE	NA				
MISURA	CODICE							
210x120	48083	764,00	764,00	764,00				

ELEMENTO

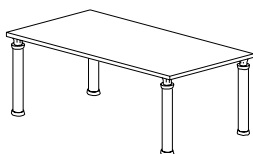

DESCRIZIONE

Tavolo riunione rettangolare
Rectangular meeting table
Table réunion rectangulaire

		Piano nobilitato Melamine worktop / Plateau en mélamine							
		Struttura metallo: Z (alluminio) Metal structure: Z (aluminium) Structure en métal: Z (aluminium)							
		RC	WE	NA					
	MISURA	CODICE							
ANGOLI DIRITTI STRAIGHT CORNERS COINS ARRONDIS	175x90	48111	600,00	600,00	600,00				
	200x90	48112	626,00	626,00	626,00				
ANGOLI ARROTONDATI ROUNDED CORNERS COINS ARRONDIS	175x90	48115	600,00	600,00	600,00				
	200x90	48116	626,00	626,00	626,00				

ELEMENTO

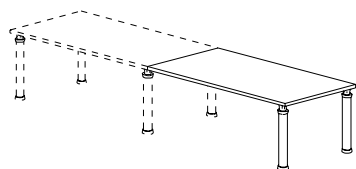

DESCRIZIONE

Allungo per tavolo riunione rettangolare
Extension for rectangular meeting table
Rallonge pour table réunion rectangulaire

		Piano nobilitato Melamine worktop / Plateau en mélamine						
		Struttura metallo: Z (alluminio) Metal structure: Z (aluminium) Structure en métal: Z (aluminium)						
		RC	WE	NA				
MISURA	CODICE							
ANGOLI DIRITTI STRAIGHT CORNERS COINS ARRONDIS	175x90	48120	422,00	422,00	422,00			
	200x90	48121	448,00	448,00	448,00			
ANGOLI ARROTONDATI ROUNDED CORNERS COINS ARRONDIS	175x90	48125	422,00	422,00	422,00			
	200x90	48126	448,00	448,00	448,00			

ELEMENTO

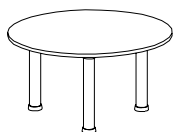

DESCRIZIONE

Tavolo riunione rotondo
Round meeting table
Table réunion ronde

		Piano nobilitato Melamine worktop / Plateau en mélamine						
		Struttura metallo: Z (alluminio) Metal structure: Z (aluminium) Structure en métal: Z (aluminium)						
		RC	WE	NA				
MISURA	CODICE							
Ø120	48130	485,00	485,00	485,00				

		Piano vetro Glass worktop / Plateau vitré						
		Struttura metallo: Z (alluminio) Metal structure: Z (aluminium) Structure en métal: Z (aluminium)						
		C	S	KV	WV			
MISURA	CODICE							
Ø120	48395	1.039,00	1.157,00	1.214,00	1.399,00			

ELEMENTO

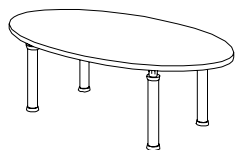

DESCRIZIONE

Tavolo riunione ovale
Oval meeting table
Table réunion ovale

		Piano nobilitato Melamine worktop / Plateau en mélamine						
		Struttura metallo: Z (alluminio) Metal structure: Z (aluminium) Structure en métal: Z (aluminium)						
		RC	WE	NA				
MISURA	CODICE							
210x120	48150	784,00	784,00	784,00				

H73.5

Tavoli riunione Meeting tables Tables réunion

ELEMENTO

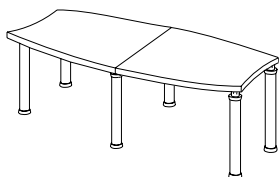

DESCRIZIONE

Tavolo riunione sagomato
Shaped meeting table
Table réunion façonnée

		Piano nobilitato Melamine worktop / Plateau en mélamine						
		Struttura metallo: Z (alluminio) Metal structure: Z (aluminium) Structure en métal: Z (aluminium)						
		RC	WE	NA				
MISURA	CODICE							
300x120	48155	1.076,00	1.076,00	1.076,00				

ELEMENTO

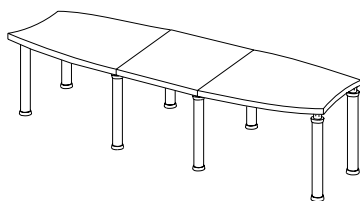

DESCRIZIONE

Tavolo riunione sagomato
Shaped meeting table
Table réunion façonnée

		Piano nobilitato Melamine worktop / Plateau en mélamine						
		Struttura metallo: Z (alluminio) Metal structure: Z (aluminium) Structure en métal: Z (aluminium)						
		RC	WE	NA				
MISURA	CODICE							
300x120	48155	1.076,00	1.076,00	1.076,00				

Zona di attesa
 Waiting area
 Zone d'accueil

ELEMENTO

DESCRIZIONE

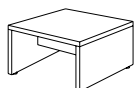

Tavolo fumo H 42 con struttura nobilitato
 H 42 smoking table with melamine structure
 Table basse H 42 avec structure en mélamine

Piano nobilitato
 Melamine worktop / Plateau en mélamine

MISURA	CODICE	RC	WE	NA	
60x60	48101	168,00	168,00	168,00	
100x60	48102	201,00	201,00	201,00	

Modesty panels
Modesty panels
Voiles de fond

ELEMENTO

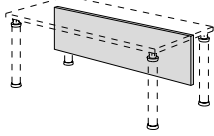

DESCRIZIONE

Modesty panel per scrivanie con piano nobilitato, serie "rettangolare" - "trapezio" - "ovale"

Modesty panel for "rectangular - trapezoidal - oval" series desks with melamine worktop

Voile de fond pour bureaux avec plateau en mélaminé série "rectangulaire - trapézoïdale - ovale"

		Nobilitato Melamine / Mé laminé			
		RC	WE	NA	
MISURA	CODICE				
150x35	48094	74,00	74,00	74,00	

ELEMENTO

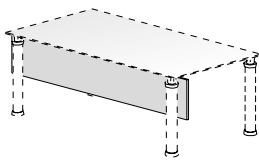

DESCRIZIONE

Modesty panel per scrivanie con piano vetro, serie "rettangolare" - "trapezio"

Modesty panel for "rectangular - trapezoidal" series desks with glass worktop

Voile de fond pour bureaux avec plateau vitre serie "rectangulaire - trapézoïdale"

		Metallo Metal / Métal			
		Z			
MISURA	CODICE				
RETTANGOLARE cm 175 RECTANGULAR RECTANGULAIRE	161x40 48096	184,00			
RETTANGOLARE cm 200 RECTANGULAR RECTANGULAIRE	186x40 48097	192,00			
TRAPEZIO cm 203 TRAPEZOIDAL TRAPEZOÏDALE	187x40 48098	193,00			

ELEMENTO

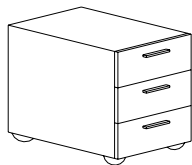

DESCRIZIONE

Cassettiera con 3 cassetti interni in metallo (viene fornita già assemblata)

Drawer unit with 3 internal metal drawers (comes already assembled)

Caisson 3 tiroirs internes en métal (livré déjà assemblé)

MANIGLIA IN PLASTICA RAL 9006
RAL 9006 PLASTIC HANDLE
POIGNEE EN PLASTIQUE RAL 9006

MANIGLIA IN METALLO ECOCROMO
ECO-CHROME METAL HANDLE
POIGNEE EN METAL ECO CHROME

MISURA	CODICE	Nobilitato / Melamine / Mèlamine					
		W	RC	WE	NA		
39,5x60	56301	270,00	270,00	270,00	270,00		
39,5x60	56302	279,00	279,00	279,00	279,00		

ELEMENTO

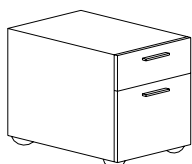

DESCRIZIONE

Cassettiera con cassetto e schedario in metallo (viene fornita già assemblata)

Drawer unit with drawer and metal file drawer (comes already assembled)

Caisson avec tiroir et fichier métal (livré déjà assemblé)

MANIGLIA IN PLASTICA RAL 9006
RAL 9006 PLASTIC HANDLE
POIGNEE EN PLASTIQUE RAL 9006

MANIGLIA IN METALLO ECOCROMO
ECO-CHROME METAL HANDLE
POIGNEE EN METAL ECO CHROME

MISURA	CODICE	Nobilitato / Melamine / Mèlamine					
		W	RC	WE	NA		
39,5x60	56303	293,00	293,00	293,00	293,00		
39,5x60	56304	302,00	302,00	302,00	302,00		

ELEMENTO

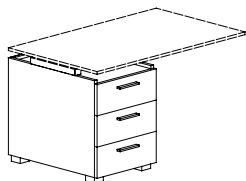

DESCRIZIONE

Cassettiera con 3 cassetti interni in metallo (viene fornita già assemblata)

Drawer unit with 3 internal metal drawers (comes already assembled)

Caisson 3 tiroirs internes en métal (livré déjà assemblé)

		Nobilitato / Melamine / Mélamine					
MISURA	CODICE	W	RC	WE	NA		
MANIGLIA IN PLASTICA RAL 9006 RAL 9006 PLASTIC HANDLE POIGNEE EN PLASTIQUE RAL 9006	39,5x60 56311	340,00	340,00	340,00	340,00		
MANIGLIA IN METALLO ECOCROMO ECO-CHROME METAL HANDLE POIGNEE EN METAL ECO CHROME	39,5x60 56312	352,00	352,00	352,00	352,00		

ELEMENTO

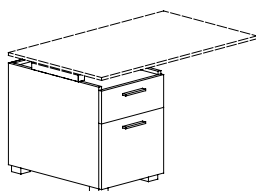

DESCRIZIONE

Cassettiera con cassetto e schedario in metallo (viene fornita già assemblata)

Drawer unit with drawer and metal file drawer (comes already assembled)

Caisson avec tiroir et fichier métal (livré déjà assemblé)

		Nobilitato / Melamine / Mélamine					
MISURA	CODICE	W	RC	WE	NA		
MANIGLIA IN PLASTICA RAL 9006 RAL 9006 PLASTIC HANDLE POIGNEE EN PLASTIQUE RAL 9006	39,5x60 56313	326,00	326,00	326,00	326,00		
MANIGLIA IN METALLO ECOCROMO ECO-CHROME METAL HANDLE POIGNEE EN METAL ECO CHROME	39,5x60 56314	333,00	333,00	333,00	333,00		

ELEMENTO

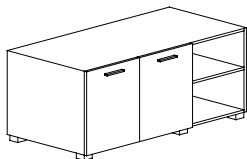

MISURA	CODICE
120x60	DX 56321
	SX 56322
120x60	DX 56323
	SX 56324

MANIGLIA IN PLASTICA RAL 9006
RAL 9006 PLASTIC HANDLE
POIGNEE EN PLASTIQUE RAL 9006

MANIGLIA IN METALLO ECOCROMO
ECO-CHROME METAL HANDLE
POIGNEE EN METAL ECO CHROME

DESCRIZIONE

Servente monofacciale con 2 ante e vano a giorno (viene fornito già assemblato) (il disegno si riferisce al servente SX)

Single sided pedestal with 2 doors and open shelf (comes already assembled) (the drawing refers to the SX pedestal)

Desserte à une seule façade avec 2 portes et un espace ouvert (produit livré déjà assemblé) (le schéma se rapporte à la desserte SX)

Nobilitato / Melamine / Mélamine

MISURA	CODICE	W	RC	WE	NA		
120x60	DX 56321	433,00	433,00	433,00	433,00		
	SX 56322						
120x60	DX 56323	442,00	442,00	442,00	442,00		
	SX 56324						

ELEMENTO

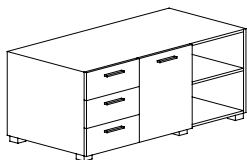

MISURA	CODICE
120x60	DX 56326
	SX 56327
120x60	DX 56328
	SX 56329

MANIGLIA IN PLASTICA RAL 9006
RAL 9006 PLASTIC HANDLE
POIGNEE EN PLASTIQUE RAL 9006

MANIGLIA IN METALLO ECOCROMO
ECO-CHROME METAL HANDLE
POIGNEE EN METAL ECO CHROME

DESCRIZIONE

Servente monofacciale con anta, 3 cassetti in metallo e vano a giorno (viene fornito già assemblato) (il disegno si riferisce al servente SX)

Single sided pedestal with door, 3 metal drawers and an open shelf (comes already assembled) (the drawing refers to the SX pedestal)

Desserte à une seule façade avec porte, 3 tiroirs en métal et compartiment ouvert (produit livré déjà assemblé) (le schéma se rapporte à la desserte SX)

Nobilitato / Melamine / Mélamine

MISURA	CODICE	W	RC	WE	NA		
120x60	DX 56326	593,00	593,00	593,00	593,00		
	SX 56327						
120x60	DX 56328	601,00	601,00	601,00	601,00		
	SX 56329						

ELEMENTO

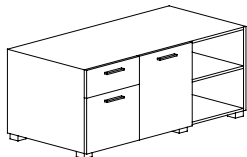

MISURA	CODICE
120x60	DX 56330
	SX 56331
120x60	DX 56332
	SX 56333

MANIGLIA IN PLASTICA RAL 9006
RAL 9006 PLASTIC HANDLE
POIGNEE EN PLASTIQUE RAL 9006

MANIGLIA IN METALLO ECOCROMO
ECO-CHROME METAL HANDLE
POIGNEE EN METAL ECO CHROME

DESCRIZIONE

Servente monofacciale con anta, cassetto schedario in metallo e vano a giorno (viene fornito già assemblato) (il disegno si riferisce al servente SX)

Single sided pedestal with door, metal file drawer and an open shelf (comes already assembled) (the drawing refers to the SX pedestal)

Desserte à une seule façade avec porte, tiroir fichier en métal et compartiment ouvert (produit livré déjà assemblé) (le schéma se rapporte à la desserte SX)

Nobilitato / Melamine / Mélamine

MISURA	CODICE	W	RC	WE	NA		
120x60	DX 56330	551,00	580,00	580,00	580,00		
	SX 56331						
120x60	DX 56332	563,00	592,00	592,00	592,00		
	SX 56333						

ELEMENTO

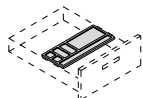

DESCRIZIONE

Vaschetta porta cancelleria
 Office supply tray
 Plumier

MISURA		CODICE	C				
		56305	4,00				

Plastica / Plastic / Plastique

ELEMENTO

DESCRIZIONE

Maggiorazione per sistema di rientro ammortizzato per cassette (prezzo per ogni cassetto). N.b.: funzionamento con portata massima di 20kg per cassetto
N.b.: in presenza di pavimenti con moquette, nelle cassettiere su ruote, il sistema di ammortizzatori non funziona per il cassetto schedario (attrito tra 5° ruota e pavimento)
 Extra charge for soft closing hinges (price for each drawer)
 Note: operational guaranteed with a maximum of 20 Kg weight per drawer
 Note: when using drawer units on castors on carpet flooring the soft closing mechanism cannot be applied to the file drawer due to the friction between the 5th wheel and the carpet
 Supplément pour système de fermeture en douceur des tiroirs (prix pour chaque tiroir)
 NB: fonctionnement avec charge max. de 20 kg par tiroir
 NB: Sur la moquette, pour les caisson à roulettes, le système d'amortissement ne fonctionne pas pour le tiroir fichier (frottement de la 5ème roulette sur le plancher)

MISURA		CODICE	C				
			10,00				

Boiserie
Boiseries
Boiseries

ELEMENTO

DESCRIZIONE

Per ottenere varie composizioni, i moduli Boiserie possono essere agganciati tra loro e/o abbinati ai contenitori H 165.5.

In order to create a variety of different compositions the "boiserie" modules can be attached to one another and/or matched to the H 165.5 storage unit.

Afin de créer une variété de différentes compositions, les modules "boiserie" peuvent être accrochés entre eux et/ou associés à l'armoire H 165,5.

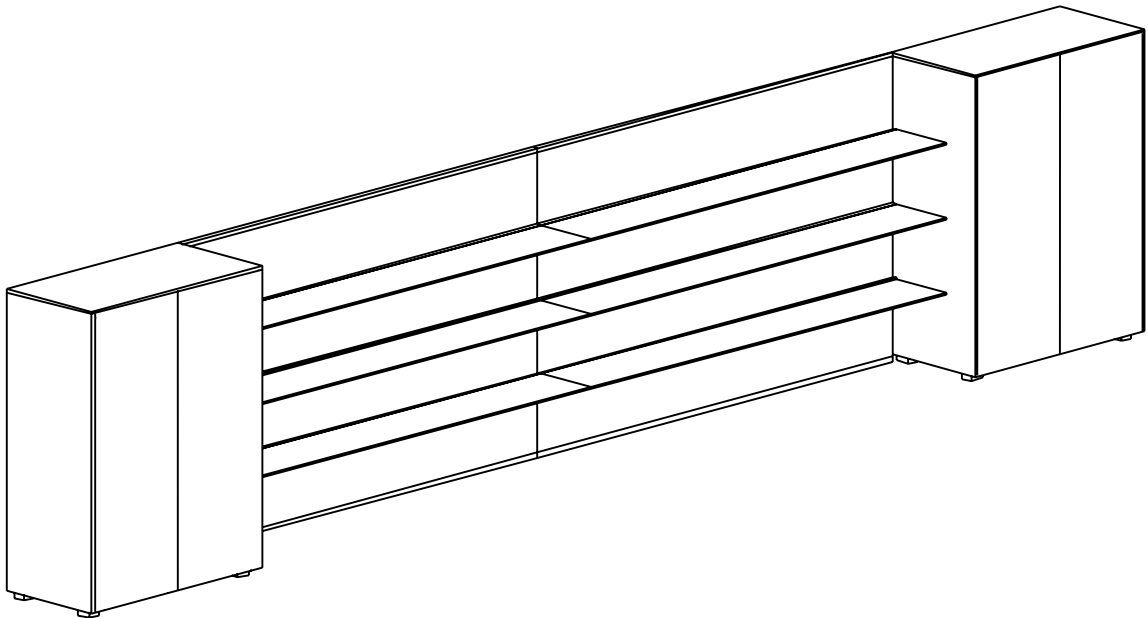

ELEMENTO

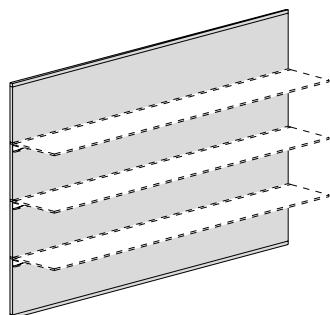

DESCRIZIONE

Modulo singolo boiserie H164.5 predisposto per l'aggancio di 3 mensole
Completo di ferramenta per fissaggio a muro
 H 164.5 Single boiserie module predisposed for fixing of 3 shelves
 with hardware for wall fixing
 Module boiserie simple H 164,5 équipé pour accrochage aux 3 étagères
 avec ferrure pour fixation au mur

MISURA CODICE

200x2.2 **48251**

Nobilitato Melamine / Mé laminé			
RC	WE	NA	
841,00	841,00	841,00	

ELEMENTO

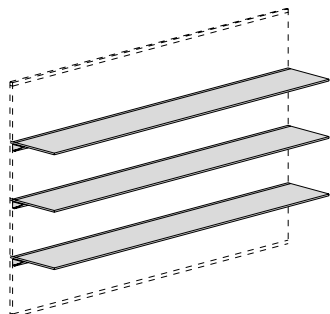

DESCRIZIONE

N. 3 mensole complete di profili alluminio per aggancio al modulo boiserie
(Portata massima 40 kg uniformemente distribuiti)
 3 Shelves with aluminium profiles to be attached to the boiserie module
 (Max 40kg capacity evenly distributed)
 3 Étagères avec profils d'aluminium pour accrochage au module boiserie
 (Portée 40 kg uniformément répartis)

MISURA CODICE

200x33 **48255**

Nobilitato Melamine / Mé laminé			
RC	WE	NA	
609,00	609,00	609,00	

MISURA CODICE

200x33 **48255**

Vetro Glass / Vitre			
C trasparente transparent transparent	S satinato satined satine	KV nero black noir	WV bianco white blanc
930,00	1.320,00	1.387,00	1.524,00

ELEMENTO

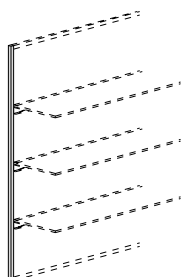

DESCRIZIONE

Cornice terminale singola H 164.5
H 164.5 Single end frame
Cadre terminal simple H 164,5

Metallo
Metal / Métal

MISURA CODICE

1,2x2,2

48260

Z

82,00